



<http://www.ebiz-tcf.eu>

**DRAFT**

**IMPLEMENTATION GUIDE**

**TRANSACTION "FASHION COMMISSION ORDER"**

Version: draft

Date of release: 17/5/2019

Document code: G040

technical Documentation: <http://www.ebiz.enea.it>

XML Schemas repository: <http://www.ebiz.enea.it/moda-ml/repository/schema/draft/default.asp>

Guides repository: <http://www.ebiz.enea.it/moda-ml/repository/guide/draft/default.asp>

Guide filename: G040-eBIZ-FashionCommissionOrder.pdf

## 0. PREMISE

This document contains a proposal for the updating and extension of eBIZ specifications starting from the eBIZ version released as CEN CWA 16667 in 2013. Under the name of 'Draft version' it is reported the result of an extensive work of analysis and consultation aimed at developing and maintaining eBIZ specifications.

In particular, the content of this proposal is the result of various activities, mainly those carried out within the framework of the **eBIZ 4.0 project** funded by the European Commission, call COS-DESIGN-2015-3-06, topic COS-2015-DESIGN-2.

The technical contents are backwards compatible with the latest official published version.

## 1. BUSINESS DESCRIPTION

### 1.1 Scope

This guide is intended to illustrate the standard XML form of the "FASHION COMMISSION ORDER" document type to companies in the fashion sector, providing instructions for their use in the electronic commerce context between fashion subcontractors and their customers as illustrated in the enclosed diagram

All the rules necessary for the construction and validation of the document are expressed through a specific XML schema, which is presented in detail in paragraph 3.

### 1.2 Generalities

The FASHION Commission Order is used by the commissioner Company to commit to a Sub-contractor

Each commission order can include one or more operations of the manufacturing cycle, each one corresponding to a line item

The document can be used either to order the manufacturing of finished goods or of component parts of them.

When the Commissioner orders a sequence of operations to different Sub-contractors, he can use this document also to dispose the delivering of semifinished goods from one Sub-contractor to the next.

This document specifies only the technology (when necessary) and the characteristics of the final product and of the initial goods (components) to be used in the manufacturing; it can also give directives that involve also n<sup>th</sup>-tier sub-subcontractors in order to be compliant with requirements like CITES or Country of Origin

The output product specified in each line item can be the input component in a following line item also in the same Commission order.

### 1.3. Possible scenario

Subcontracted fashion manufacturing

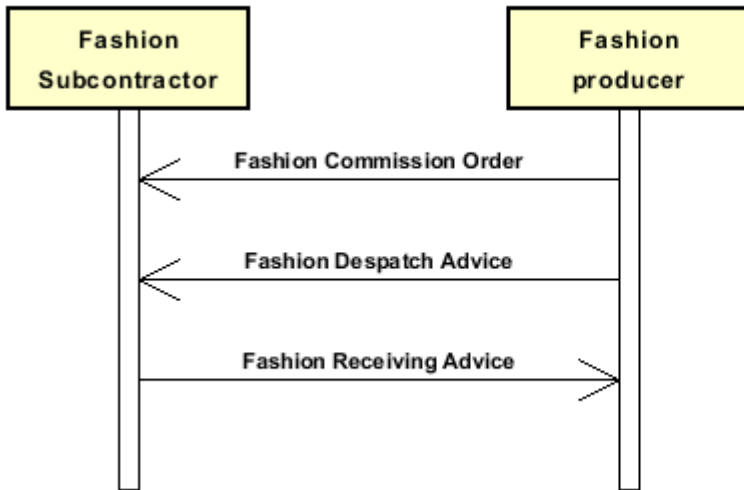

## 2. IMPLEMENTATION GUIDE

### 2.1 General structure of XML document

All the business data that can be exchanged through this class of documents are shown in the following "document structure", that provides a simplified vision of the Schema.

In particular:

- the two numbers following each element define its "cardinality" (minimum and maximum number of occurrences); the minimum equal zero indicates that the element is optional, the minimum greater than zero indicates that is mandatory;
- the bold character denotes the complex elements (aggregates of simple elements) that were built for the sake of functionality and re-usability of some complex informations sets. The child elements in each parent element are easily spotted as "indented";
- the symbol "@" denotes an attribute of the preceding element; here "the usage indicator (optional, required, ...)" is shown in square brackets.

### Structure

#### **KnitClothOrder**

*@msgfunction [Optional] [Default= OR]*

*@version [Optional] [Default= draft]*

*@useProfile [Optional]*

*@KCCOtype [Optional]*

| **KCCOheader 1-1**

| | msgN 1-1

| | - choose -

| | msgID 0-1

| | - or -

| | docID 0-1

| | *@numberingOrg [Optional]*

| | - end choose -

| | msgDate 1-1

| | *@dateForm [Optional]*

| | season 0-1

| | *@numberingOrg [Optional]*

| | *@codeList [Optional]*

| | *@listName [Optional]*

| | *@listVersion [Optional]*

| | msgCurrency 0-1

| | validityStart 0-1

| | *@dateForm [Optional]*

| | validityEnd 0-1

| | *@dateForm [Optional]*

| | **refDoc 0-9**

| | *@docType [Required]*

| | | docID 1-2

| | | *@numberingOrg [Optional]*

| | | docDate 0-1

| | | *@dateForm [Optional]*

| | | season 0-1

| | | *@numberingOrg [Optional]*

| | | *@codeList [Optional]*

| | | *@listName [Optional]*

| | | *@listVersion [Optional]*

| | | itemID 0-1

| | | **attachment 0-1**

| | | *@uid [Optional]*

| | | | fileName 0-1

| | | | *@numberingOrg [Optional]*

- | | | binaryObject 0-1
- | | | | @format [Optional]
- | | | | @mime [Optional]
- | | | | @encoding [Optional]
- | | | | @characterSet [Optional]
- | | | **externalReference 0-99**
- | | | | uri 1-1
- | | | | | @isURL [Optional] [Default= true]
- | | | | mimeTypeCode 0-1
- | | | | formatCode 0-1
- | | | | encodingCode 0-1
- | | | | characterSetCode 0-1

**buyer 1-1**

- | | @logo [Optional]
- | | @sender [Optional]
- | | id 1-1
- | | | @numberingOrg [Optional]
- | | additionalIdentifier 0-9
- | | | @numberingOrg [Optional]
- | | | @idQualifier [Optional]
- | | legalName 0-1
- | | dept 0-1
- | | subDept 0-1
- | | person 0-1
- | | | @email [Optional]
- | | | @phone [Optional]
- | | | @fax [Optional]
- | | street 0-1
- | | city 0-1
- | | subCountry 0-1
- | | country 0-1
- | | postCode 0-1

**subContractor 1-1**

- | | @sender [Optional]
- | | id 1-1
- | | | @numberingOrg [Optional]
- | | legalName 0-1
- | | dept 0-1
- | | subDept 0-1
- | | person 0-1
- | | | @email [Optional]
- | | | @phone [Optional]
- | | | @fax [Optional]
- | | street 0-1
- | | city 0-1
- | | subCountry 0-1
- | | country 0-1
- | | postCode 0-1

**thirdParty 0-5**

- | | @VAT [Optional]
- | | @role [Required]
- | | @sender [Optional]
- | | id 1-1
- | | | @numberingOrg [Optional]
- | | legalName 0-1
- | | dept 0-1
- | | subDept 0-1
- | | person 0-1
- | | | @email [Optional]
- | | | @phone [Optional]
- | | | @fax [Optional]

| | | street 0-1  
| | | city 0-1  
| | | subCountry 0-1  
| | | country 0-1  
| | | postCode 0-1  
| | note 0-99  
| | @numberingOrg [Optional]  
| | @codeList [Optional]  
| | @noteLabel [Optional]

| **terms 0-1**

| | **payment 0-5**  
| | @finDiscount [Optional]  
| | @finSurcharge [Optional]

| | - choose -

| | | payTerm 1-1

| | - or -

| | | payTermText 1-1

| | - end choose -

| | | payMode 0-1

| | **insPayment 0-5**

| | @part [Required]

| | - choose -

| | | payTerm 1-1

| | - or -

| | | payTermText 1-1

| | - end choose -

| | | payMode 0-1

| | **trade 0-1**

| | - choose -

| | | incoTermText 1-1

| | - or -

| | | incoTerm 1-1

| | - end choose -

| | | location 0-1

| | | @LRI [Optional]

| | **transInfo 0-5**

| | @transReason [Optional]

| | @progr [Optional]

| | | transMode 1-1

| | | carrier 0-1

| | | deliveryPlace 0-1

| | | grossWeight 0-1

| | | @um [Required]

| | | netWeight 0-1

| | | @um [Required]

| | | transMeans 0-1

| | | transCondition 0-3

| | | transConditionText 0-1

| | | despatchPlace 0-1

| | | despatchDate 0-1

| | | @dateForm [Optional]

| | | delEffectiveDate 0-1

| | | @dateForm [Optional]

| | **allowanceCharge 0-9**

| | @um [Optional]

| | @VAT [Optional]

| | @minQty [Optional]

| | @currency [Optional]

| | @maxQty [Optional]

| | - choose -

- | | | AC\_category 1-1
- | | | - or -
- | | | AC\_categoryText 1-1
- | | | - end choose -
- | | | - choose -
- | | | AC\_percent 1-1
- | | | - or -
- | | | AC\_amount 1-1
- | | | - end choose -
- | | | **dtScheme 0-1**
- | | | @taxType [Required]
- | | | | taxCategory 0-1
- | | | | taxRate 0-1
- | | | | legalRef 0-1
- | | | | @codeList [Required]
- | | | | note 0-99
- | | | | @numberingOrg [Optional]
- | | | | @codeList [Optional]
- | | | | @noteLabel [Optional]

| **garComInfo 0-1**

- | | @endUse [Optional]
- | | | season 0-1
- | | | @numberingOrg [Optional]
- | | | @codeList [Optional]
- | | | @listName [Optional]
- | | | @listVersion [Optional]
- | | | brand 0-1
- | | | @numberingOrg [Optional]
- | | | @codeList [Optional]
- | | | @listName [Optional]
- | | | @listVersion [Optional]
- | | | productLine 0-1
- | | | @numberingOrg [Optional]
- | | | @codeList [Optional]
- | | | @listName [Optional]
- | | | @listVersion [Optional]
- | | | project 0-1
- | | | operationalCode 0-19
- | | | @numberingOrg [Optional]
- | | | @codeList [Optional]
- | | | @listName [Optional]
- | | | @listVersion [Optional]
- | | | @codeQualifier [Optional]
- | | | deliveryDate 0-1
- | | | @dateForm [Optional]
- | | | specDate 0-1
- | | | @dateForm [Optional]
- | | | note 0-99
- | | | @numberingOrg [Optional]
- | | | @codeList [Optional]
- | | | @noteLabel [Optional]

| **KCCObody 1-1**

- | | **KCCOitem 1-unbounded**
- | | | @productLevel [Optional] [Default= END]
- | | | | lineN 1-1
- | | | | @VAT [Optional]
- | | | | lineID 0-1
- | | | | priority 0-1
- | | | **apparelProd 1-1**

- choose -

**garmentPartCode 1-2**

@numberingOrg [Optional]  
| gPart 1-1  
| mod 1-1  
| @numberingOrg [Optional]  
| @codeList [Optional]  
| @listName [Optional]  
| @listVersion [Optional]  
| fabric 0-1  
| @numberingOrg [Optional]  
| @codeList [Optional]  
| @listName [Optional]  
| @listVersion [Optional]  
| color 0-1  
| @numberingOrg [Optional]  
| @codeList [Optional]  
| @listName [Optional]  
| @listVersion [Optional]  
| added 0-19  
| @numberingOrg [Optional]  
| @addType [Optional]  
| size 0-1  
| @codeList [Optional]  
| description 0-unbounded  
| @ln [Optional]

- or -

**garmentCode 1-2**

@numberingOrg [Optional]

- choose -

**garmentCodeB 1-1**

@numberingOrg [Optional]  
| mod 1-1  
| @numberingOrg [Optional]  
| @codeList [Optional]  
| @listName [Optional]  
| @listVersion [Optional]  
| fabric 0-1  
| @numberingOrg [Optional]  
| @codeList [Optional]  
| @listName [Optional]  
| @listVersion [Optional]  
| color 0-1  
| @numberingOrg [Optional]  
| @codeList [Optional]  
| @listName [Optional]  
| @listVersion [Optional]

**garmentVariant 0-9**

| variantType 1-1  
| @numberingOrg [Optional]  
| @codeList [Optional]  
| @listName [Optional]  
| @listVersion [Optional]  
| variantCode 1-1  
| @numberingOrg [Optional]  
| @codeList [Optional]  
| @listName [Optional]  
| @listVersion [Optional]

drop 0-1  
| @codeList [Optional]  
size 0-1



```

| | | | | @codeList [Optional]
| | | | | artGroup 0-1
| | | | | @numberingOrg [Optional]
| | | | | @codeList [Optional]
| | | | | @listName [Optional]
| | | | | @listVersion [Optional]
| | | | | added 0-9
| | | | | @numberingOrg [Optional]
| | | | | @addType [Optional]
| | | | | description 0-unbounded
| | | | | @ln [Optional]
| | | | | - or -
| | | | | garmentCodeA 1-1
| | | | | | art 1-1
| | | | | | @numberingOrg [Optional]
| | | | | | @codeList [Optional]
| | | | | | @listName [Optional]
| | | | | | @listVersion [Optional]
| | | | | | description 0-unbounded
| | | | | | @ln [Optional]
| | | | | - end choose -
| | | | | - end choose -
| | | | | lotN 0-1
| | | | | | @numberingOrg [Optional]
| | | | | dyeN 0-1
| | | | | | @numberingOrg [Optional]
| | | | | qty 1-2
| | | | | | @um [Required]
| | | | | csRange 0-99
| | | | | | @numberingOrg [Optional]
| | | | | | @sizeSystemNat [Optional]
| | | | | | @sizeSystemSeg [Optional]
| | | | | | @sizeSystemBase [Optional]
| | | | | | @sizeSystemID [Optional]
| | | | | | color 0-1
| | | | | | | @numberingOrg [Optional]
| | | | | | | @codeList [Optional]
| | | | | | | @listName [Optional]
| | | | | | | @listVersion [Optional]
| | | | | | garmentVariant 0-9
| | | | | | | variantType 1-1
| | | | | | | | @numberingOrg [Optional]
| | | | | | | | @codeList [Optional]
| | | | | | | | @listName [Optional]
| | | | | | | | @listVersion [Optional]
| | | | | | | variantCode 1-1
| | | | | | | | @numberingOrg [Optional]
| | | | | | | | @codeList [Optional]
| | | | | | | | @listName [Optional]
| | | | | | | | @listVersion [Optional]
| | | | | | drop 0-1
| | | | | | | @codeList [Optional]
| | | | | | sizeMatrix 1-1
| | | | | | | sizeRow 1-99
| | | | | | | | additionalComponentCode 0-9
| | | | | | | | | @numberingOrg [Optional]
| | | | | | | | | @codeList [Optional]
| | | | | | | | | @listName [Optional]
| | | | | | | | | @listVersion [Optional]
| | | | | | | | drop 0-1
| | | | | | | | | @codeList [Optional]

```

```

| | | | | size 1-1
| | | | |   @codeList [Optional]
| | | | | qty 0-1
| | | | |   @um [Required]
| | | | | itemsList 0-1
| | | | |   qualityLevel 0-1
| | | | |   @numberingOrg [Optional]
| | | | |   @codeList [Optional]
| | | | |   @listName [Optional]
| | | | |   @listVersion [Optional]
| | | | |   itemIdentification 1-unbounded
| | | | |     serialN 1-9
| | | | |     @numberingOrg [Optional]
| | | | |     @idQualifier [Optional]
| | | | | note 0-99
| | | | |   @numberingOrg [Optional]
| | | | |   @codeList [Optional]
| | | | |   @noteLabel [Optional]
| | | | | price 0-1
| | | | |   @um [Optional]
| | | | |   @priceQualifier [Optional] [Default= NET]
| | | | |   @currency [Optional]
| | | | | deliveryDate 0-1
| | | | |   @dateForm [Optional]
| | | | | thirdParty 0-5
| | | | |   @VAT [Optional]
| | | | |   @role [Required]
| | | | |   @sender [Optional]
| | | | |     id 1-1
| | | | |     @numberingOrg [Optional]
| | | | |     legalName 0-1
| | | | |     dept 0-1
| | | | |     subDept 0-1
| | | | |     person 0-1
| | | | |     @email [Optional]
| | | | |     @phone [Optional]
| | | | |     @fax [Optional]
| | | | |     street 0-1
| | | | |     city 0-1
| | | | |     subCountry 0-1
| | | | |     country 0-1
| | | | |     postCode 0-1
| | | | | garTecSheet 0-1
| | | | |   garmentCode 1-2
| | | | |   @numberingOrg [Optional]
| | | | |   - choose -
| | | | |   garmentCodeB 1-1
| | | | |   @numberingOrg [Optional]
| | | | |     mod 1-1
| | | | |     @numberingOrg [Optional]
| | | | |     @codeList [Optional]
| | | | |     @listName [Optional]
| | | | |     @listVersion [Optional]
| | | | |     fabric 0-1
| | | | |     @numberingOrg [Optional]
| | | | |     @codeList [Optional]
| | | | |     @listName [Optional]
| | | | |     @listVersion [Optional]
| | | | |     color 0-1
| | | | |     @numberingOrg [Optional]
| | | | |     @codeList [Optional]

```

```

| | | | @listName [Optional]
| | | | @listVersion [Optional]
| | | | garmentVariant 0-9
| | | | | variantType 1-1
| | | | | | @numberingOrg [Optional]
| | | | | | @codeList [Optional]
| | | | | | @listName [Optional]
| | | | | | @listVersion [Optional]
| | | | | variantCode 1-1
| | | | | | @numberingOrg [Optional]
| | | | | | @codeList [Optional]
| | | | | | @listName [Optional]
| | | | | | @listVersion [Optional]
| | | | drop 0-1
| | | | | @codeList [Optional]
| | | | size 0-1
| | | | | @codeList [Optional]
| | | | artGroup 0-1
| | | | | @numberingOrg [Optional]
| | | | | @codeList [Optional]
| | | | | @listName [Optional]
| | | | | @listVersion [Optional]
| | | | added 0-9
| | | | | @numberingOrg [Optional]
| | | | | @addType [Optional]
| | | | description 0-unbounded
| | | | | @ln [Optional]

```

- or -

```

| | | | garmentCodeA 1-1
| | | | | art 1-1
| | | | | | @numberingOrg [Optional]
| | | | | | @codeList [Optional]
| | | | | | @listName [Optional]
| | | | | | @listVersion [Optional]
| | | | | description 0-unbounded
| | | | | @ln [Optional]

```

- end choose -

**refDoc 0-9**

```

| | | | @docType [Required]
| | | | | docID 1-2
| | | | | | @numberingOrg [Optional]
| | | | | docDate 0-1
| | | | | | @dateForm [Optional]
| | | | | season 0-1
| | | | | | @numberingOrg [Optional]
| | | | | | @codeList [Optional]
| | | | | | @listName [Optional]
| | | | | | @listVersion [Optional]
| | | | | itemID 0-1
| | | | | attachment 0-1
| | | | | | @uid [Optional]
| | | | | | | fileName 0-1
| | | | | | | | @numberingOrg [Optional]
| | | | | | | binaryObject 0-1
| | | | | | | | @format [Optional]
| | | | | | | | @mime [Optional]
| | | | | | | | @encoding [Optional]
| | | | | | | | @characterSet [Optional]
| | | | | | externalReference 0-99
| | | | | | | uri 1-1
| | | | | | | | @isURL [Optional] [Default= true]

```

| mimeCode 0-1  
 | formatCode 0-1  
 | encodingCode 0-1  
 | characterSetCode 0-1

**fabricCompos 0-1**

| percCompos 1-9  
 | @fibre [Required]

customsStat 0-1

grossWeight 0-1

@um [Required]

netWeight 0-1

@um [Required]

**garSizeSet 0-1**

@numberingOrg [Optional]

| **garSizeTier 1-9**

| garSizeCode 1-1

| sizeStart 1-1

| sizeEnd 0-1

**garMeaSet 0-99**

| garAttrib 1-1

| **garMea 1-9**

| size 0-1

| @codeList [Optional]

| specValue 1-1

| @um [Optional]

| @source [Optional]

| @method [Optional]

| @application [Optional]

| @CV [Optional]

**garConsumptionSet 0-99**

- choose -

| **acsCode 1-1**

| @numberingOrg [Optional]

| art 1-1

| @numberingOrg [Optional]

| @codeList [Optional]

| @listName [Optional]

| @listVersion [Optional]

| pattern 0-1

| @numberingOrg [Optional]

| @codeList [Optional]

| @listName [Optional]

| @listVersion [Optional]

| color 0-1

| @numberingOrg [Optional]

| @codeList [Optional]

| @listName [Optional]

| @listVersion [Optional]

| added 0-9

| @numberingOrg [Optional]

| @addType [Optional]

| description 0-unbounded

| @ln [Optional]

- or -

| **texCode 1-1**

| @numberingOrg [Optional]

| art 1-1

| @numberingOrg [Optional]

| @codeList [Optional]

| @listName [Optional]

| @listVersion [Optional]

| pattern 0-1  
 | @numberingOrg [Optional]  
 | @codeList [Optional]  
 | @listName [Optional]  
 | @listVersion [Optional]  
 | color 0-1  
 | @numberingOrg [Optional]  
 | @codeList [Optional]  
 | @listName [Optional]  
 | @listVersion [Optional]  
 | added 0-9  
 | @numberingOrg [Optional]  
 | @addType [Optional]  
 | description 0-unbounded  
 | @ln [Optional]

- or -

| **yarnCode 1-1**  
 | @numberingOrg [Optional] [Default= CL]  
 | art 1-1  
 | @numberingOrg [Optional]  
 | @codeList [Optional]  
 | @listName [Optional]  
 | @listVersion [Optional]  
 | color 0-1  
 | @numberingOrg [Optional]  
 | @codeList [Optional]  
 | @listName [Optional]  
 | @listVersion [Optional]  
 | added 0-9  
 | @numberingOrg [Optional]  
 | @addType [Optional]  
 | description 0-unbounded  
 | @ln [Optional]

- or -

| **garmentPartCode 1-1**  
 | @numberingOrg [Optional]  
 | gPart 1-1  
 | mod 1-1  
 | @numberingOrg [Optional]  
 | @codeList [Optional]  
 | @listName [Optional]  
 | @listVersion [Optional]  
 | fabric 0-1  
 | @numberingOrg [Optional]  
 | @codeList [Optional]  
 | @listName [Optional]  
 | @listVersion [Optional]  
 | color 0-1  
 | @numberingOrg [Optional]  
 | @codeList [Optional]  
 | @listName [Optional]  
 | @listVersion [Optional]  
 | added 0-19  
 | @numberingOrg [Optional]  
 | @addType [Optional]  
 | size 0-1  
 | @codeList [Optional]  
 | description 0-unbounded  
 | @ln [Optional]

- or -

| **garmentCode 1-1**

```

| | | | | @numberingOrg [Optional]
- choose -
| | | | | garmentCodeB 1-1
| | | | | @numberingOrg [Optional]
| | | | | mod 1-1
| | | | | @numberingOrg [Optional]
| | | | | @codeList [Optional]
| | | | | @listName [Optional]
| | | | | @listVersion [Optional]
| | | | | fabric 0-1
| | | | | @numberingOrg [Optional]
| | | | | @codeList [Optional]
| | | | | @listName [Optional]
| | | | | @listVersion [Optional]
| | | | | color 0-1
| | | | | @numberingOrg [Optional]
| | | | | @codeList [Optional]
| | | | | @listName [Optional]
| | | | | @listVersion [Optional]
| | | | | garmentVariant 0-9
| | | | | variantType 1-1
| | | | | @numberingOrg [Optional]
| | | | | @codeList [Optional]
| | | | | @listName [Optional]
| | | | | @listVersion [Optional]
| | | | | variantCode 1-1
| | | | | @numberingOrg [Optional]
| | | | | @codeList [Optional]
| | | | | @listName [Optional]
| | | | | @listVersion [Optional]
| | | | | drop 0-1
| | | | | @codeList [Optional]
| | | | | size 0-1
| | | | | @codeList [Optional]
| | | | | artGroup 0-1
| | | | | @numberingOrg [Optional]
| | | | | @codeList [Optional]
| | | | | @listName [Optional]
| | | | | @listVersion [Optional]
| | | | | added 0-9
| | | | | @numberingOrg [Optional]
| | | | | @addType [Optional]
| | | | | description 0-unbounded
| | | | | @ln [Optional]
- or -
| | | | | garmentCodeA 1-1
| | | | | art 1-1
| | | | | @numberingOrg [Optional]
| | | | | @codeList [Optional]
| | | | | @listName [Optional]
| | | | | @listVersion [Optional]
| | | | | description 0-unbounded
| | | | | @ln [Optional]
- end choose -
- end choose -
| | | | | lotN 0-99
| | | | | @numberingOrg [Optional]
| | | | | dyeN 0-99
| | | | | @numberingOrg [Optional]
| | | | | garConsumption 1-9
| | | | | @numberingOrg [Optional]

```

```

| | | | | @consumptionType [Optional]
| | | | |   garSizeCode 0-1
| | | | |   qty 1-1
| | | | |   @um [Required]
| | | | |   qtyVariance 0-1
| | | | |   @um [Optional]
| | | | |   @varReason [Optional]
| | | | | mnfrNote 0-99
| | | | | @subject [Optional]
| | | | | image 0-99
| | | | | @subject [Optional]
| | | | | progress 0-9
| | | | |   qty 1-2
| | | | |   @um [Required]
| | | | |   deliveryDate 0-1
| | | | |   @dateForm [Optional]
| | | | |   delGrantedDate 0-1
| | | | |   @dateForm [Optional]
| | | | | - choose -
| | | | |   mfrStatus 0-1
| | | | | - or -
| | | | |   mfrStatusText 0-1
| | | | | - end choose -
| | | | | itemsList 0-1
| | | | |   qualityLevel 0-1
| | | | |   @numberingOrg [Optional]
| | | | |   @codeList [Optional]
| | | | |   @listName [Optional]
| | | | |   @listVersion [Optional]
| | | | |   itemIdentification 1-unbounded
| | | | |     serialN 1-9
| | | | |     @numberingOrg [Optional]
| | | | |     @idQualifier [Optional]
| | | | | apparelComponent 0-9
| | | | |   gPart 0-1
| | | | |   yarnComponent 0-9
| | | | |     @CQQ [Optional]
| | | | |     pcQty 0-1
| | | | |     @um [Optional]
| | | | |     yarnCode 1-1
| | | | |       @numberingOrg [Optional] [Default= CL]
| | | | |       art 1-1
| | | | |       @numberingOrg [Optional]
| | | | |       @codeList [Optional]
| | | | |       @listName [Optional]
| | | | |       @listVersion [Optional]
| | | | |       color 0-1
| | | | |       @numberingOrg [Optional]
| | | | |       @codeList [Optional]
| | | | |       @listName [Optional]
| | | | |       @listVersion [Optional]
| | | | |       added 0-9
| | | | |       @numberingOrg [Optional]
| | | | |       @addType [Optional]
| | | | |       description 0-unbounded
| | | | |       @ln [Optional]
| | | | |   lotN 0-1
| | | | |   @numberingOrg [Optional]
| | | | |   dyeN 0-1
| | | | |   @numberingOrg [Optional]
| | | | |   qty 1-2

```

```

| @um [Required]
| refDoc 0-1
| @docType [Required]
|   docID 1-2
|   | @numberingOrg [Optional]
|   docDate 0-1
|   | @dateForm [Optional]
|   season 0-1
|   | @numberingOrg [Optional]
|   | @codeList [Optional]
|   | @listName [Optional]
|   | @listVersion [Optional]
|   itemID 0-1
|   attachment 0-1
|   | @uid [Optional]
|   |   fileName 0-1
|   |   | @numberingOrg [Optional]
|   |   binaryObject 0-1
|   |   | @format [Optional]
|   |   | @mime [Optional]
|   |   | @encoding [Optional]
|   |   | @characterSet [Optional]
|   |   externalReference 0-99
|   |   | uri 1-1
|   |   | | @isURL [Optional] [Default= true]
|   |   | mimeCode 0-1
|   |   | formatCode 0-1
|   |   | encodingCode 0-1
|   |   | characterSetCode 0-1
| location 0-1
| | @LRI [Optional]
| warpLetter 0-1
| weftLetter 0-1
| note 0-99
| | @numberingOrg [Optional]
| | @codeList [Optional]
| | @noteLabel [Optional]
| fabricComponent 0-9
| | texCode 1-1
| | | @numberingOrg [Optional]
| | |   art 1-1
| | |   | @numberingOrg [Optional]
| | |   | @codeList [Optional]
| | |   | @listName [Optional]
| | |   | @listVersion [Optional]
| | | pattern 0-1
| | | | @numberingOrg [Optional]
| | | | @codeList [Optional]
| | | | @listName [Optional]
| | | | @listVersion [Optional]
| | | color 0-1
| | | | @numberingOrg [Optional]
| | | | @codeList [Optional]
| | | | @listName [Optional]
| | | | @listVersion [Optional]
| | | added 0-9
| | | | @numberingOrg [Optional]
| | | | @addType [Optional]
| | | description 0-unbounded
| | | | @ln [Optional]
| qty 1-3

```



```

| | | | @um [Required]
- choose -
| | | | serialN 0-unbounded
| | | | @numberingOrg [Optional]
| | | | @idQualifier [Optional]
- or -
| | | | itemsList 0-unbounded
| | | | | qualityLevel 0-1
| | | | | @numberingOrg [Optional]
| | | | | @codeList [Optional]
| | | | | @listName [Optional]
| | | | | @listVersion [Optional]
| | | | | itemIdentification 1-unbounded
| | | | | | serialN 1-9
| | | | | | @numberingOrg [Optional]
| | | | | | @idQualifier [Optional]
- end choose -
| | | | refDoc 0-1
| | | | | @docType [Required]
| | | | | docID 1-2
| | | | | | @numberingOrg [Optional]
| | | | | docDate 0-1
| | | | | | @dateForm [Optional]
| | | | | season 0-1
| | | | | | @numberingOrg [Optional]
| | | | | | @codeList [Optional]
| | | | | | @listName [Optional]
| | | | | | @listVersion [Optional]
| | | | | itemID 0-1
| | | | | attachment 0-1
| | | | | | @uid [Optional]
| | | | | | | fileName 0-1
| | | | | | | | @numberingOrg [Optional]
| | | | | | | binaryObject 0-1
| | | | | | | | @format [Optional]
| | | | | | | | @mime [Optional]
| | | | | | | | @encoding [Optional]
| | | | | | | | @characterSet [Optional]
| | | | | | externalReference 0-99
| | | | | | | uri 1-1
| | | | | | | | @isURL [Optional] [Default= true]
| | | | | | | | mimeTypeCode 0-1
| | | | | | | | formatCode 0-1
| | | | | | | | encodingCode 0-1
| | | | | | | | characterSetCode 0-1
| | | | | location 0-1
| | | | | | @LRI [Optional]
| | | | | note 0-99
| | | | | | @numberingOrg [Optional]
| | | | | | @codeList [Optional]
| | | | | | @noteLabel [Optional]
| | | | garmentPartComponent 0-9
| | | | | garmentPartCode 1-1
| | | | | | @numberingOrg [Optional]
| | | | | | | gPart 1-1
| | | | | | | mod 1-1
| | | | | | | | @numberingOrg [Optional]
| | | | | | | | @codeList [Optional]
| | | | | | | | @listName [Optional]
| | | | | | | | @listVersion [Optional]
| | | | | | fabric 0-1

```

```

| | | | @numberingOrg [Optional]
| | | | @codeList [Optional]
| | | | @listName [Optional]
| | | | @listVersion [Optional]
| | | | color 0-1
| | | | @numberingOrg [Optional]
| | | | @codeList [Optional]
| | | | @listName [Optional]
| | | | @listVersion [Optional]
| | | | added 0-19
| | | | @numberingOrg [Optional]
| | | | @addType [Optional]
| | | | size 0-1
| | | | @codeList [Optional]
| | | | description 0-unbounded
| | | | @ln [Optional]
| | | | lotN 0-1
| | | | @numberingOrg [Optional]
| | | | dyeN 0-1
| | | | @numberingOrg [Optional]
| | | | qty 1-2
| | | | @um [Required]
| | | | refDoc 0-1
| | | | @docType [Required]
| | | | | docID 1-2
| | | | | @numberingOrg [Optional]
| | | | | docDate 0-1
| | | | | @dateForm [Optional]
| | | | | season 0-1
| | | | | @numberingOrg [Optional]
| | | | | @codeList [Optional]
| | | | | @listName [Optional]
| | | | | @listVersion [Optional]
| | | | | itemID 0-1
| | | | | attachment 0-1
| | | | | @uid [Optional]
| | | | | | fileName 0-1
| | | | | | @numberingOrg [Optional]
| | | | | | binaryObject 0-1
| | | | | | @format [Optional]
| | | | | | @mime [Optional]
| | | | | | @encoding [Optional]
| | | | | | @characterSet [Optional]
| | | | | | externalReference 0-99
| | | | | | | uri 1-1
| | | | | | | @isURL [Optional] [Default= true]
| | | | | | | mimeTypeCode 0-1
| | | | | | | formatCode 0-1
| | | | | | | encodingCode 0-1
| | | | | | | characterSetCode 0-1
| | | | | location 0-1
| | | | | @LRI [Optional]
| | | | | note 0-99
| | | | | @numberingOrg [Optional]
| | | | | @codeList [Optional]
| | | | | @noteLabel [Optional]
| | | | | acsComponent 0-99
| | | | | | acsCode 1-1
| | | | | | @numberingOrg [Optional]
| | | | | | | art 1-1
| | | | | | | @numberingOrg [Optional]

```

```

| | | | | @codeList [Optional]
| | | | | @listName [Optional]
| | | | | @listVersion [Optional]
| | | | | pattern 0-1
| | | | | @numberingOrg [Optional]
| | | | | @codeList [Optional]
| | | | | @listName [Optional]
| | | | | @listVersion [Optional]
| | | | | color 0-1
| | | | | @numberingOrg [Optional]
| | | | | @codeList [Optional]
| | | | | @listName [Optional]
| | | | | @listVersion [Optional]
| | | | | added 0-9
| | | | | @numberingOrg [Optional]
| | | | | @addType [Optional]
| | | | | description 0-unbounded
| | | | | @ln [Optional]
| | | | | lotN 0-1
| | | | | @numberingOrg [Optional]
| | | | | dyeN 0-1
| | | | | @numberingOrg [Optional]
| | | | | qty 1-2
| | | | | @um [Required]
| | | | | refDoc 0-1
| | | | | @docType [Required]
| | | | | docID 1-2
| | | | | @numberingOrg [Optional]
| | | | | docDate 0-1
| | | | | @dateForm [Optional]
| | | | | season 0-1
| | | | | @numberingOrg [Optional]
| | | | | @codeList [Optional]
| | | | | @listName [Optional]
| | | | | @listVersion [Optional]
| | | | | itemID 0-1
| | | | | attachment 0-1
| | | | | @uid [Optional]
| | | | | | fileName 0-1
| | | | | | @numberingOrg [Optional]
| | | | | | binaryObject 0-1
| | | | | | @format [Optional]
| | | | | | @mime [Optional]
| | | | | | @encoding [Optional]
| | | | | | @characterSet [Optional]
| | | | | | externalReference 0-99
| | | | | | | uri 1-1
| | | | | | | @isURL [Optional] [Default= true]
| | | | | | | mimeTypeCode 0-1
| | | | | | | formatCode 0-1
| | | | | | | encodingCode 0-1
| | | | | | | characterSetCode 0-1
| | | | | location 0-1
| | | | | @LRI [Optional]
| | | | | note 0-99
| | | | | @numberingOrg [Optional]
| | | | | @codeList [Optional]
| | | | | @noteLabel [Optional]
| | | | | appMnfrOperation 0-9
| | | | | - choose -
| | | | | | jobName 1-1

```

```

- or -
| | | appJob 1-1
- end choose -
| | | appJobTech 0-1
| | | refDoc 0-1
| | |   @docType [Required]
| | |     docID 1-2
| | |       @numberingOrg [Optional]
| | |     docDate 0-1
| | |       @dateForm [Optional]
| | |     season 0-1
| | |       @numberingOrg [Optional]
| | |       @codeList [Optional]
| | |       @listName [Optional]
| | |       @listVersion [Optional]
| | |     itemID 0-1
| | |   attachment 0-1
| | |     @uid [Optional]
| | |       fileName 0-1
| | |         @numberingOrg [Optional]
| | |       binaryObject 0-1
| | |         @format [Optional]
| | |         @mime [Optional]
| | |         @encoding [Optional]
| | |         @characterSet [Optional]
| | |     externalReference 0-99
| | |       uri 1-1
| | |         @isURL [Optional] [Default= true]
| | |       mimeTypeCode 0-1
| | |       formatCode 0-1
| | |       encodingCode 0-1
| | |       characterSetCode 0-1
| | | appMachine 0-1
| | | note 0-99
| | |   @numberingOrg [Optional]
| | |   @codeList [Optional]
| | |   @noteLabel [Optional]
| | | phase 0-99
| | | @progr [Required]
| | | phaseCode 1-1
| | |   @numberingOrg [Optional]
| | |   @codeList [Optional]
| | |   @listName [Optional]
| | |   @listVersion [Optional]
| | | criticalityIndicator 0-1
| | | finalIndicator 0-1
| | | qty 0-2
| | |   @um [Required]
| | | lotDetails 0-99
| | |   lotN 1-1
| | |     @numberingOrg [Optional]
| | |   qty 0-1
| | |     @um [Required]
| | |   csRange 0-99
| | |     @numberingOrg [Optional]
| | |     @sizeSystemNat [Optional]
| | |     @sizeSystemSeg [Optional]
| | |     @sizeSystemBase [Optional]
| | |     @sizeSystemID [Optional]
| | |     color 0-1
| | |     @numberingOrg [Optional]

```

```

| @codeList [Optional]
| @listName [Optional]
| @listVersion [Optional]
| garmentVariant 0-9
|   variantType 1-1
|   | @numberingOrg [Optional]
|   | @codeList [Optional]
|   | @listName [Optional]
|   | @listVersion [Optional]
|   variantCode 1-1
|   | @numberingOrg [Optional]
|   | @codeList [Optional]
|   | @listName [Optional]
|   | @listVersion [Optional]
| drop 0-1
| @codeList [Optional]
| sizeMatrix 1-1
|   sizeRow 1-99
|   | additionalComponentCode 0-9
|   | | @numberingOrg [Optional]
|   | | @codeList [Optional]
|   | | @listName [Optional]
|   | | @listVersion [Optional]
|   | drop 0-1
|   | | @codeList [Optional]
|   | size 1-1
|   | | @codeList [Optional]
|   | qty 0-1
|   | | @um [Required]
|   | itemsList 0-1
|   | | qualityLevel 0-1
|   | | | @numberingOrg [Optional]
|   | | | @codeList [Optional]
|   | | | @listName [Optional]
|   | | | @listVersion [Optional]
|   | | itemIdentification 1-unbounded
|   | | | serialN 1-9
|   | | | @numberingOrg [Optional]
|   | | | @idQualifier [Optional]
| refDoc 0-99
| @docType [Required]
| | docID 1-2
| | | @numberingOrg [Optional]
| | docDate 0-1
| | | @dateForm [Optional]
| | season 0-1
| | | @numberingOrg [Optional]
| | | @codeList [Optional]
| | | @listName [Optional]
| | | @listVersion [Optional]
| | itemID 0-1
| attachment 0-1
| @uid [Optional]
| | fileName 0-1
| | | @numberingOrg [Optional]
| | binaryObject 0-1
| | | @format [Optional]
| | | @mime [Optional]
| | | @encoding [Optional]
| | | @characterSet [Optional]
| externalReference 0-99

```

| | | | | uri 1-1  
| | | | | @isURL [Optional] [Default= true]  
| | | | | mimeTypeCode 0-1  
| | | | | formatCode 0-1  
| | | | | encodingCode 0-1  
| | | | | characterSetCode 0-1

notBeforeDate 0-1  
@dateForm [Optional]  
deliveryDate 0-1  
@dateForm [Optional]  
delGrantedDate 0-1  
@dateForm [Optional]  
price 0-1  
@um [Optional]  
@priceQualifier [Optional] [Default= NET]  
@currency [Optional]

**thirdParty 0-9**

@VAT [Optional]  
@role [Required]  
@sender [Optional]  
| id 1-1  
| @numberingOrg [Optional]  
| legalName 0-1  
| dept 0-1  
| subDept 0-1  
| person 0-1  
| @email [Optional]  
| @phone [Optional]  
| @fax [Optional]  
| street 0-1  
| city 0-1  
| subCountry 0-1  
| country 0-1  
| postCode 0-1

**garConsumptionSet 0-99**

- choose -

**acsCode 1-1**

@numberingOrg [Optional]  
| art 1-1  
| @numberingOrg [Optional]  
| @codeList [Optional]  
| @listName [Optional]  
| @listVersion [Optional]  
| pattern 0-1  
| @numberingOrg [Optional]  
| @codeList [Optional]  
| @listName [Optional]  
| @listVersion [Optional]  
| color 0-1  
| @numberingOrg [Optional]  
| @codeList [Optional]  
| @listName [Optional]  
| @listVersion [Optional]  
| added 0-9  
| @numberingOrg [Optional]  
| @addType [Optional]  
| description 0-unbounded  
| @ln [Optional]

- or -

**texCode 1-1**

@numberingOrg [Optional]

```

| | | | | art 1-1
| | | | |   @numberingOrg [Optional]
| | | | |   @codeList [Optional]
| | | | |   @listName [Optional]
| | | | |   @listVersion [Optional]
| | | | | pattern 0-1
| | | | |   @numberingOrg [Optional]
| | | | |   @codeList [Optional]
| | | | |   @listName [Optional]
| | | | |   @listVersion [Optional]
| | | | | color 0-1
| | | | |   @numberingOrg [Optional]
| | | | |   @codeList [Optional]
| | | | |   @listName [Optional]
| | | | |   @listVersion [Optional]
| | | | | added 0-9
| | | | |   @numberingOrg [Optional]
| | | | |   @addType [Optional]
| | | | | description 0-unbounded
| | | | | @ln [Optional]

```

- or -

```

| | | | | yarnCode 1-1
| | | | | @numberingOrg [Optional] [Default= CL]
| | | | |   art 1-1
| | | | |     @numberingOrg [Optional]
| | | | |     @codeList [Optional]
| | | | |     @listName [Optional]
| | | | |     @listVersion [Optional]
| | | | |   color 0-1
| | | | |     @numberingOrg [Optional]
| | | | |     @codeList [Optional]
| | | | |     @listName [Optional]
| | | | |     @listVersion [Optional]
| | | | |   added 0-9
| | | | |     @numberingOrg [Optional]
| | | | |     @addType [Optional]
| | | | |   description 0-unbounded
| | | | |   @ln [Optional]

```

- or -

```

| | | | | garmentPartCode 1-1
| | | | | @numberingOrg [Optional]
| | | | |   gPart 1-1
| | | | |   mod 1-1
| | | | |     @numberingOrg [Optional]
| | | | |     @codeList [Optional]
| | | | |     @listName [Optional]
| | | | |     @listVersion [Optional]
| | | | |   fabric 0-1
| | | | |     @numberingOrg [Optional]
| | | | |     @codeList [Optional]
| | | | |     @listName [Optional]
| | | | |     @listVersion [Optional]
| | | | |   color 0-1
| | | | |     @numberingOrg [Optional]
| | | | |     @codeList [Optional]
| | | | |     @listName [Optional]
| | | | |     @listVersion [Optional]
| | | | |   added 0-19
| | | | |     @numberingOrg [Optional]
| | | | |     @addType [Optional]
| | | | |   size 0-1

```

```

| | | | | @codeList [Optional]
| | | | | description 0-unbounded
| | | | | @ln [Optional]
- or -
| | | | | garmentCode 1-1
| | | | | @numberingOrg [Optional]
- choose -
| | | | | garmentCodeB 1-1
| | | | | @numberingOrg [Optional]
| | | | | mod 1-1
| | | | | @numberingOrg [Optional]
| | | | | @codeList [Optional]
| | | | | @listName [Optional]
| | | | | @listVersion [Optional]
| | | | | fabric 0-1
| | | | | @numberingOrg [Optional]
| | | | | @codeList [Optional]
| | | | | @listName [Optional]
| | | | | @listVersion [Optional]
| | | | | color 0-1
| | | | | @numberingOrg [Optional]
| | | | | @codeList [Optional]
| | | | | @listName [Optional]
| | | | | @listVersion [Optional]
| | | | | garmentVariant 0-9
| | | | | variantType 1-1
| | | | | @numberingOrg [Optional]
| | | | | @codeList [Optional]
| | | | | @listName [Optional]
| | | | | @listVersion [Optional]
| | | | | variantCode 1-1
| | | | | @numberingOrg [Optional]
| | | | | @codeList [Optional]
| | | | | @listName [Optional]
| | | | | @listVersion [Optional]
| | | | | drop 0-1
| | | | | @codeList [Optional]
| | | | | size 0-1
| | | | | @codeList [Optional]
| | | | | artGroup 0-1
| | | | | @numberingOrg [Optional]
| | | | | @codeList [Optional]
| | | | | @listName [Optional]
| | | | | @listVersion [Optional]
| | | | | added 0-9
| | | | | @numberingOrg [Optional]
| | | | | @addType [Optional]
| | | | | description 0-unbounded
| | | | | @ln [Optional]
- or -
| | | | | garmentCodeA 1-1
| | | | | art 1-1
| | | | | @numberingOrg [Optional]
| | | | | @codeList [Optional]
| | | | | @listName [Optional]
| | | | | @listVersion [Optional]
| | | | | description 0-unbounded
| | | | | @ln [Optional]
- end choose -
- end choose -
| | | | | lotN 0-99

```



```

| | | | | @numberingOrg [Optional]
| | | | | dyeN 0-99
| | | | | @numberingOrg [Optional]
| | | | | garConsumption 1-9
| | | | | @numberingOrg [Optional]
| | | | | @consumptionType [Optional]
| | | | | | garSizeCode 0-1
| | | | | | qty 1-1
| | | | | | @um [Required]
| | | | | | qtyVariance 0-1
| | | | | | @um [Optional]
| | | | | | @varReason [Optional]
| | | | | packages 0-99
| | | | | @packageLevel [Optional]
| | | | | - choose -
| | | | | | packageText 1-1
| | | | | - or -
| | | | | | package 1-1
| | | | | - end choose -
| | | | | | packageModelCode 0-1
| | | | | | @numberingOrg [Optional]
| | | | | | description 0-unbounded
| | | | | | @In [Optional]
| | | | | | packageDim 0-1
| | | | | | | length 1-1
| | | | | | | @um [Required]
| | | | | | | width 0-1
| | | | | | | @um [Required]
| | | | | | | height 0-1
| | | | | | | @um [Required]
| | | | | | handlingChar 0-1
| | | | | - choose -
| | | | | | yarnPack 0-1
| | | | | | | yarnReel 1-1
| | | | | | | @reelType [Required]
| | | | | | | @reelMat [Optional]
| | | | | | | | yarnReelID 0-1
| | | | | | | | @um [Required]
| | | | | | | | yarnReelH 0-1
| | | | | | | | @um [Required]
| | | | | | | | yarnConeAngle 0-1
| | | | | | | | yarnReelQty 0-2
| | | | | | | | @um [Required]
| | | | | | | | label 0-1
| | | | | | | | labelWrit 0-1
| | | | | | | yarnInWrap 0-1
| | | | | | | | yarnReelWrap 1-1
| | | | | | | | label 0-1
| | | | | | | | labelWrit 0-1
| | | | | | - choose -
| | | | | | | yarnOutWrapText 0-1
| | | | | | - or -
| | | | | | | yarnOutWrap 0-1
| | | | | | - end choose -
| | | | | - or -
| | | | | | piecePack 0-1
| | | | | | - choose -
| | | | | | | piecePackText 1-1
| | | | | | - or -
| | | | | | | pieceInnWrap1 1-1
| | | | | | | pieceInnWrap2 0-1

```

```

| | | | | | | pieceOutWrap 0-1
| | | | | | | - end choose -
| | | | | | | - or -
| | | | | | | | acsPack 0-1
| | | | | | | | - choose -
| | | | | | | | | acsPackCode 1-1
| | | | | | | | | - or -
| | | | | | | | | acsPackText 1-1
| | | | | | | | | - end choose -
| | | | | | | | | - or -
| | | | | | | | | | garPack 0-1
| | | | | | | | | | - choose -
| | | | | | | | | | | garPackCode 1-1
| | | | | | | | | | | - or -
| | | | | | | | | | | garPackText 1-1
| | | | | | | | | | | - end choose -
| | | | | | | | | | | - end choose -
| | | | | | | | | | | sortableIndicator 0-1
| | | | | | | | | | | stackabilityLevel 0-1
| | | | | | | | | | | handlingType 0-1
| | | | | | | | | | | @ln [Optional]
| | | | | | | | | | | volume 0-1
| | | | | | | | | | | @um [Required]
| | | | | | | | | | | netWeight 0-1
| | | | | | | | | | | @um [Required]
| | | | | | | | | | | grossWeight 0-1
| | | | | | | | | | | @um [Required]
| | | | | | | | | | | note 0-99
| | | | | | | | | | | @numberingOrg [Optional]
| | | | | | | | | | | @codeList [Optional]
| | | | | | | | | | | @noteLabel [Optional]
| | | | | | | | | | | itemsPerPackage 0-1
| | | | | | | | | | | @um [Required]
| | | | | | | | | | | minItemsPerPackage 0-1
| | | | | | | | | | | @um [Required]
| | | | | | | | | | | fillingCriterion 0-9
| | | | | | | | | | | @progr [Optional]
| | | | | | | | | | | packageQty 0-1
| | | | | | | | | | | packageN 0-unbounded
| | | | | | | | | | | @numberingOrg [Optional]
| | | | | | | | | | | @packageContainerN [Optional]
| | | | | | | | | | | EPCList 0-1
| | | | | | | | | | | | EPC 1-unbounded
| | | | | | | | | | | | @numberingOrg [Optional]
| | | | | | | | | | | | @TID [Optional]
| | | | | | | | | | | note 0-99
| | | | | | | | | | | @numberingOrg [Optional]
| | | | | | | | | | | @codeList [Optional]
| | | | | | | | | | | @noteLabel [Optional]
| | | | | | | | | | | garComInfo 0-1
| | | | | | | | | | | @endUse [Optional]
| | | | | | | | | | | season 0-1
| | | | | | | | | | | @numberingOrg [Optional]
| | | | | | | | | | | @codeList [Optional]
| | | | | | | | | | | @listName [Optional]
| | | | | | | | | | | @listVersion [Optional]
| | | | | | | | | | | brand 0-1
| | | | | | | | | | | @numberingOrg [Optional]
| | | | | | | | | | | @codeList [Optional]
| | | | | | | | | | | @listName [Optional]
| | | | | | | | | | | @listVersion [Optional]

```

```

| | | productLine 0-1
| | |   @numberingOrg [Optional]
| | |   @codeList [Optional]
| | |   @listName [Optional]
| | |   @listVersion [Optional]
| | | project 0-1
| | | operationalCode 0-19
| | |   @numberingOrg [Optional]
| | |   @codeList [Optional]
| | |   @listName [Optional]
| | |   @listVersion [Optional]
| | |   @codeQualifier [Optional]
| | | deliveryDate 0-1
| | |   @dateForm [Optional]
| | | specDate 0-1
| | |   @dateForm [Optional]
| | | note 0-99
| | |   @numberingOrg [Optional]
| | |   @codeList [Optional]
| | |   @noteLabel [Optional]
| | | endUseGroup 0-99
| | |   endUseGroupIcd 1-1
| | |   qty 0-1
| | |     @um [Required]
| | |   csRange 0-1
| | |     @numberingOrg [Optional]
| | |     @sizeSystemNat [Optional]
| | |     @sizeSystemSeg [Optional]
| | |     @sizeSystemBase [Optional]
| | |     @sizeSystemID [Optional]
| | |     | color 0-1
| | |     |   @numberingOrg [Optional]
| | |     |   @codeList [Optional]
| | |     |   @listName [Optional]
| | |     |   @listVersion [Optional]
| | |     | garmentVariant 0-9
| | |     |   variantType 1-1
| | |     |     @numberingOrg [Optional]
| | |     |     @codeList [Optional]
| | |     |     @listName [Optional]
| | |     |     @listVersion [Optional]
| | |     |   variantCode 1-1
| | |     |     @numberingOrg [Optional]
| | |     |     @codeList [Optional]
| | |     |     @listName [Optional]
| | |     |     @listVersion [Optional]
| | |     drop 0-1
| | |     | @codeList [Optional]
| | |     sizeMatrix 1-1
| | |     | sizeRow 1-99
| | |     |   | additionalComponentCode 0-9
| | |     |   |   @numberingOrg [Optional]
| | |     |   |   @codeList [Optional]
| | |     |   |   @listName [Optional]
| | |     |   |   @listVersion [Optional]
| | |     |   | drop 0-1
| | |     |   |   @codeList [Optional]
| | |     |   | size 1-1
| | |     |   |   @codeList [Optional]
| | |     |   | qty 0-1
| | |     |   | @um [Required]

```



```

- or -
| | | | | acsPack 0-1
| | | | |   - choose -
| | | | |     | | acsPackCode 1-1
| | | | |   - or -
| | | | |     | | acsPackText 1-1
| | | | |   - end choose -
- or -
| | | | | | garPack 0-1
| | | | | |   - choose -
| | | | | |     | | garPackCode 1-1
| | | | | |   - or -
| | | | | |     | | garPackText 1-1
| | | | | |   - end choose -
- end choose -
| | | | | | sortableIndicator 0-1
| | | | | | stackabilityLevel 0-1
| | | | | | handlingType 0-1
| | | | | |   @In [Optional]
| | | | | | volume 0-1
| | | | | |   @um [Required]
| | | | | | netWeight 0-1
| | | | | |   @um [Required]
| | | | | | grossWeight 0-1
| | | | | |   @um [Required]
| | | | | | note 0-99
| | | | | |   @numberingOrg [Optional]
| | | | | |   @codeList [Optional]
| | | | | |   @noteLabel [Optional]
| | | | | | itemsPerPackage 0-1
| | | | | |   @um [Required]
| | | | | | minItemsPerPackage 0-1
| | | | | |   @um [Required]
| | | | | | fillingCriterion 0-9
| | | | | |   @progr [Optional]
| | | | | | packageQty 0-1
| | | | | | packageN 0-unbounded
| | | | | |   @numberingOrg [Optional]
| | | | | |   @packageContainerN [Optional]
| | | | | | EPCList 0-1
| | | | | |   | EPC 1-unbounded
| | | | | |   |   @numberingOrg [Optional]
| | | | | |   |   @TID [Optional]
| | | | | | dtScheme 0-1
| | | | | |   @taxType [Required]
| | | | | |   | taxCategory 0-1
| | | | | |   | taxRate 0-1
| | | | | |   | legalRef 0-1
| | | | | |   |   @codeList [Required]
| | | | | |   | note 0-99
| | | | | |   |   @numberingOrg [Optional]
| | | | | |   |   @codeList [Optional]
| | | | | |   |   @noteLabel [Optional]
| | | | | | note 0-99
| | | | | |   @numberingOrg [Optional]
| | | | | |   @codeList [Optional]
| | | | | |   @noteLabel [Optional]

```

## 2.2 Detailed description of document elements

Following tables show all elements (complex and simple) used in this document. Description includes: 1) element's information: xml tag, name, brief description, data type and syntax constraints; 2) information about use of the element in a particular position in the document: xpath and possible associated notes.

### 2.2.1 Complex elements (Aggregate Business Information Entities)

Complex elements are those elements whose content is composed of other elements (childs). Complex elements are alphabetically ordered.

<b>acsCode</b>	full codification identifying an accessory product usually coupled with garment or other fashion product (XPath KnitClothOrder/KCCObody/KCCOitem/apparelComponent/acsComponent/acsCode) 1-1 (XPath KnitClothOrder/KCCObody/KCCOitem/garTecSheet/garConsumptionSet/acsCode) 1-1 (XPath KnitClothOrder/KCCObody/KCCOitem/phase/garConsumptionSet/acsCode) 1-1
<b>acsComponent</b>	identification details of a accessory used in a sub-contracted manufacturing operation (XPath KnitClothOrder/KCCObody/KCCOitem/apparelComponent/acsComponent) 0-99
<b>acsPack</b>	type of wrapping or packing of the accessory (XPath KnitClothOrder/KCCObody/KCCOitem/phase/packages/handlingChar/acsPack) 0-1 (XPath KnitClothOrder/KCCObody/KCCOitem/packages/handlingChar/acsPack) 0-1
<b>allowanceCharge</b>	Allowances and Charges related to an Order or a contract (XPath KnitClothOrder/terms/allowanceCharge) 0-9
<b>apparelComponent</b>	identification details of a component used in the sub-contracted production of an apparel article or of one of its part (XPath KnitClothOrder/KCCObody/KCCOitem/apparelComponent) 0-9
<b>apparelProd</b>	manufacturing specifications for a garment article to be obtained from an operation of sub-contracted production (XPath KnitClothOrder/KCCObody/KCCOitem/apparelProd) 1-1
<b>appMnfrOperation</b>	details of a manufacturing operation used for garment production (XPath KnitClothOrder/KCCObody/KCCOitem/appMnfrOperation) 0-9
<b>attachment</b>	an attached document. An attachment can refer to an external document or be included with the document being exchanged (XPath KnitClothOrder/KCCOheader/refDoc/attachment) 0-1 (XPath KnitClothOrder/KCCObody/KCCOitem/garTecSheet/refDoc/attachment) 0-1 (XPath KnitClothOrder/KCCObody/KCCOitem/phase/refDoc/attachment) 0-1 (XPath KnitClothOrder/KCCObody/KCCOitem/appMnfrOperation/refDoc/attachment) 0-1 (XPath KnitClothOrder/KCCObody/KCCOitem/apparelComponent/yarnComponent/refDoc/attachment) 0-1 (XPath KnitClothOrder/KCCObody/KCCOitem/apparelComponent/fabricComponent/refDoc/attachment) 0-1 (XPath KnitClothOrder/KCCObody/KCCOitem/apparelComponent/acsComponent/refDoc/attachment) 0-1 (XPath KnitClothOrder/KCCObody/KCCOitem/apparelComponent/garmentPartComponent/refDoc/attachment) 0-1

<b>buyer</b>	details of the Buyer (party that buys the good or service that is object of the current collaborative process) - base type: Nad, (XPath KnitClothOrder/KCCOheader/buyer) 1-1
<b>csRange</b>	range of color-size for a fashion article (XPath KnitClothOrder/KCCObody/KCCOitem/endUseGroup/csRange) 0-1 (XPath KnitClothOrder/KCCObody/KCCOitem/phase/lotDetails/csRange) 0-99 (XPath KnitClothOrder/KCCObody/KCCOitem/apparelProd/csRange) 0-99
<b>dtScheme</b>	set of data usable to declare the duty or tax applied (XPath KnitClothOrder/KCCObody/KCCOitem/dtScheme) 0-1 (XPath KnitClothOrder/terms/allowanceCharge/dtScheme) 0-1
<b>endUseGroup</b>	references that connect the instances of a product to a group of articles (such as a group of items used in a shop window) of which it will be part of. (XPath KnitClothOrder/KCCObody/KCCOitem/endUseGroup) 0-99
<b>EPCList</b>	list of identifiers used for tracing a physical item with RFID technology (XPath KnitClothOrder/KCCObody/KCCOitem/phase/packages/EPCList) 0-1 - note: <i>this element is DEPRECATED, please use the specific elements</i> (XPath KnitClothOrder/KCCObody/KCCOitem/packages/EPCList) 0-1 - note: <i>this element is DEPRECATED, please use the specific elements</i>
<b>externalReference</b>	details about an external object, such as a document stored at a remote location (XPath KnitClothOrder/KCCOheader/refDoc/attachment/externalReference) 0-99 (XPath KnitClothOrder/KCCObody/KCCOitem/apparelComponent/acsComponent/refDoc/attachment/externalReference) 0-99 (XPath KnitClothOrder/KCCObody/KCCOitem/appMnfrOperation/refDoc/attachment/externalReference) 0-99 (XPath KnitClothOrder/KCCObody/KCCOitem/apparelComponent/garmentPartComponent/refDoc/attachment/externalReference) 0-99 (XPath KnitClothOrder/KCCObody/KCCOitem/garTecSheet/refDoc/attachment/externalReference) 0-99 (XPath KnitClothOrder/KCCObody/KCCOitem/apparelComponent/yarnComponent/refDoc/attachment/externalReference) 0-99 (XPath KnitClothOrder/KCCObody/KCCOitem/apparelComponent/fabricComponent/refDoc/attachment/externalReference) 0-99 (XPath KnitClothOrder/KCCObody/KCCOitem/phase/refDoc/attachment/externalReference) 0-99
<b>fabricComponent</b>	identification details of a fabric used in a sub-contracted manufacturing operation (XPath KnitClothOrder/KCCObody/KCCOitem/apparelComponent/fabricComponent) 0-9
<b>fabricCompos</b>	composition of the fabric according to the Directory 97/37/CE (XPath KnitClothOrder/KCCObody/KCCOitem/garTecSheet/fabricCompos) 0-1
<b>garComInfo</b>	miscellaneous commercial information. (XPath KnitClothOrder/KCCObody/KCCOitem/garComInfo) 0-1 - note: <i>it should be used in this position instead of at document level only if the information apply only to the current line.</i> (XPath KnitClothOrder/garComInfo) 0-1
<b>garConsumption</b>	consumption of the component for the given size range (XPath KnitClothOrder/KCCObody/KCCOitem/phase/garConsumptionSet/garConsumption) 1-9 (XPath KnitClothOrder/KCCObody/KCCOitem/garTecSheet/garConsumptionSet/garConsumption) 1-9
<b>garConsumptionSet</b>	components and average prescribed or effective consumptions for a garment (XPath KnitClothOrder/KCCObody/KCCOitem/phase/garConsumptionSet) 0-99 (XPath KnitClothOrder/KCCObody/KCCOitem/garTecSheet/garConsumptionSet) 0-99

<b>garMea</b>	attribute's measure for the given size (XPath KnitClothOrder/KCCObody/KCCOitem/garTecSheet/ garMeaSet/garMea) 1-9
<b>garMeaSet</b>	physical measures of the set of sizes of a garment (XPath KnitClothOrder/KCCObody/KCCOitem/garTecSheet/garMeaSet) 0-99
<b>garmentCode</b>	codification of the garment product (XPath KnitClothOrder/KCCObody/KCCOitem/phase/garConsumptionSet/garmentCode) 1-1 (XPath KnitClothOrder/KCCObody/KCCOitem/garTecSheet/garmentCode) 1-2 (XPath KnitClothOrder/KCCObody/KCCOitem/garTecSheet/ garConsumptionSet/garmentCode) 1-1 (XPath KnitClothOrder/KCCObody/KCCOitem/apparelProd/garmentCode) 1-2 - note: <i>this element can have two instances only if the numbering organisations are different</i>
<b>garmentCodeA</b>	codification of the garment product- type A (XPath KnitClothOrder/KCCObody/KCCOitem/apparelProd/ garmentCode/garmentCodeA) 1-1 - note: <i>here the barcode EAN-13 or EAN-8 should be specified</i> (XPath KnitClothOrder/KCCObody/KCCOitem/garTecSheet/ garConsumptionSet/garmentCode/garmentCodeA) 1-1 - note: <i>here the barcode EAN-13 or EAN-8 should be specified</i> (XPath KnitClothOrder/KCCObody/KCCOitem/phase/garConsumptionSet/garmentCode/garmentCodeA) 1-1 - note: <i>here the barcode EAN-13 or EAN-8 should be specified</i> (XPath KnitClothOrder/KCCObody/KCCOitem/garTecSheet/ garmentCode/garmentCodeA) 1-1 - note: <i>here the barcode EAN-13 or EAN-8 should be specified</i>
<b>garmentCodeB</b>	codification of the garment product - type B (XPath KnitClothOrder/KCCObody/KCCOitem/garTecSheet/ garConsumptionSet/garmentCode/garmentCodeB) 1-1 (XPath KnitClothOrder/KCCObody/KCCOitem/phase/garConsumptionSet/garmentCode/garmentCodeB) 1-1 (XPath KnitClothOrder/KCCObody/KCCOitem/apparelProd/ garmentCode/garmentCodeB) 1-1 (XPath KnitClothOrder/KCCObody/KCCOitem/garTecSheet/ garmentCode/garmentCodeB) 1-1
<b>garmentPartCode</b>	codification of the component or part of a fashion article (XPath KnitClothOrder/KCCObody/KCCOitem/apparelProd/garmentPartCode) 1-2 - note: <i>this element can have two instances only if the numbering organisations are different</i> (XPath KnitClothOrder/KCCObody/KCCOitem/phase/garConsumptionSet/garmentPartCode) 1-1 (XPath KnitClothOrder/KCCObody/KCCOitem/garTecSheet/ garConsumptionSet/garmentPartCode) 1-1 (XPath KnitClothOrder/KCCObody/KCCOitem/apparelComponent/ garmentPartComponent/garmentPartCode) 1-1
<b>garmentPartComponent</b>	identification details of a FASHION product part used in a sub-contracted manufacturing operation (XPath KnitClothOrder/KCCObody/KCCOitem/apparelComponent/garmentPartComponent) 0-9 - note: <i>used only for components that are semifinished products with their own code</i>
<b>garmentVariant</b>	garment product variant (XPath KnitClothOrder/KCCObody/KCCOitem/garTecSheet/ garmentCode/garmentCodeB/garmentVariant) 0-9



	<p>(XPath KnitClothOrder/KCCObody/KCCOitem/phase/garConsumptionSet/garmentCode/garmentCodeB/garmentVariant) 0-9</p> <p>(XPath KnitClothOrder/KCCObody/KCCOitem/garTecSheet/garConsumptionSet/garmentCode/garmentCodeB/garmentVariant) 0-9</p> <p>(XPath KnitClothOrder/KCCObody/KCCOitem/phase/lotDetails/csRange/garmentVariant) 0-9</p> <p>- note: <i>used only if not already specified in the article code</i></p> <p>(XPath KnitClothOrder/KCCObody/KCCOitem/apparelProd/garmentCode/garmentCodeB/garmentVariant) 0-9</p> <p>(XPath KnitClothOrder/KCCObody/KCCOitem/endUseGroup/csRange/garmentVariant) 0-9</p> <p>- note: <i>used only if not already specified in the article code</i></p> <p>(XPath KnitClothOrder/KCCObody/KCCOitem/apparelProd/csRange/garmentVariant) 0-9</p> <p>- note: <i>used only if not already specified in the article code</i></p>
<b>garPack</b>	<p>the packaging mode of the item or a part of it.</p> <p>(XPath KnitClothOrder/KCCObody/KCCOitem/phase/packages/handlingChar/garPack) 0-1</p> <p>(XPath KnitClothOrder/KCCObody/KCCOitem/packages/handlingChar/garPack) 0-1</p>
<b>garSizeSet</b>	<p>size table for a garment</p> <p>(XPath KnitClothOrder/KCCObody/KCCOitem/garTecSheet/garSizeSet) 0-1</p>
<b>garSizeTier</b>	<p>definition of the range of sizes associated with a given code</p> <p>(XPath KnitClothOrder/KCCObody/KCCOitem/garTecSheet/garSizeSet/garSizeTier) 1-9</p>
<b>garTecSheet</b>	<p>garment technical sheet</p> <p>(XPath KnitClothOrder/KCCObody/KCCOitem/garTecSheet) 0-1</p>
<b>handlingChar</b>	<p>features of an item (item or package) useful for its transport and warehouse management.</p> <p>(XPath KnitClothOrder/KCCObody/KCCOitem/phase/packages/handlingChar) 0-1</p> <p>- note: <i>in this case the characteristics are related to the package.</i></p> <p>(XPath KnitClothOrder/KCCObody/KCCOitem/packages/handlingChar) 0-1</p> <p>- note: <i>in this case the characteristics are related to the package.</i></p>
<b>insPayment</b>	<p>payment details for payment by installments</p> <p>(XPath KnitClothOrder/terms/insPayment) 0-5</p> <p>- note: <i>excluded the case of offers, this set of data is alternative to payment set and must be iterated for each payment installment</i></p>
<b>itemIdentification</b>	<p>serial identification of a product unit</p> <p>(XPath KnitClothOrder/KCCObody/KCCOitem/apparelProd/csRange/sizeMatrix/sizeRow/itemsList/itemIdentification) 1-unbounded</p> <p>- note: <i>identification of the single product unit contained in the list</i></p> <p>(XPath KnitClothOrder/KCCObody/KCCOitem/phase/lotDetails/csRange/sizeMatrix/sizeRow/itemsList/itemIdentification) 1-unbounded</p> <p>- note: <i>identification of the single product unit contained in the list</i></p> <p>(XPath KnitClothOrder/KCCObody/KCCOitem/endUseGroup/csRange/sizeMatrix/sizeRow/itemsList/itemIdentification) 1-unbounded</p> <p>- note: <i>identification of the single product unit contained in the list</i></p> <p>(XPath KnitClothOrder/KCCObody/KCCOitem/apparelComponent/fabricComponent/itemsList/itemIdentification) 1-unbounded</p> <p>- note: <i>identification of the single product unit contained in the list</i></p> <p>(XPath KnitClothOrder/KCCObody/KCCOitem/progress/itemsList/itemIdentification) 1-unbounded</p> <p>- note: <i>identification of the single product unit contained in the list</i></p>
<b>itemsList</b>	<p>list of the single product units</p> <p>(XPath KnitClothOrder/KCCObody/KCCOitem/apparelComponent/fabricComponent/itemsList) 0-unbounded</p> <p>- note: <i>it may be used to identify the pieces/chains that the Subcontractor must use for the commissioned work with multiple serial Ids for each one</i></p>

	<p>(XPath KnitClothOrder/KCCObody/KCCOitem/progress/itemsList) 0-1  (XPath KnitClothOrder/KCCObody/KCCOitem/phase/lotDetails/csRange/sizeMatrix/sizeRow/itemsList) 0-1  - note: <i>the usage in this position is alternative to its usage within the document line element</i>  (XPath KnitClothOrder/KCCObody/KCCOitem/apparelProd/csRange/sizeMatrix/sizeRow/itemsList) 0-1  - note: <i>the usage in this position is alternative to its usage within the document line element</i>  (XPath KnitClothOrder/KCCObody/KCCOitem/endUseGroup/csRange/sizeMatrix/sizeRow/itemsList) 0-1  - note: <i>the usage in this position is alternative to its usage within the document line element</i></p>
<b>KCCObody</b>	<p>body of the document FASHION COMMISSION ORDER (ex GARMENT COMMISSION ORDER)  (XPath KnitClothOrder/KCCObody) 1-1</p>
<b>KCCOheader</b>	<p>header of the document FASHION COMMISSION ORDER  (XPath KnitClothOrder/KCCOheader) 1-1</p>
<b>KCCOitem</b>	<p>line of the document GARMENT COMMISSION ORDER  (XPath KnitClothOrder/KCCObody/KCCOitem) 1-unbounded</p>
<b>lotDetails</b>	<p>details about the lot to be assigned to a group of items.  (XPath KnitClothOrder/KCCObody/KCCOitem/phase/lotDetails) 0-99</p>
<b>packageDim</b>	<p>dimensions of a transport package  (XPath KnitClothOrder/KCCObody/KCCOitem/phase/packages/packageDim) 0-1  (XPath KnitClothOrder/KCCObody/KCCOitem/packages/packageDim) 0-1</p>
<b>packages</b>	<p>describes the composition of the transport packaging. Each element corresponds to a type of package: type, quantity, hierarchic level, list of identifiers of the single packages  (XPath KnitClothOrder/KCCObody/KCCOitem/phase/packages) 0-99  (XPath KnitClothOrder/KCCObody/KCCOitem/packages) 0-99</p>
<b>payment</b>	<p>payment details for payment all in one  (XPath KnitClothOrder/terms/payment) 0-5  - note: <i>excluded the case of offers, this set of data is alternative to insPayment, it can be iterated to specify alternative terms of payment (e.g.: 60 days or 30 days with 3% discount)</i></p>
<b>phase</b>	<p>a production phase of a fashion product.  (XPath KnitClothOrder/KCCObody/KCCOitem/phase) 0-99</p>
<b>piecePack</b>	<p>type of wrapping or packing of the fabric pieces  (XPath KnitClothOrder/KCCObody/KCCOitem/packages/handlingChar/piecePack) 0-1  (XPath KnitClothOrder/KCCObody/KCCOitem/phase/packages/handlingChar/piecePack) 0-1</p>
<b>progress</b>	<p>description of the progress of a production lot in a manufacturing process  (XPath KnitClothOrder/KCCObody/KCCOitem/progress) 0-9  - note: <i>In this case the progress element states an expected date for the production steps.</i></p>
<b>refDoc</b>	<p>identification of a document and of an item thereof, to which the message makes reference  (XPath KnitClothOrder/KCCObody/KCCOitem/appMnfrOperation/refDoc) 0-1  (XPath KnitClothOrder/KCCObody/KCCOitem/apparelComponent/fabricComponent/refDoc) 0-1  - note: <i>here the delivery documents can be specified</i>  (XPath KnitClothOrder/KCCObody/KCCOitem/apparelComponent/garmentPartComponent/refDoc) 0-1  (XPath KnitClothOrder/KCCObody/KCCOitem/apparelComponent/acsComponent/refDoc) 0-1</p>

	<p>(XPath KnitClothOrder/KCCObody/KCCOitem/garTecSheet/refDoc) 0-9  (XPath KnitClothOrder/KCCOheader/refDoc) 0-9  (XPath KnitClothOrder/KCCObody/KCCOitem/apparelComponent/yarnComponent/refDoc) 0-1  - note: <i>here the delivery document can be specified</i>  (XPath KnitClothOrder/KCCObody/KCCOitem/phase/refDoc) 0-99</p>
<b>sizeMatrix</b>	<p>size matrix of an apparel product  (XPath KnitClothOrder/KCCObody/KCCOitem/endUseGroup/csRange/sizeMatrix) 1-1  (XPath KnitClothOrder/KCCObody/KCCOitem/phase/lotDetails/csRange/sizeMatrix) 1-1  (XPath KnitClothOrder/KCCObody/KCCOitem/apparelProd/csRange/sizeMatrix) 1-1</p>
<b>sizeRow</b>	<p>size matrix row of an apparel product  (XPath KnitClothOrder/KCCObody/KCCOitem/endUseGroup/csRange/sizeMatrix/sizeRow) 1-99  (XPath KnitClothOrder/KCCObody/KCCOitem/phase/lotDetails/csRange/sizeMatrix/sizeRow) 1-99  (XPath KnitClothOrder/KCCObody/KCCOitem/apparelProd/csRange/sizeMatrix/sizeRow) 1-99</p>
<b>subContractor</b>	<p>details of the Sub-contractor  - base type: Nad,  (XPath KnitClothOrder/KCCOheader/subContractor) 1-1</p>
<b>terms</b>	<p>details of the commercial obligations for payment and delivery  (XPath KnitClothOrder/terms) 0-1</p>
<b>texCode</b>	<p>full codification of the textile product  (XPath KnitClothOrder/KCCObody/KCCOitem/apparelComponent/fabricComponent/texCode) 1-1  (XPath KnitClothOrder/KCCObody/KCCOitem/garTecSheet/garConsumptionSet/texCode) 1-1  (XPath KnitClothOrder/KCCObody/KCCOitem/phase/garConsumptionSet/texCode) 1-1</p>
<b>thirdParty</b>	<p>details of the Third Party, different from Buyer or Supplier  - base type: Nad,  (XPath KnitClothOrder/KCCObody/KCCOitem/phase/thirdParty) 0-9  (XPath KnitClothOrder/KCCOheader/thirdParty) 0-5  - note: <i>here the Party to whom the Subcontractor must send the semi-finished products for subsequent operations can be specified</i>  (XPath KnitClothOrder/KCCObody/KCCOitem/thirdParty) 0-5</p>
<b>trade</b>	<p>general terms of trade for the specified supply  (XPath KnitClothOrder/terms/trade) 0-1</p>
<b>transInfo</b>	<p>details of transport: mode, carrier and delivery place  (XPath KnitClothOrder/terms/transInfo) 0-5</p>
<b>yarnCode</b>	<p>full codification of a yarn product  (XPath KnitClothOrder/KCCObody/KCCOitem/phase/garConsumptionSet/yarnCode) 1-1  (XPath KnitClothOrder/KCCObody/KCCOitem/apparelComponent/yarnComponent/yarnCode) 1-1  - note: <i>here is the code of the component used in the yarn manufacturing operation</i>  (XPath KnitClothOrder/KCCObody/KCCOitem/garTecSheet/garConsumptionSet/yarnCode) 1-1</p>
<b>yarnComponent</b>	<p>identification details of a yarn used in a sub-contracted manufacturing operation  (XPath KnitClothOrder/KCCObody/KCCOitem/apparelComponent/yarnComponent) 0-9</p>

<b>yarnInWrap</b>	details specifying the inner wrapping of a yarn product (XPath KnitClothOrder/KCCObody/KCCOitem/phase/packages/handlingChar/yarnPack/yarnInWrap) 0-1 (XPath KnitClothOrder/KCCObody/KCCOitem/packages/handlingChar/yarnPack/yarnInWrap) 0-1
<b>yarnPack</b>	details of type of presentation used for the yarn (XPath KnitClothOrder/KCCObody/KCCOitem/phase/packages/handlingChar/yarnPack) 0-1 (XPath KnitClothOrder/KCCObody/KCCOitem/packages/handlingChar/yarnPack) 0-1
<b>yarnReel</b>	details of the packaging of a yarn product (bobbin and reel,..) (XPath KnitClothOrder/KCCObody/KCCOitem/phase/packages/handlingChar/yarnPack/yarnReel) 1-1 (XPath KnitClothOrder/KCCObody/KCCOitem/packages/handlingChar/yarnPack/yarnReel) 1-1

## 2.2.2 Simple elements (Basic Business Information Entities)

Simple elements are those elements whose content is characterized by a data type plus a domain of possible values. Simple elements are alphabetically ordered.

AC_amount	amount of an Allowance or Charge - base type: decimal, fraction digits: 2, (XPath KnitClothOrder/terms/allowanceCharge/AC_amount) 1-1
AC_category	coded specification of an Allowance or Charge - base type: string, cod. table: T41 <a href="http://www.ebiz.enea.it/moda-ml/repository/codelist/draft/gc_T41.xml">http://www.ebiz.enea.it/moda-ml/repository/codelist/draft/gc_T41.xml</a> (XPath KnitClothOrder/terms/allowanceCharge/AC_category) 1-1
AC_categoryText	free text description of an Allowance or Charge - base type: string, max length: 250, (XPath KnitClothOrder/terms/allowanceCharge/AC_categoryText) 1-1
AC_percent	amount of an Allowance or Charge as a percentage - base type: decimal, max inclusive: 100, fraction digits: 2, (XPath KnitClothOrder/terms/allowanceCharge/AC_percent) 1-1
acsPackCode	code specifying the type of wrapping or packing used for the accessory - base type: string, (XPath KnitClothOrder/KCCObody/KCCOitem/phase/packages/handlingChar/acsPack/acsPackCode) 1-1 (XPath KnitClothOrder/KCCObody/KCCOitem/packages/handlingChar/acsPack/acsPackCode) 1-1
acsPackText	free text specifying the type of wrapping or packing used for the accessory - base type: string, max length: 250, (XPath KnitClothOrder/KCCObody/KCCOitem/phase/packages/handlingChar/acsPack/acsPackText) 1-1 (XPath KnitClothOrder/KCCObody/KCCOitem/packages/handlingChar/acsPack/acsPackText) 1-1
added	additional code of the product (complementing the formers) - base type: string, max length: 80, (XPath KnitClothOrder/KCCObody/KCCOitem/phase/garConsumptionSet/texCode/added) 0-9 - note: <i>here an additional codification (see table T44) can be specified</i> (XPath KnitClothOrder/KCCObody/KCCOitem/phase/garConsumptionSet/garmentPartCode/added) 0-19

	<p>(XPath KnitClothOrder/KCCObody/KCCOitem/apparelComponent/yarnComponent/yarnCode/added) 0-9</p> <p>- note: <i>here an additional codification (see table T44) can be specified</i></p> <p>(XPath KnitClothOrder/KCCObody/KCCOitem/garTecSheet/garConsumptionSet/garmentCode/garmentCodeB/added) 0-9</p> <p>(XPath KnitClothOrder/KCCObody/KCCOitem/phase/garConsumptionSet/yarnCode/added) 0-9</p> <p>- note: <i>here an additional codification (see table T44) can be specified</i></p> <p>(XPath KnitClothOrder/KCCObody/KCCOitem/apparelProd/garmentCode/garmentCodeB/added) 0-9</p> <p>(XPath KnitClothOrder/KCCObody/KCCOitem/garTecSheet/garConsumptionSet/acsCode/added) 0-9</p> <p>- note: <i>here an additional codification (see table T44) can be specified</i></p> <p>(XPath KnitClothOrder/KCCObody/KCCOitem/phase/garConsumptionSet/garmentCode/garmentCodeB/added) 0-9</p> <p>(XPath KnitClothOrder/KCCObody/KCCOitem/garTecSheet/garmentCode/garmentCodeB/added) 0-9</p> <p>(XPath KnitClothOrder/KCCObody/KCCOitem/garTecSheet/garConsumptionSet/texCode/added) 0-9</p> <p>- note: <i>here an additional codification (see table T44) can be specified</i></p> <p>(XPath KnitClothOrder/KCCObody/KCCOitem/apparelComponent/acsComponent/acsCode/added) 0-9</p> <p>- note: <i>here an additional codification (see table T44) can be specified</i></p> <p>(XPath KnitClothOrder/KCCObody/KCCOitem/apparelProd/garmentPartCode/added) 0-19</p> <p>(XPath KnitClothOrder/KCCObody/KCCOitem/garTecSheet/garConsumptionSet/yarnCode/added) 0-9</p> <p>- note: <i>here an additional codification (see table T44) can be specified</i></p> <p>(XPath KnitClothOrder/KCCObody/KCCOitem/garTecSheet/garConsumptionSet/garmentPartCode/added) 0-19</p> <p>(XPath KnitClothOrder/KCCObody/KCCOitem/phase/garConsumptionSet/acsCode/added) 0-9</p> <p>- note: <i>here an additional codification (see table T44) can be specified</i></p> <p>(XPath KnitClothOrder/KCCObody/KCCOitem/apparelComponent/garmentPartComponent/garmentPartCode/added) 0-19</p> <p>(XPath KnitClothOrder/KCCObody/KCCOitem/apparelComponent/fabricComponent/texCode/added) 0-9</p> <p>- note: <i>here an additional codification (see table T44) can be specified</i></p>
additionalComponentCode	<p>an additional code to identify a fashion product or a part of it (it is a way to codify the item, but it is not one of the codes to identify it). It is not a serial identifier.</p> <p>- base type: string,</p> <p>(XPath KnitClothOrder/KCCObody/KCCOitem/apparelProd/csRange/sizeMatrix/sizeRow/additionalComponentCode) 0-9</p> <p>(XPath KnitClothOrder/KCCObody/KCCOitem/phase/lotDetails/csRange/sizeMatrix/sizeRow/additionalComponentCode) 0-9</p> <p>(XPath KnitClothOrder/KCCObody/KCCOitem/endUseGroup/csRange/sizeMatrix/sizeRow/additionalComponentCode) 0-9</p>
additionalIdentifier	<p>additional identification code of a Party, for example customs registries or others</p> <p>- base type: string, max length: 15,</p> <p>(XPath KnitClothOrder/KCCOheader/buyer/additionalIdentifier) 0-9</p> <p>- note: <i>identifiers for example for exports, such as MID (Manufacturer Identification Code), EORI (E.O.R.I. - Economic Operator Registration and Identification)</i></p>
@addType	<p>qualifier of the additional coding of a product</p> <p>- base type: string, cod. table: T44</p> <p><a href="http://www.ebiz.enea.it/moda-ml/repository/codelist/draft/gc_T44.xml">http://www.ebiz.enea.it/moda-ml/repository/codelist/draft/gc_T44.xml</a></p>

(XPath KnitClothOrder/KCCObody/KCCOitem/phase/garConsumptionSet/garmentCode/garmentCodeB/added/@addType) [Optional]  
- nota: *addType* allows the clarification of the meaning of the added element content; it is strongly suggested to use it always.

(XPath KnitClothOrder/KCCObody/KCCOitem/apparelComponent/yarnComponent/yarnCode/added/@addType) [Optional]  
- nota: *addType* allows the clarification of the meaning of the added element content; it is strongly suggested to use it always.

(XPath KnitClothOrder/KCCObody/KCCOitem/apparelComponent/garmentPartComponent/garmentPartCode/added/@addType) [Optional]  
- nota: *addType* allows the clarification of the meaning of the added element content; it is strongly suggested to use it always.

(XPath KnitClothOrder/KCCObody/KCCOitem/apparelComponent/acsComponent/acsCode/added/@addType) [Optional]  
- nota: *addType* allows the clarification of the meaning of the added element content; it is strongly suggested to use it always.

(XPath KnitClothOrder/KCCObody/KCCOitem/garTecSheet/garmentCode/garmentCodeB/added/@addType) [Optional]  
- nota: *addType* allows the clarification of the meaning of the added element content; it is strongly suggested to use it always.

(XPath KnitClothOrder/KCCObody/KCCOitem/phase/garConsumptionSet/garmentPartCode/added/@addType) [Optional]  
- nota: *addType* allows the clarification of the meaning of the added element content; it is strongly suggested to use it always.

(XPath KnitClothOrder/KCCObody/KCCOitem/apparelComponent/fabricComponent/texCode/added/@addType) [Optional]  
- nota: *addType* allows the clarification of the meaning of the added element content; it is strongly suggested to use it always.

(XPath KnitClothOrder/KCCObody/KCCOitem/apparelProd/garmentPartCode/added/@addType) [Optional]  
- nota: *addType* allows the clarification of the meaning of the added element content; it is strongly suggested to use it always.

(XPath KnitClothOrder/KCCObody/KCCOitem/phase/garConsumptionSet/yarnCode/added/@addType) [Optional]  
- nota: *addType* allows the clarification of the meaning of the added element content; it is strongly suggested to use it always.

(XPath KnitClothOrder/KCCObody/KCCOitem/garTecSheet/garConsumptionSet/garmentPartCode/added/@addType) [Optional]  
- nota: *addType* allows the clarification of the meaning of the added element content; it is strongly suggested to use it always.

(XPath KnitClothOrder/KCCObody/KCCOitem/garTecSheet/garConsumptionSet/texCode/added/@addType) [Optional]  
- nota: *addType* allows the clarification of the meaning of the added element content; it is strongly suggested to use it always.

(XPath KnitClothOrder/KCCObody/KCCOitem/phase/garConsumptionSet/acsCode/added/@addType) [Optional]  
- nota: *addType* allows the clarification of the meaning of the added element content; it is strongly suggested to use it always.

(XPath KnitClothOrder/KCCObody/KCCOitem/apparelProd/garmentCode/garmentCodeB/added/@addType) [Optional]  
- nota: *addType* allows the clarification of the meaning of the added element content; it is strongly suggested to use it always.

(XPath KnitClothOrder/KCCObody/KCCOitem/garTecSheet/garConsumptionSet/acsCode/added/@addType) [Optional]  
- nota: *addType* allows the clarification of the meaning of the added element content; it is strongly suggested to use it always.

(XPath KnitClothOrder/KCCObody/KCCOitem/garTecSheet/garConsumptionSet/garmentCode/garmentCodeB/added/@addType) [Optional]

	<p>- nota: <i>addType</i> allows the clarification of the meaning of the added element content; it is strongly suggested to use it always. (XPath KnitClothOrder/KCCObody/KCCOitem/garTecSheet/garConsumptionSet/yarnCode/added/@addType) [Optional]</p> <p>- nota: <i>addType</i> allows the clarification of the meaning of the added element content; it is strongly suggested to use it always. (XPath KnitClothOrder/KCCObody/KCCOitem/phase/garConsumptionSet/texCode/added/@addType) [Optional]</p> <p>- nota: <i>addType</i> allows the clarification of the meaning of the added element content; it is strongly suggested to use it always.</p>
appJob	<p>operation of a work cycle for garment manufacturing - base type: string, cod. table: T205 <a href="http://www.ebiz.enea.it/moda-ml/repository/codelist/draft/gc_T205.xml">http://www.ebiz.enea.it/moda-ml/repository/codelist/draft/gc_T205.xml</a> (XPath KnitClothOrder/KCCObody/KCCOitem/appMnfrOperation/appJob) 1-1</p>
appJobTech	<p>operation technology for garment production - base type: string, cod. table: T265 <a href="http://www.ebiz.enea.it/moda-ml/repository/codelist/draft/gc_T265.xml">http://www.ebiz.enea.it/moda-ml/repository/codelist/draft/gc_T265.xml</a> (XPath KnitClothOrder/KCCObody/KCCOitem/appMnfrOperation/appJobTech) 0-1</p>
@application	<p>force or similar condition (e.g. no. of revolutions) applied in a test as specified within the standard - base type: string, max length: 15, (XPath KnitClothOrder/KCCObody/KCCOitem/garTecSheet/garMeaSet/garMea/specValue/@application) [Optional]</p>
appMachine	<p>machine used in an operation of a work cycle for garment production - base type: string, cod. table: T275 <a href="http://www.ebiz.enea.it/moda-ml/repository/codelist/draft/gc_T275.xml">http://www.ebiz.enea.it/moda-ml/repository/codelist/draft/gc_T275.xml</a> (XPath KnitClothOrder/KCCObody/KCCOitem/appMnfrOperation/appMachine) 0-1</p>
art	<p>article number of the product - base type: string, max length: 80, (XPath KnitClothOrder/KCCObody/KCCOitem/apparelComponent/acsComponent/acsCode/art) 1-1 (XPath KnitClothOrder/KCCObody/KCCOitem/phase/garConsumptionSet/acsCode/art) 1-1 (XPath KnitClothOrder/KCCObody/KCCOitem/garTecSheet/garmentCode/garmentCodeA/art) 1-1 (XPath KnitClothOrder/KCCObody/KCCOitem/garTecSheet/garConsumptionSet/garmentCode/garmentCodeA/art) 1-1 (XPath KnitClothOrder/KCCObody/KCCOitem/garTecSheet/garConsumptionSet/yarnCode/art) 1-1 (XPath KnitClothOrder/KCCObody/KCCOitem/phase/garConsumptionSet/texCode/art) 1-1 - note: <i>can be used either for the base-article (excluding pattern/colour) or for the SKU</i> (XPath KnitClothOrder/KCCObody/KCCOitem/phase/garConsumptionSet/yarnCode/art) 1-1 (XPath KnitClothOrder/KCCObody/KCCOitem/apparelProd/garmentCode/garmentCodeA/art) 1-1 (XPath KnitClothOrder/KCCObody/KCCOitem/garTecSheet/garConsumptionSet/acsCode/art) 1-1 (XPath KnitClothOrder/KCCObody/KCCOitem/phase/garConsumptionSet/garmentCode/garmentCodeA/art) 1-1 (XPath KnitClothOrder/KCCObody/KCCOitem/garTecSheet/garConsumptionSet/texCode/art) 1-1 - note: <i>can be used either for the base-article (excluding pattern/colour) or for the SKU</i> (XPath KnitClothOrder/KCCObody/KCCOitem/apparelComponent/fabricComponent/texCode/art) 1-1</p>

	<p>- note: <i>can be used either for the base-article (excluding pattern/colour) or for the SKU</i></p> <p>(XPath KnitClothOrder/KCCObody/KCCOitem/apparelComponent/yarnComponent/yarnCode/art) 1-1</p>
artGroup	<p>code identifying a class of products</p> <p>- base type: string, max length: 40,</p> <p>(XPath KnitClothOrder/KCCObody/KCCOitem/garTecSheet/garConsumptionSet/garmentCode/garmentCodeB/artGroup) 0-1</p> <p>(XPath KnitClothOrder/KCCObody/KCCOitem/phase/garConsumptionSet/garmentCode/garmentCodeB/artGroup) 0-1</p> <p>(XPath KnitClothOrder/KCCObody/KCCOitem/garTecSheet/garmentCode/garmentCodeB/artGroup) 0-1</p> <p>(XPath KnitClothOrder/KCCObody/KCCOitem/apparelProd/garmentCode/garmentCodeB/artGroup) 0-1</p>
binaryObject	<p>a binary large object containing an attached document</p> <p>- base type: base64Binary,</p> <p>(XPath KnitClothOrder/KCCObody/KCCOitem/apparelComponent/fabricComponent/refDoc/attachment/binaryObject) 0-1</p> <p>(XPath KnitClothOrder/KCCOheader/refDoc/attachment/binaryObject) 0-1</p> <p>(XPath KnitClothOrder/KCCObody/KCCOitem/apparelComponent/garmentPartComponent/refDoc/attachment/binaryObject) 0-1</p> <p>(XPath KnitClothOrder/KCCObody/KCCOitem/garTecSheet/refDoc/attachment/binaryObject) 0-1</p> <p>(XPath KnitClothOrder/KCCObody/KCCOitem/apparelComponent/yarnComponent/refDoc/attachment/binaryObject) 0-1</p> <p>(XPath KnitClothOrder/KCCObody/KCCOitem/appMnfrOperation/refDoc/attachment/binaryObject) 0-1</p> <p>(XPath KnitClothOrder/KCCObody/KCCOitem/phase/refDoc/attachment/binaryObject) 0-1</p> <p>(XPath KnitClothOrder/KCCObody/KCCOitem/apparelComponent/acsComponent/refDoc/attachment/binaryObject) 0-1</p>
brand	<p>A brand name.</p> <p>- base type: string,</p> <p>(XPath KnitClothOrder/garComInfo/brand) 0-1</p> <p>(XPath KnitClothOrder/KCCObody/KCCOitem/garComInfo/brand) 0-1</p>
carrier	<p>identification of the transport carrier</p> <p>- base type: string, max length: 40,</p> <p>(XPath KnitClothOrder/terms/transInfo/carrier) 0-1</p>
@characterSet	<p>the character set of the binary object if the mime type is text</p> <p>- base type: normalizedString,</p> <p>(XPath KnitClothOrder/KCCOheader/refDoc/attachment/binaryObject/@characterSet) [Optional]</p> <p>(XPath KnitClothOrder/KCCObody/KCCOitem/garTecSheet/refDoc/attachment/binaryObject/@characterSet) [Optional]</p> <p>(XPath KnitClothOrder/KCCObody/KCCOitem/apparelComponent/acsComponent/refDoc/attachment/binaryObject/@characterSet) [Optional]</p> <p>(XPath KnitClothOrder/KCCObody/KCCOitem/appMnfrOperation/refDoc/attachment/binaryObject/@characterSet) [Optional]</p> <p>(XPath KnitClothOrder/KCCObody/KCCOitem/phase/refDoc/attachment/binaryObject/@characterSet) [Optional]</p> <p>(XPath KnitClothOrder/KCCObody/KCCOitem/apparelComponent/garmentPartComponent/refDoc/attachment/binaryObject/@characterSet) [Optional]</p> <p>(XPath KnitClothOrder/KCCObody/KCCOitem/apparelComponent/fabricComponent/refDoc/attachment/binaryObject/@characterSet) [Optional]</p> <p>(XPath KnitClothOrder/KCCObody/KCCOitem/apparelComponent/yarnComponent/refDoc/attachment/binaryObject/@characterSet) [Optional]</p>
characterSetCode	<p>the character set of an external document</p> <p>- base type: normalizedString,</p>



	<p>(XPath KnitClothOrder/KCCObody/KCCOitem/apparelComponent/fabricComponent/refDoc/attachment/externalReference/characterSetCode) 0-1</p> <p>(XPath KnitClothOrder/KCCObody/KCCOitem/phase/refDoc/attachment/externalReference/characterSetCode) 0-1</p> <p>(XPath KnitClothOrder/KCCObody/KCCOitem/apparelComponent/acsComponent/refDoc/attachment/externalReference/characterSetCode) 0-1</p> <p>(XPath KnitClothOrder/KCCOheader/refDoc/attachment/externalReference/characterSetCode) 0-1</p> <p>(XPath KnitClothOrder/KCCObody/KCCOitem/apparelComponent/yarnComponent/refDoc/attachment/externalReference/characterSetCode) 0-1</p> <p>(XPath KnitClothOrder/KCCObody/KCCOitem/garTecSheet/refDoc/attachment/externalReference/characterSetCode) 0-1</p> <p>(XPath KnitClothOrder/KCCObody/KCCOitem/appMnfrOperation/refDoc/attachment/externalReference/characterSetCode) 0-1</p> <p>(XPath KnitClothOrder/KCCObody/KCCOitem/apparelComponent/garmentPartComponent/refDoc/attachment/externalReference/characterSetCode) 0-1</p>
city	<p>name of the city (town, village)</p> <p>- base type: string, max length: 40,</p> <p>(XPath KnitClothOrder/KCCObody/KCCOitem/phase/thirdParty/city) 0-1</p> <p>(XPath KnitClothOrder/KCCObody/KCCOitem/thirdParty/city) 0-1</p> <p>(XPath KnitClothOrder/KCCOheader/subContractor/city) 0-1</p> <p>(XPath KnitClothOrder/KCCOheader/buyer/city) 0-1</p> <p>(XPath KnitClothOrder/KCCOheader/thirdParty/city) 0-1</p>
@codeList	<p>it specifies the URL where the list of codes used to make an instance of the element can be found</p> <p>- base type: string, max length: 255,</p> <p>(XPath KnitClothOrder/KCCObody/KCCOitem/phase/garConsumptionSet/garmentCode/garmentCodeB/garmentVariant/variantType/@codeList) [Optional]</p> <p>- nota: <i>this attribute should be ALTERNATIVE to the others</i></p> <p>(XPath KnitClothOrder/KCCObody/KCCOitem/apparelProd/note/@codeList) [Optional]</p> <p>- nota: <i>must be used to provide (URL) the list of codes used in "noteLabel"</i></p> <p>(XPath KnitClothOrder/KCCObody/KCCOitem/phase/garConsumptionSet/garmentCode/garmentCodeB/garmentVariant/variantCode/@codeList) [Optional]</p> <p>- nota: <i>this attribute should be ALTERNATIVE to the others</i></p> <p>(XPath KnitClothOrder/KCCObody/KCCOitem/appMnfrOperation/note/@codeList) [Optional]</p> <p>- nota: <i>must be used to provide (URL) the list of codes used in "noteLabel"</i></p> <p>(XPath KnitClothOrder/KCCObody/KCCOitem/apparelProd/csRange/sizeMatrix/sizeRow/itemsList/qualityLevel/@codeList) [Optional]</p> <p>(XPath KnitClothOrder/KCCObody/KCCOitem/garTecSheet/garMeaSet/garMea/size/@codeList) [Optional]</p> <p>(XPath KnitClothOrder/KCCObody/KCCOitem/endUseGroup/csRange/drop/@codeList) [Optional]</p> <p>(XPath KnitClothOrder/KCCObody/KCCOitem/garTecSheet/garmentCode/garmentCodeB/artGroup/@codeList) [Optional]</p> <p>- nota: <i>this attribute should be ALTERNATIVE to the others</i></p> <p>(XPath KnitClothOrder/KCCObody/KCCOitem/phase/garConsumptionSet/garmentCode/garmentCodeB/artGroup/@codeList) [Optional]</p> <p>- nota: <i>this attribute should be ALTERNATIVE to the others</i></p> <p>(XPath KnitClothOrder/KCCObody/KCCOitem/garTecSheet/garmentCode/garmentCodeA/art/@codeList) [Optional]</p> <p>- nota: <i>this attribute should be ALTERNATIVE to the others</i></p> <p>(XPath KnitClothOrder/KCCObody/KCCOitem/apparelComponent/garmentPartComponent/garmentPartCode/mod/@codeList) [Optional]</p> <p>- nota: <i>this attribute should be ALTERNATIVE to the others</i></p> <p>(XPath KnitClothOrder/KCCObody/KCCOitem/appMnfrOperation/refDoc/season/@codeList) [Optional]</p>

	<p>(XPath KnitClothOrder/KCCObody/KCCOitem/garTecSheet/ garmentCode/garmentCodeB/garmentVariant/variantCode/@codeList) [Optional]</p> <p>- nota: <i>this attribute should be ALTERNATIVE to the others</i></p> <p>(XPath KnitClothOrder/KCCObody/KCCOitem/garTecSheet/ garmentCode/garmentCodeB/drop/@codeList) [Optional]</p> <p>(XPath KnitClothOrder/KCCObody/KCCOitem/garTecSheet/ garmentCode/garmentCodeB/garmentVariant/variantType/@codeList) [Optional]</p> <p>- nota: <i>this attribute should be ALTERNATIVE to the others</i></p> <p>(XPath KnitClothOrder/KCCObody/KCCOitem/garTecSheet/ garmentCode/garmentCodeB/size/@codeList) [Optional]</p> <p>(XPath KnitClothOrder/KCCObody/KCCOitem/garTecSheet/ garmentCode/garmentCodeB/color/@codeList) [Optional]</p> <p>- nota: <i>this attribute could be used as alternative to the others</i></p> <p>(XPath KnitClothOrder/KCCObody/KCCOitem/garComInfo/ operationalCode/@codeList) [Optional]</p> <p>(XPath KnitClothOrder/KCCObody/KCCOitem/phase/garConsumptionSet/garmentCode/garmentCodeA/art/@codeList) [Optional]</p> <p>- nota: <i>this attribute should be ALTERNATIVE to the others</i></p> <p>(XPath KnitClothOrder/KCCObody/KCCOitem/phase/garConsumptionSet/garmentCode/garmentCodeB/drop/@codeList) [Optional]</p> <p>(XPath KnitClothOrder/KCCObody/KCCOitem/apparelComponent/ acsComponent/note/@codeList) [Optional]</p> <p>- nota: <i>must be used to provide (URL) the list of codes used in "noteLabel"</i></p> <p>(XPath KnitClothOrder/KCCObody/KCCOitem/apparelComponent/ fabricComponent/note/@codeList) [Optional]</p> <p>- nota: <i>must be used to provide (URL) the list of codes used in "noteLabel"</i></p> <p>(XPath KnitClothOrder/KCCObody/KCCOitem/endUseGroup/ csRange/garmentVariant/variantType/@codeList) [Optional]</p> <p>- nota: <i>this attribute should be ALTERNATIVE to the others</i></p> <p>(XPath KnitClothOrder/KCCObody/KCCOitem/garTecSheet/ garmentCode/garmentCodeB/fabric/@codeList) [Optional]</p> <p>- nota: <i>this attribute should be ALTERNATIVE to the others</i></p> <p>(XPath KnitClothOrder/KCCObody/KCCOitem/garTecSheet/ garmentCode/garmentCodeB/mod/@codeList) [Optional]</p> <p>- nota: <i>this attribute should be ALTERNATIVE to the others</i></p> <p>(XPath KnitClothOrder/KCCObody/KCCOitem/garTecSheet/ refDoc/season/@codeList) [Optional]</p> <p>(XPath KnitClothOrder/KCCObody/KCCOitem/phase/garConsumptionSet/garmentCode/garmentCodeB/size/@codeList) [Optional]</p> <p>(XPath KnitClothOrder/KCCObody/KCCOitem/phase/garConsumptionSet/garmentCode/garmentCodeB/color/@codeList) [Optional]</p> <p>- nota: <i>this attribute could be used as alternative to the others</i></p> <p>(XPath KnitClothOrder/KCCObody/KCCOitem/endUseGroup/ csRange/sizeMatrix/sizeRow/itemsList/qualityLevel/@codeList) [Optional]</p> <p>(XPath KnitClothOrder/KCCObody/KCCOitem/phase/garConsumptionSet/garmentPartCode/mod/@codeList) [Optional]</p> <p>- nota: <i>this attribute should be ALTERNATIVE to the others</i></p> <p>(XPath KnitClothOrder/KCCObody/KCCOitem/apparelComponent/ garmentPartComponent/note/@codeList) [Optional]</p> <p>- nota: <i>must be used to provide (URL) the list of codes used in "noteLabel"</i></p> <p>(XPath KnitClothOrder/KCCObody/KCCOitem/endUseGroup/ csRange/garmentVariant/variantCode/@codeList) [Optional]</p> <p>- nota: <i>this attribute should be ALTERNATIVE to the others</i></p> <p>(XPath KnitClothOrder/KCCObody/KCCOitem/phase/garConsumptionSet/acsCode/art/@codeList) [Optional]</p> <p>- nota: <i>this attribute should be ALTERNATIVE to the others</i></p> <p>(XPath KnitClothOrder/KCCObody/KCCOitem/progress/ itemsList/qualityLevel/@codeList) [Optional]</p>
--	---

(XPath KnitClothOrder/KCCObody/KCCOitem/apparelComponent/fabricComponent/texCode/color/@codeList) [Optional]  
- nota: *this attribute could be used as alternative to the others*

(XPath KnitClothOrder/KCCObody/KCCOitem/garTecSheet/garConsumptionSet/garmentCode/garmentCodeA/art/@codeList) [Optional]  
- nota: *this attribute should be ALTERNATIVE to the others*

(XPath KnitClothOrder/KCCObody/KCCOitem/garTecSheet/garConsumptionSet/garmentCode/garmentCodeB/drop/@codeList) [Optional]  
]

(XPath KnitClothOrder/KCCObody/KCCOitem/garTecSheet/garConsumptionSet/garmentCode/garmentCodeB/garmentVariant/variantCode/@codeList) [Optional]  
- nota: *this attribute should be ALTERNATIVE to the others*

(XPath KnitClothOrder/KCCObody/KCCOitem/apparelComponent/acsComponent/acsCode/pattern/@codeList) [Optional]  
- nota: *this attribute should be ALTERNATIVE to the others*

(XPath KnitClothOrder/KCCObody/KCCOitem/garTecSheet/garConsumptionSet/garmentCode/garmentCodeB/size/@codeList) [Optional]  
(XPath KnitClothOrder/KCCObody/KCCOitem/apparelComponent/acsComponent/acsCode/art/@codeList) [Optional]  
- nota: *this attribute should be ALTERNATIVE to the others*

(XPath KnitClothOrder/KCCObody/KCCOitem/garTecSheet/garConsumptionSet/garmentCode/garmentCodeB/artGroup/@codeList) [Optional]  
- nota: *this attribute should be ALTERNATIVE to the others*

(XPath KnitClothOrder/KCCObody/KCCOitem/phase/garConsumptionSet/garmentPartCode/fabric/@codeList) [Optional]  
- nota: *this attribute should be ALTERNATIVE to the others*

(XPath KnitClothOrder/KCCObody/KCCOitem/dtScheme/legalRef/@codeList) [Required]

(XPath KnitClothOrder/KCCObody/KCCOitem/apparelComponent/yarnComponent/note/@codeList) [Optional]  
- nota: *must be used to provide (URL) the list of codes used in "noteLabel"*

(XPath KnitClothOrder/KCCObody/KCCOitem/endUseGroup/csRange/sizeMatrix/sizeRow/additionalComponentCode/@codeList) [Optional]  
(XPath KnitClothOrder/KCCObody/KCCOitem/phase/garConsumptionSet/acsCode/pattern/@codeList) [Optional]  
- nota: *this attribute should be ALTERNATIVE to the others*

(XPath KnitClothOrder/KCCObody/KCCOitem/apparelComponent/garmentPartComponent/garmentPartCode/size/@codeList) [Optional]  
(XPath KnitClothOrder/KCCObody/KCCOitem/apparelComponent/fabricComponent/texCode/art/@codeList) [Optional]  
- nota: *this attribute should be ALTERNATIVE to the others*

(XPath KnitClothOrder/KCCObody/KCCOitem/phase/garConsumptionSet/texCode/color/@codeList) [Optional]  
- nota: *this attribute could be used as alternative to the others*

(XPath KnitClothOrder/KCCObody/KCCOitem/apparelComponent/fabricComponent/texCode/pattern/@codeList) [Optional]  
- nota: *this attribute should be ALTERNATIVE to the others*

(XPath KnitClothOrder/KCCObody/KCCOitem/apparelComponent/yarnComponent/refDoc/season/@codeList) [Optional]  
(XPath KnitClothOrder/KCCObody/KCCOitem/apparelComponent/yarnComponent/yarnCode/art/@codeList) [Optional]  
- nota: *this attribute should be ALTERNATIVE to the others*

(XPath KnitClothOrder/KCCObody/KCCOitem/endUseGroup/csRange/sizeMatrix/sizeRow/size/@codeList) [Optional]  
(XPath KnitClothOrder/KCCObody/KCCOitem/phase/garConsumptionSet/yarnCode/color/@codeList) [Optional]  
- nota: *this attribute could be used as alternative to the others*

(XPath KnitClothOrder/KCCObody/KCCOitem/apparelComponent/yarnComponent/yarnCode/color/@codeList) [Optional]

- nota: *this attribute could be used as alternative to the others*  
 (XPath KnitClothOrder/KCCObody/KCCOitem/endUseGroup/  
 csRange/sizeMatrix/sizeRow/drop/@codeList) [Optional]  
 (XPath KnitClothOrder/KCCObody/KCCOitem/phase/garConsumptionSet/yarnCode/  
 art/@codeList) [Optional]

- nota: *this attribute should be ALTERNATIVE to the others*  
 (XPath KnitClothOrder/KCCObody/KCCOitem/apparelComponent/  
 garmentPartComponent/refDoc/season/@codeList) [Optional]  
 (XPath KnitClothOrder/KCCObody/KCCOitem/phase/garConsumptionSet/garmentC  
 ode/garmentCodeB/mod/@codeList) [Optional]

- nota: *this attribute should be ALTERNATIVE to the others*  
 (XPath KnitClothOrder/KCCObody/KCCOitem/garTecSheet/  
 garConsumptionSet/texCode/color/@codeList) [Optional]

- nota: *this attribute could be used as alternative to the others*  
 (XPath KnitClothOrder/KCCObody/KCCOitem/garTecSheet/  
 garConsumptionSet/texCode/pattern/@codeList) [Optional]

- nota: *this attribute should be ALTERNATIVE to the others*  
 (XPath KnitClothOrder/KCCObody/KCCOitem/garTecSheet/  
 garConsumptionSet/yarnCode/art/@codeList) [Optional]

- nota: *this attribute should be ALTERNATIVE to the others*  
 (XPath KnitClothOrder/KCCObody/KCCOitem/apparelComponent/  
 garmentPartComponent/garmentPartCode/fabric/@codeList) [Optional]

- nota: *this attribute should be ALTERNATIVE to the others*  
 (XPath KnitClothOrder/KCCObody/KCCOitem/dtScheme/note/@codeList) [Optional]

- nota: *must be used to provide (URL) the list of codes used in "noteLabel"*  
 (XPath KnitClothOrder/KCCObody/KCCOitem/garTecSheet/  
 garConsumptionSet/yarnCode/color/@codeList) [Optional]

- nota: *this attribute could be used as alternative to the others*  
 (XPath KnitClothOrder/KCCObody/KCCOitem/apparelComponent/  
 acsComponent/refDoc/season/@codeList) [Optional]  
 (XPath KnitClothOrder/KCCObody/KCCOitem/garTecSheet/  
 garConsumptionSet/acsCode/pattern/@codeList) [Optional]

- nota: *this attribute should be ALTERNATIVE to the others*  
 (XPath KnitClothOrder/KCCObody/KCCOitem/garTecSheet/  
 garConsumptionSet/acsCode/art/@codeList) [Optional]

- nota: *this attribute should be ALTERNATIVE to the others*  
 (XPath KnitClothOrder/KCCObody/KCCOitem/apparelComponent/  
 fabricComponent/refDoc/season/@codeList) [Optional]  
 (XPath KnitClothOrder/KCCObody/KCCOitem/garTecSheet/  
 garConsumptionSet/acsCode/color/@codeList) [Optional]

- nota: *this attribute could be used as alternative to the others*  
 (XPath KnitClothOrder/KCCObody/KCCOitem/garTecSheet/  
 garConsumptionSet/texCode/art/@codeList) [Optional]

- nota: *this attribute should be ALTERNATIVE to the others*  
 (XPath KnitClothOrder/KCCObody/KCCOitem/phase/garConsumptionSet/garmentC  
 ode/garmentCodeB/fabric/@codeList) [Optional]

- nota: *this attribute should be ALTERNATIVE to the others*  
 (XPath KnitClothOrder/KCCObody/KCCOitem/phase/garConsumptionSet/acsCode/c  
 olor/@codeList) [Optional]

- nota: *this attribute could be used as alternative to the others*  
 (XPath KnitClothOrder/KCCOheader/season/@codeList) [Optional]  
 (XPath KnitClothOrder/KCCObody/KCCOitem/garTecSheet/  
 garConsumptionSet/garmentCode/garmentCodeB/mod/@codeList) [Optional  
 ]

- nota: *this attribute should be ALTERNATIVE to the others*  
 (XPath KnitClothOrder/KCCObody/KCCOitem/apparelComponent/  
 acsComponent/acsCode/color/@codeList) [Optional]

- nota: *this attribute could be used as alternative to the others*  
 (XPath KnitClothOrder/KCCObody/KCCOitem/apparelComponent/  
 garmentPartComponent/garmentPartCode/color/@codeList) [Optional]

- nota: *this attribute could be used as alternative to the others*

(XPath KnitClothOrder/KCCObody/KCCOitem/garTecSheet/garConsumptionSet/garmentCode/garmentCodeB/fabric/@codeList) [Optional]

- nota: *this attribute should be ALTERNATIVE to the others*

(XPath KnitClothOrder/KCCObody/KCCOitem/garTecSheet/garConsumptionSet/garmentCode/garmentCodeB/garmentVariant/variantType/@codeList) [Optional]

- nota: *this attribute should be ALTERNATIVE to the others*

(XPath KnitClothOrder/KCCObody/KCCOitem/garTecSheet/garConsumptionSet/garmentCode/garmentCodeB/color/@codeList) [Optional]

- nota: *this attribute could be used as alternative to the others*

(XPath KnitClothOrder/KCCObody/KCCOitem/phase/garConsumptionSet/garmentPartCode/color/@codeList) [Optional]

- nota: *this attribute could be used as alternative to the others*

(XPath KnitClothOrder/KCCObody/KCCOitem/phase/garConsumptionSet/texCode/pattern/@codeList) [Optional]

- nota: *this attribute should be ALTERNATIVE to the others*

(XPath KnitClothOrder/KCCObody/KCCOitem/apparelComponent/fabricComponent/itemsList/qualityLevel/@codeList) [Optional]

(XPath KnitClothOrder/KCCObody/KCCOitem/garTecSheet/garConsumptionSet/garmentPartCode/fabric/@codeList) [Optional]

- nota: *this attribute should be ALTERNATIVE to the others*

(XPath KnitClothOrder/KCCObody/KCCOitem/garTecSheet/garConsumptionSet/garmentPartCode/mod/@codeList) [Optional]

- nota: *this attribute should be ALTERNATIVE to the others*

(XPath KnitClothOrder/KCCObody/KCCOitem/phase/garConsumptionSet/texCode/art/@codeList) [Optional]

- nota: *this attribute should be ALTERNATIVE to the others*

(XPath KnitClothOrder/KCCObody/KCCOitem/garTecSheet/garConsumptionSet/garmentPartCode/size/@codeList) [Optional]

(XPath KnitClothOrder/KCCObody/KCCOitem/garTecSheet/garConsumptionSet/garmentPartCode/color/@codeList) [Optional]

- nota: *this attribute could be used as alternative to the others*

(XPath KnitClothOrder/KCCObody/KCCOitem/phase/garConsumptionSet/garmentPartCode/size/@codeList) [Optional]

(XPath KnitClothOrder/KCCObody/KCCOitem/phase/phaseCode/@codeList) [Optional]

(XPath KnitClothOrder/KCCObody/KCCOitem/apparelProd/garmentCode/garmentCodeB/mod/@codeList) [Optional]

- nota: *this attribute should be ALTERNATIVE to the others*

(XPath KnitClothOrder/garComInfo/productLine/@codeList) [Optional]

(XPath KnitClothOrder/KCCObody/KCCOitem/phase/lotDetails/csRange/sizeMatrix/sizeRow/itemsList/qualityLevel/@codeList) [Optional]

(XPath KnitClothOrder/KCCObody/KCCOitem/phase/packages/handlingChar/note/@codeList) [Optional]

- nota: *must be used to provide (URL) the list of codes used in "noteLabel"*

(XPath KnitClothOrder/KCCObody/KCCOitem/apparelProd/garmentCode/garmentCodeB/fabric/@codeList) [Optional]

- nota: *this attribute should be ALTERNATIVE to the others*

(XPath KnitClothOrder/KCCObody/KCCOitem/note/@codeList) [Optional]

- nota: *must be used to provide (URL) the list of codes used in "noteLabel"*

(XPath KnitClothOrder/KCCObody/KCCOitem/apparelProd/csRange/garmentVariant/variantType/@codeList) [Optional]

- nota: *this attribute should be ALTERNATIVE to the others*

(XPath KnitClothOrder/KCCObody/KCCOitem/phase/lotDetails/csRange/sizeMatrix/sizeRow/drop/@codeList) [Optional]

(XPath KnitClothOrder/KCCObody/KCCOitem/phase/lotDetails/csRange/sizeMatrix/sizeRow/size/@codeList) [Optional]

(XPath KnitClothOrder/KCCObody/KCCOitem/phase/lotDetails/csRange/garmentVariant/variantType/@codeList) [Optional]

- nota: *this attribute should be ALTERNATIVE to the others*

(XPath KnitClothOrder/KCCObody/KCCOitem/apparelProd/garmentCode/garmentCodeB/drop/@codeList) [Optional]

(XPath KnitClothOrder/terms/allowanceCharge/dtScheme/legalRef/@codeList) [Required]

(XPath KnitClothOrder/KCCObody/KCCOitem/apparelProd/garmentCode/garmentCodeB/garmentVariant/variantCode/@codeList) [Optional]

- nota: *this attribute should be ALTERNATIVE to the others*

(XPath KnitClothOrder/KCCObody/KCCOitem/phase/lotDetails/csRange/color/@codeList) [Optional]

- nota: *this attribute could be used as alternative to the others*

(XPath KnitClothOrder/KCCObody/KCCOitem/apparelProd/garmentCode/garmentCodeB/garmentVariant/variantType/@codeList) [Optional]

- nota: *this attribute should be ALTERNATIVE to the others*

(XPath KnitClothOrder/KCCObody/KCCOitem/garComInfo/note/@codeList) [Optional]

- nota: *must be used to provide (URL) the list of codes used in "noteLabel"*

(XPath KnitClothOrder/terms/allowanceCharge/dtScheme/note/@codeList) [Optional]

- nota: *must be used to provide (URL) the list of codes used in "noteLabel"*

(XPath KnitClothOrder/garComInfo/season/@codeList) [Optional]

(XPath KnitClothOrder/KCCOheader/note/@codeList) [Optional]

- nota: *must be used to provide (URL) the list of codes used in "noteLabel"*

(XPath KnitClothOrder/KCCObody/KCCOitem/apparelProd/csRange/sizeMatrix/sizeRow/additionalComponentCode/@codeList) [Optional]

(XPath KnitClothOrder/KCCObody/KCCOitem/apparelProd/garmentCode/garmentCodeB/color/@codeList) [Optional]

- nota: *this attribute could be used as alternative to the others*

(XPath KnitClothOrder/KCCObody/KCCOitem/apparelProd/csRange/drop/@codeList) [Optional]

(XPath KnitClothOrder/garComInfo/brand/@codeList) [Optional]

(XPath KnitClothOrder/KCCObody/KCCOitem/garComInfo/season/@codeList) [Optional]

(XPath KnitClothOrder/KCCObody/KCCOitem/apparelProd/garmentCode/garmentCodeB/artGroup/@codeList) [Optional]

- nota: *this attribute should be ALTERNATIVE to the others*

(XPath KnitClothOrder/KCCObody/KCCOitem/apparelProd/garmentPartCode/fabric/@codeList) [Optional]

- nota: *this attribute should be ALTERNATIVE to the others*

(XPath KnitClothOrder/KCCObody/KCCOitem/apparelProd/garmentPartCode/mod/@codeList) [Optional]

- nota: *this attribute should be ALTERNATIVE to the others*

(XPath KnitClothOrder/KCCObody/KCCOitem/packages/handlingChar/note/@codeList) [Optional]

- nota: *must be used to provide (URL) the list of codes used in "noteLabel"*

(XPath KnitClothOrder/KCCObody/KCCOitem/apparelProd/csRange/sizeMatrix/sizeRow/drop/@codeList) [Optional]

(XPath KnitClothOrder/KCCObody/KCCOitem/apparelProd/csRange/sizeMatrix/sizeRow/size/@codeList) [Optional]

(XPath KnitClothOrder/garComInfo/note/@codeList) [Optional]

- nota: *must be used to provide (URL) the list of codes used in "noteLabel"*

(XPath KnitClothOrder/KCCObody/KCCOitem/apparelProd/csRange/color/@codeList) [Optional]

- nota: *this attribute could be used as alternative to the others*

(XPath KnitClothOrder/KCCObody/KCCOitem/phase/lotDetails/csRange/drop/@codeList) [Optional]

(XPath KnitClothOrder/KCCObody/KCCOitem/phase/lotDetails/csRange/garmentVariant/variantCode/@codeList) [Optional]

- nota: *this attribute should be ALTERNATIVE to the others*

(XPath KnitClothOrder/KCCObody/KCCOitem/phase/lotDetails/csRange/sizeMatrix/sizeRow/additionalComponentCode/@codeList) [Optional]

(XPath KnitClothOrder/KCCObody/KCCOitem/phase/note/@codeList) [Optional]

- nota: *must be used to provide (URL) the list of codes used in "noteLabel"*

	<p>(XPath KnitClothOrder/garComInfo/operationalCode/@codeList) [Optional]  (XPath KnitClothOrder/KCCObody/KCCOitem/apparelProd/garmentPartCode/color/@codeList) [Optional]  - nota: <i>this attribute could be used as alternative to the others</i>  (XPath KnitClothOrder/KCCObody/KCCOitem/apparelProd/csRange/garmentVariant/variantCode/@codeList) [Optional]  - nota: <i>this attribute should be ALTERNATIVE to the others</i>  (XPath KnitClothOrder/KCCObody/KCCOitem/apparelProd/garmentCode/garmentCodeA/art/@codeList) [Optional]  - nota: <i>this attribute should be ALTERNATIVE to the others</i>  (XPath KnitClothOrder/KCCObody/KCCOitem/apparelProd/garmentPartCode/size/@codeList) [Optional]  (XPath KnitClothOrder/KCCObody/KCCOitem/phase/refDoc/season/@codeList) [Optional]  (XPath KnitClothOrder/KCCObody/KCCOitem/endUseGroup/csRange/color/@codeList) [Optional]  - nota: <i>this attribute could be used as alternative to the others</i>  (XPath KnitClothOrder/KCCOheader/refDoc/season/@codeList) [Optional]  (XPath KnitClothOrder/KCCObody/KCCOitem/garComInfo/productLine/@codeList) [Optional]  (XPath KnitClothOrder/KCCObody/KCCOitem/apparelProd/garmentCode/garmentCodeB/size/@codeList) [Optional]  (XPath KnitClothOrder/KCCObody/KCCOitem/garComInfo/brand/@codeList) [Optional]</p>
@codeQualifier	<p>operational code qualifier: it states if the code is related to a project, an event, an initiative, a sales channel, a management type (eg CITES), .....</p> <p>- base type: string, cod. table: NT43  <a href="http://www.ebiz.enea.it/moda-ml/repository/codelist/draft/gc_NT43.xml">http://www.ebiz.enea.it/moda-ml/repository/codelist/draft/gc_NT43.xml</a>  (XPath KnitClothOrder/KCCObody/KCCOitem/garComInfo/operationalCode/@codeQualifier) [Optional]  (XPath KnitClothOrder/garComInfo/operationalCode/@codeQualifier) [Optional]</p>
color	<p>colour number of the product, when not included in the model or fabric code</p> <p>- base type: string, max length: 15,  (XPath KnitClothOrder/KCCObody/KCCOitem/phase/lotDetails/csRange/color) 0-1</p> <p>- note: <i>used only if not already specified in the article code</i>  (XPath KnitClothOrder/KCCObody/KCCOitem/apparelComponent/fabricComponent/texCode/color) 0-1  (XPath KnitClothOrder/KCCObody/KCCOitem/apparelComponent/garmentPartComponent/garmentPartCode/color) 0-1</p> <p>- note: <i>when a garment component, it should be the code assigned to the garment article</i>  (XPath KnitClothOrder/KCCObody/KCCOitem/apparelProd/csRange/color) 0-1</p> <p>- note: <i>used only if not already specified in the article code</i>  (XPath KnitClothOrder/KCCObody/KCCOitem/endUseGroup/csRange/color) 0-1</p> <p>- note: <i>used only if not already specified in the article code</i>  (XPath KnitClothOrder/KCCObody/KCCOitem/phase/garConsumptionSet/acsCode/color) 0-1  (XPath KnitClothOrder/KCCObody/KCCOitem/phase/garConsumptionSet/texCode/color) 0-1  (XPath KnitClothOrder/KCCObody/KCCOitem/phase/garConsumptionSet/yarnCode/color) 0-1  (XPath KnitClothOrder/KCCObody/KCCOitem/garTecSheet/garConsumptionSet/garmentPartCode/color) 0-1</p> <p>- note: <i>when a garment component, it should be the code assigned to the garment article</i>  (XPath KnitClothOrder/KCCObody/KCCOitem/apparelComponent/yarnComponent/yarnCode/color) 0-1  (XPath KnitClothOrder/KCCObody/KCCOitem/apparelProd/garmentPartCode/color) 0-1</p>

	<p>- note: <i>when a garment component, it should be the code assigned to the garment article</i>  (XPath KnitClothOrder/KCCObody/KCCOitem/phase/garConsumptionSet/garmentPartCode/color) 0-1</p> <p>- note: <i>when a garment component, it should be the code assigned to the garment article</i>  (XPath KnitClothOrder/KCCObody/KCCOitem/garTecSheet/garConsumptionSet/garmentCode/garmentCodeB/color) 0-1  (XPath KnitClothOrder/KCCObody/KCCOitem/apparelComponent/acsComponent/acsCode/color) 0-1  (XPath KnitClothOrder/KCCObody/KCCOitem/garTecSheet/garConsumptionSet/acsCode/color) 0-1  (XPath KnitClothOrder/KCCObody/KCCOitem/phase/garConsumptionSet/garmentCode/garmentCodeB/color) 0-1  (XPath KnitClothOrder/KCCObody/KCCOitem/garTecSheet/garmentCode/garmentCodeB/color) 0-1  (XPath KnitClothOrder/KCCObody/KCCOitem/apparelProd/garmentCode/garmentCodeB/color) 0-1  (XPath KnitClothOrder/KCCObody/KCCOitem/garTecSheet/garConsumptionSet/yarnCode/color) 0-1  (XPath KnitClothOrder/KCCObody/KCCOitem/garTecSheet/garConsumptionSet/texCode/color) 0-1</p>
@consumptionType	<p>indicates what the indicated quantity is referred to (for example, required quantity for unit of product -BoM- or required quantity to obtain the indicated total amount of product -BoL-)  - base type: string, cod. table: NT39  <a href="http://www.ebiz.enea.it/moda-ml/repository/codelist/draft/gc_NT39.xml">http://www.ebiz.enea.it/moda-ml/repository/codelist/draft/gc_NT39.xml</a>  (XPath KnitClothOrder/KCCObody/KCCOitem/garTecSheet/garConsumptionSet/garConsumption/@consumptionType) [Optional]  (XPath KnitClothOrder/KCCObody/KCCOitem/phase/garConsumptionSet/garConsumption/@consumptionType) [Optional]</p>
country	<p>code of the nation  - base type: string, cod. table: T10  <a href="http://www.ebiz.enea.it/moda-ml/repository/codelist/draft/gc_T10.xml">http://www.ebiz.enea.it/moda-ml/repository/codelist/draft/gc_T10.xml</a>  (XPath KnitClothOrder/KCCObody/KCCOitem/phase/thirdParty/country) 0-1  (XPath KnitClothOrder/KCCOheader/subContractor/country) 0-1  (XPath KnitClothOrder/KCCOheader/buyer/country) 0-1  (XPath KnitClothOrder/KCCObody/KCCOitem/thirdParty/country) 0-1  (XPath KnitClothOrder/KCCOheader/thirdParty/country) 0-1</p>
@CQQ	<p>specifies if the committed quantity can or can not include the loss in weight  - base type: string, cod. table: NT37  <a href="http://www.ebiz.enea.it/moda-ml/repository/codelist/draft/gc_NT37.xml">http://www.ebiz.enea.it/moda-ml/repository/codelist/draft/gc_NT37.xml</a>  (XPath KnitClothOrder/KCCObody/KCCOitem/apparelComponent/yarnComponent/@CQQ) [Optional]</p>
criticalityIndicator	<p>criticality indicator (it can be "true" or "false": true = criticality, false = non criticality)  - base type: boolean,  (XPath KnitClothOrder/KCCObody/KCCOitem/phase/criticalityIndicator) 0-1</p>
@currency	<p>currency in which a specified monetary data is expressed  - base type: string, cod. table: T9  <a href="http://www.ebiz.enea.it/moda-ml/repository/codelist/draft/gc_T9.xml">http://www.ebiz.enea.it/moda-ml/repository/codelist/draft/gc_T9.xml</a>  (XPath KnitClothOrder/KCCObody/KCCOitem/price/@currency) [Optional]  - nota: <i>Currency referred by the price.</i>  (XPath KnitClothOrder/terms/allowanceCharge/@currency) [Optional]  (XPath KnitClothOrder/KCCObody/KCCOitem/phase/price/@currency) [Optional]  - nota: <i>Currency referred by the price.</i></p>
customsStat	<p>statistic code assigned by Customs to a specified product  - base type: string, max length: 15,</p>



	(XPath KnitClothOrder/KCCObody/KCCOitem/garTecSheet/customsStat) 0-1
@CV	coefficient of variation (CV) of a measurement - base type: decimal, (XPath KnitClothOrder/KCCObody/KCCOitem/garTecSheet/ garMeaSet/garMea/specValue/@CV) [Optional]
@dateForm	format used for the date - base type: string, cod. table: NT29 <a href="http://www.ebiz.enea.it/moda-ml/repository/codelist/draft/gc_NT29.xml">http://www.ebiz.enea.it/moda-ml/repository/codelist/draft/gc_NT29.xml</a> (XPath KnitClothOrder/KCCObody/KCCOitem/phase/refDoc/ docDate/@dateForm) [Optional] (XPath KnitClothOrder/KCCObody/KCCOitem/apparelComponent/ garmentPartComponent/refDoc/docDate/@dateForm) [Optional] (XPath KnitClothOrder/KCCObody/KCCOitem/apparelComponent/ yarnComponent/refDoc/docDate/@dateForm) [Optional] (XPath KnitClothOrder/terms/transInfo/despatchDate/@dateForm) [Optional] (XPath KnitClothOrder/KCCObody/KCCOitem/apparelComponent/ fabricComponent/refDoc/docDate/@dateForm) [Optional] (XPath KnitClothOrder/KCCOheader/refDoc/docDate/@dateForm) [Optional] (XPath KnitClothOrder/KCCOheader/msgDate/@dateForm) [Optional] (XPath KnitClothOrder/KCCObody/KCCOitem/apparelComponent/ acsComponent/refDoc/docDate/@dateForm) [Optional] (XPath KnitClothOrder/KCCOheader/validityStart/@dateForm) [Optional] (XPath KnitClothOrder/KCCObody/KCCOitem/phase/deliveryDate/@dateForm) [Opti onal] (XPath KnitClothOrder/garComInfo/specDate/@dateForm) [Optional] (XPath KnitClothOrder/KCCObody/KCCOitem/phase/notBeforeDate/@dateForm) [O ptional] (XPath KnitClothOrder/KCCObody/KCCOitem/progress/ deliveryDate/@dateForm) [Optional] (XPath KnitClothOrder/KCCObody/KCCOitem/progress/ delGrantedDate/@dateForm) [Optional] (XPath KnitClothOrder/KCCObody/KCCOitem/garComInfo/ deliveryDate/@dateForm) [Optional] (XPath KnitClothOrder/KCCOheader/validityEnd/@dateForm) [Optional] (XPath KnitClothOrder/KCCObody/KCCOitem/garComInfo/ specDate/@dateForm) [Optional] (XPath KnitClothOrder/garComInfo/deliveryDate/@dateForm) [Optional] (XPath KnitClothOrder/KCCObody/KCCOitem/deliveryDate/@dateForm) [Optional] (XPath KnitClothOrder/KCCObody/KCCOitem/phase/delGrantedDate/@dateForm) [ Optional] (XPath KnitClothOrder/terms/transInfo/delEffectiveDate/@dateForm) [Optional] (XPath KnitClothOrder/KCCObody/KCCOitem/appMnfrOperation/ refDoc/docDate/@dateForm) [Optional] (XPath KnitClothOrder/KCCObody/KCCOitem/garTecSheet/ refDoc/docDate/@dateForm) [Optional]
delEffectiveDate	effective date of delivery of goods (declared in Despatch), according to one of the patterns YYYY-MM-DD, YYYY-MM-DD:HH-MM or YYYY-WW. - base type: string, (XPath KnitClothOrder/terms/transInfo/delEffectiveDate) 0-1
delGrantedDate	effective granted date of delivery of goods; in case of doubt delivery must be understood as the event when the ownership of goods is transferred, according to one of the patterns YYYY-MM-DD, YYYY-MM-DD:HH-MM or YYYY-WW. - base type: string, (XPath KnitClothOrder/KCCObody/KCCOitem/phase/delGrantedDate) 0-1 (XPath KnitClothOrder/KCCObody/KCCOitem/progress/delGrantedDate) 0-1
deliveryDate	date of delivery of goods, requested or promised in the purchase process, according to one of the patterns YYYY-MM-DD, YYYY-MM-DD:HH-MM or YY

	<p>YY-WW.</p> <ul style="list-style-type: none"> <li>- base type: string,</li> <li>(XPath KnitClothOrder/garComInfo/deliveryDate) 0-1</li> <li>(XPath KnitClothOrder/KCCObody/KCCOitem/deliveryDate) 0-1</li> <li>- note: <i>Delivery date should not be used here when the garComInfo.element is used.</i></li> <li>(XPath KnitClothOrder/KCCObody/KCCOitem/phase/deliveryDate) 0-1</li> <li>(XPath KnitClothOrder/KCCObody/KCCOitem/garComInfo/deliveryDate) 0-1</li> <li>(XPath KnitClothOrder/KCCObody/KCCOitem/progress/deliveryDate) 0-1</li> </ul>
deliveryPlace	<p>place of delivery of goods, ultimate or related to a given leg</p> <ul style="list-style-type: none"> <li>- base type: string, max length: 250,</li> <li>(XPath KnitClothOrder/terms/transInfo/deliveryPlace) 0-1</li> </ul>
dept	<p>name or code of a contact department within a Party</p> <ul style="list-style-type: none"> <li>- base type: string, max length: 40,</li> <li>(XPath KnitClothOrder/KCCOheader/buyer/dept) 0-1</li> <li>(XPath KnitClothOrder/KCCObody/KCCOitem/phase/thirdParty/dept) 0-1</li> <li>(XPath KnitClothOrder/KCCOheader/subContractor/dept) 0-1</li> <li>(XPath KnitClothOrder/KCCObody/KCCOitem/thirdParty/dept) 0-1</li> <li>(XPath KnitClothOrder/KCCOheader/thirdParty/dept) 0-1</li> </ul>
description	<p>free text description. The content of the element must be unique, it might be translated and repeated into more languages (thus no more than one instance for each language).</p> <ul style="list-style-type: none"> <li>- base type: string, max length: 250,</li> <li>(XPath KnitClothOrder/KCCObody/KCCOitem/phase/garConsumptionSet/yarnCode/description) 0-unbounded</li> <li>- note: <i>Product description</i></li> <li>(XPath KnitClothOrder/KCCObody/KCCOitem/phase/garConsumptionSet/garmentCode/garmentCodeB/description) 0-unbounded</li> <li>- note: <i>Product description</i></li> <li>(XPath KnitClothOrder/KCCObody/KCCOitem/phase/garConsumptionSet/texCode/description) 0-unbounded</li> <li>- note: <i>Product description</i></li> <li>(XPath KnitClothOrder/KCCObody/KCCOitem/apparelProd/garmentCode/garmentCodeB/description) 0-unbounded</li> <li>- note: <i>Product description</i></li> <li>(XPath KnitClothOrder/KCCObody/KCCOitem/apparelComponent/garmentPartComponent/garmentPartCode/description) 0-unbounded</li> <li>- note: <i>Product part description</i></li> <li>(XPath KnitClothOrder/KCCObody/KCCOitem/garTecSheet/garConsumptionSet/texCode/description) 0-unbounded</li> <li>- note: <i>Product description</i></li> <li>(XPath KnitClothOrder/KCCObody/KCCOitem/garTecSheet/garConsumptionSet/acsCode/description) 0-unbounded</li> <li>- note: <i>Product description</i></li> <li>(XPath KnitClothOrder/KCCObody/KCCOitem/garTecSheet/garConsumptionSet/garmentCode/garmentCodeB/description) 0-unbounded</li> <li>- note: <i>Product description</i></li> <li>(XPath KnitClothOrder/KCCObody/KCCOitem/garTecSheet/garmentCode/garmentCodeA/description) 0-unbounded</li> <li>- note: <i>Product description</i></li> <li>(XPath KnitClothOrder/KCCObody/KCCOitem/phase/garConsumptionSet/acsCode/description) 0-unbounded</li> <li>- note: <i>Product description</i></li> <li>(XPath KnitClothOrder/KCCObody/KCCOitem/phase/packages/description) 0-unbounded</li> <li>(XPath KnitClothOrder/KCCObody/KCCOitem/phase/garConsumptionSet/garmentPartCode/description) 0-unbounded</li> <li>- note: <i>Product part description</i></li> </ul>

	<p>(XPath KnitClothOrder/KCCObody/KCCOitem/apparelProd/garmentPartCode/description) 0-unbounded - note: <i>Product part description</i></p> <p>(XPath KnitClothOrder/KCCObody/KCCOitem/apparelProd/garmentCode/garmentCodeA/description) 0-unbounded - note: <i>Product description</i></p> <p>(XPath KnitClothOrder/KCCObody/KCCOitem/garTecSheet/garConsumptionSet/garmentPartCode/description) 0-unbounded - note: <i>Product part description</i></p> <p>(XPath KnitClothOrder/KCCObody/KCCOitem/garTecSheet/garmentCode/garmentCodeB/description) 0-unbounded - note: <i>Product description</i></p> <p>(XPath KnitClothOrder/KCCObody/KCCOitem/apparelComponent/acsComponent/acsCode/description) 0-unbounded - note: <i>Product description</i></p> <p>(XPath KnitClothOrder/KCCObody/KCCOitem/apparelComponent/yarnComponent/yarnCode/description) 0-unbounded - note: <i>Product description</i></p> <p>(XPath KnitClothOrder/KCCObody/KCCOitem/packages/description) 0-unbounded (XPath KnitClothOrder/KCCObody/KCCOitem/garTecSheet/garConsumptionSet/yarnCode/description) 0-unbounded - note: <i>Product description</i></p> <p>(XPath KnitClothOrder/KCCObody/KCCOitem/apparelComponent/fabricComponent/texCode/description) 0-unbounded - note: <i>Product description</i></p> <p>(XPath KnitClothOrder/KCCObody/KCCOitem/garTecSheet/garConsumptionSet/garmentCode/garmentCodeA/description) 0-unbounded - note: <i>Product description</i></p> <p>(XPath KnitClothOrder/KCCObody/KCCOitem/phase/garConsumptionSet/garmentCode/garmentCodeA/description) 0-unbounded - note: <i>Product description</i></p>
despatchDate	<p>date of despatch of goods, requested or promised in the purchase process, according to one of the patterns YYYY-MM-DD, YYYY-MM-DD:HH-MM or YYYY-WW. - base type: string, (XPath KnitClothOrder/terms/transInfo/despatchDate) 0-1</p>
despatchPlace	<p>place of despatch of goods, origin or related to a given leg - base type: string, max length: 250, (XPath KnitClothOrder/terms/transInfo/despatchPlace) 0-1</p>
docDate	<p>date of issue of the referenced document, according to one of the patterns YYYY-MM-DD, YYYY-MM-DD:HH-MM or YYYY-WW. - base type: string, (XPath KnitClothOrder/KCCObody/KCCOitem/phase/refDoc/docDate) 0-1 (XPath KnitClothOrder/KCCOheader/refDoc/docDate) 0-1 (XPath KnitClothOrder/KCCObody/KCCOitem/apparelComponent/fabricComponent/refDoc/docDate) 0-1 (XPath KnitClothOrder/KCCObody/KCCOitem/appMnfrOperation/refDoc/docDate) 0-1 (XPath KnitClothOrder/KCCObody/KCCOitem/apparelComponent/acsComponent/refDoc/docDate) 0-1 (XPath KnitClothOrder/KCCObody/KCCOitem/apparelComponent/garmentPartComponent/refDoc/docDate) 0-1 (XPath KnitClothOrder/KCCObody/KCCOitem/garTecSheet/refDoc/docDate) 0-1 (XPath KnitClothOrder/KCCObody/KCCOitem/apparelComponent/yarnComponent/refDoc/docDate) 0-1</p>
docID	<p>identification number of the referenced document SINCE 2008-1 ITS USE IN THE HEADER IS DISCOURAGED (REPLACED BY msgID) - base type: string, max length: 80, (XPath KnitClothOrder/KCCObody/KCCOitem/apparelComponent/yarnComponent/refDoc/docID) 1-2</p>

	<p>(XPath KnitClothOrder/KCCObody/KCCOitem/apparelComponent/acsComponent/refDoc/docID) 1-2</p> <p>(XPath KnitClothOrder/KCCObody/KCCOitem/appMnfrOperation/refDoc/docID) 1-2</p> <p>(XPath KnitClothOrder/KCCOheader/docID) 0-1</p> <p>(XPath KnitClothOrder/KCCObody/KCCOitem/apparelComponent/garmentPartComponent/refDoc/docID) 1-2</p> <p>(XPath KnitClothOrder/KCCObody/KCCOitem/garTecSheet/refDoc/docID) 1-2</p> <p>(XPath KnitClothOrder/KCCObody/KCCOitem/apparelComponent/fabricComponent/refDoc/docID) 1-2</p> <p>(XPath KnitClothOrder/KCCObody/KCCOitem/phase/refDoc/docID) 1-2</p> <p>(XPath KnitClothOrder/KCCOheader/refDoc/docID) 1-2</p>
@docType	<p>type or class to which the referenced document belongs</p> <p>- base type: string, cod. table: T21</p> <p><a href="http://www.ebiz.enea.it/moda-ml/repository/codelist/draft/gc_T21.xml">http://www.ebiz.enea.it/moda-ml/repository/codelist/draft/gc_T21.xml</a></p> <p>(XPath KnitClothOrder/KCCObody/KCCOitem/garTecSheet/refDoc/@docType) [Required]</p> <p>(XPath KnitClothOrder/KCCObody/KCCOitem/apparelComponent/yarnComponent/refDoc/@docType) [Required]</p> <p>(XPath KnitClothOrder/KCCObody/KCCOitem/apparelComponent/garmentPartComponent/refDoc/@docType) [Required]</p> <p>(XPath KnitClothOrder/KCCObody/KCCOitem/phase/refDoc/@docType) [Required]</p> <p>(XPath KnitClothOrder/KCCObody/KCCOitem/apparelComponent/fabricComponent/refDoc/@docType) [Required]</p> <p>(XPath KnitClothOrder/KCCObody/KCCOitem/apparelComponent/acsComponent/refDoc/@docType) [Required]</p> <p>(XPath KnitClothOrder/KCCObody/KCCOitem/appMnfrOperation/refDoc/@docType) [Required]</p> <p>(XPath KnitClothOrder/KCCOheader/refDoc/@docType) [Required]</p>
drop	<p>drop number of the garment</p> <p>- base type: string, max length: 15,</p> <p>(XPath KnitClothOrder/KCCObody/KCCOitem/endUseGroup/csRange/drop) 0-1</p> <p>- note: <i>used only if not already specified in the article code</i></p> <p>(XPath KnitClothOrder/KCCObody/KCCOitem/garTecSheet/garConsumptionSet/garmentCode/garmentCodeB/drop) 0-1</p> <p>- note: <i>Fill this element if the drop is the same for all the sizes of the model. Otherway specify it within the csRange element</i></p> <p>(XPath KnitClothOrder/KCCObody/KCCOitem/endUseGroup/csRange/sizeMatrix/sizeRow/drop) 0-1</p> <p>- note: <i>DEPRECATED, anyhow it is used only if not already specified in the article code or csRange</i></p> <p>(XPath KnitClothOrder/KCCObody/KCCOitem/phase/lotDetails/csRange/sizeMatrix/sizeRow/drop) 0-1</p> <p>- note: <i>DEPRECATED, anyhow it is used only if not already specified in the article code or csRange</i></p> <p>(XPath KnitClothOrder/KCCObody/KCCOitem/apparelProd/csRange/drop) 0-1</p> <p>- note: <i>used only if not already specified in the article code</i></p> <p>(XPath KnitClothOrder/KCCObody/KCCOitem/phase/lotDetails/csRange/drop) 0-1</p> <p>- note: <i>used only if not already specified in the article code</i></p> <p>(XPath KnitClothOrder/KCCObody/KCCOitem/apparelProd/garmentCode/garmentCodeB/drop) 0-1</p> <p>- note: <i>Fill this element if the drop is the same for all the sizes of the model. Otherway specify it within the csRange element</i></p> <p>(XPath KnitClothOrder/KCCObody/KCCOitem/phase/garConsumptionSet/garmentCode/garmentCodeB/drop) 0-1</p> <p>- note: <i>Fill this element if the drop is the same for all the sizes of the model. Otherway specify it within the csRange element</i></p> <p>(XPath KnitClothOrder/KCCObody/KCCOitem/apparelProd/csRange/sizeMatrix/sizeRow/drop) 0-1</p>

	<p>- note: <i>DEPRECATED</i>, anyhow it is used only if not already specified in the article code or csRange  (XPath KnitClothOrder/KCCObody/KCCOitem/garTecSheet/garmentCode/garmentCodeB/drop) 0-1</p> <p>- note: <i>Fill this element if the drop is the same for all the sizes of the model. Otherway specify it within the csRange element</i></p>
dyeN	<p>number of the dying batch of a textile product</p> <p>- base type: string, max length: 15,  (XPath KnitClothOrder/KCCObody/KCCOitem/garTecSheet/garConsumptionSet/dyeN) 0-99  (XPath KnitClothOrder/KCCObody/KCCOitem/apparelComponent/acsComponent/dyeN) 0-1  (XPath KnitClothOrder/KCCObody/KCCOitem/apparelComponent/yarnComponent/dyeN) 0-1  (XPath KnitClothOrder/KCCObody/KCCOitem/phase/garConsumptionSet/dyeN) 0-99  (XPath KnitClothOrder/KCCObody/KCCOitem/apparelProd/dyeN) 0-1  (XPath KnitClothOrder/KCCObody/KCCOitem/apparelComponent/garmentPartComponent/dyeN) 0-1</p>
@email	<p>electronic mail address of the contact person within a Party</p> <p>- base type: string, max length: 250,  (XPath KnitClothOrder/KCCOheader/subContractor/person/@email) [Optional]  (XPath KnitClothOrder/KCCOheader/thirdParty/person/@email) [Optional]  (XPath KnitClothOrder/KCCOheader/buyer/person/@email) [Optional]  (XPath KnitClothOrder/KCCObody/KCCOitem/phase/thirdParty/person/@email) [Optional]  (XPath KnitClothOrder/KCCObody/KCCOitem/thirdParty/person/@email) [Optional]</p>
@encoding	<p>specifies the decoding algorithm of the binary object</p> <p>- base type: normalizedString,  (XPath KnitClothOrder/KCCObody/KCCOitem/appMnfrOperation/refDoc/attachment/binaryObject/@encoding) [Optional]  (XPath KnitClothOrder/KCCObody/KCCOitem/apparelComponent/acsComponent/refDoc/attachment/binaryObject/@encoding) [Optional]  (XPath KnitClothOrder/KCCObody/KCCOitem/apparelComponent/yarnComponent/refDoc/attachment/binaryObject/@encoding) [Optional]  (XPath KnitClothOrder/KCCObody/KCCOitem/apparelComponent/fabricComponent/refDoc/attachment/binaryObject/@encoding) [Optional]  (XPath KnitClothOrder/KCCObody/KCCOitem/garTecSheet/refDoc/attachment/binaryObject/@encoding) [Optional]  (XPath KnitClothOrder/KCCObody/KCCOitem/apparelComponent/garmentPartComponent/refDoc/attachment/binaryObject/@encoding) [Optional]  (XPath KnitClothOrder/KCCObody/KCCOitem/phase/refDoc/attachment/binaryObject/@encoding) [Optional]  (XPath KnitClothOrder/KCCOheader/refDoc/attachment/binaryObject/@encoding) [Optional]</p>
encodingCode	<p>the encoding/decoding algorithm used with the external object</p> <p>- base type: normalizedString,  (XPath KnitClothOrder/KCCObody/KCCOitem/apparelComponent/fabricComponent/refDoc/attachment/externalReference/encodingCode) 0-1  (XPath KnitClothOrder/KCCObody/KCCOitem/apparelComponent/garmentPartComponent/refDoc/attachment/externalReference/encodingCode) 0-1  (XPath KnitClothOrder/KCCObody/KCCOitem/appMnfrOperation/refDoc/attachment/externalReference/encodingCode) 0-1  (XPath KnitClothOrder/KCCObody/KCCOitem/garTecSheet/refDoc/attachment/externalReference/encodingCode) 0-1  (XPath KnitClothOrder/KCCOheader/refDoc/attachment/externalReference/encodingCode) 0-1  (XPath KnitClothOrder/KCCObody/KCCOitem/phase/refDoc/attachment/externalReference/encodingCode) 0-1</p>

	<p>(XPath KnitClothOrder/KCCObody/KCCOitem/apparelComponent/acsComponent/refDoc/attachment/externalReference/encodingCode) 0-1</p> <p>(XPath KnitClothOrder/KCCObody/KCCOitem/apparelComponent/yarnComponent/refDoc/attachment/externalReference/encodingCode) 0-1</p>
@endUse	<p>specifies the final use of the fabric</p> <p>- base type: string, cod. table: NT4</p> <p><a href="http://www.ebiz.enea.it/moda-ml/repository/codelist/draft/gc_NT4.xml">http://www.ebiz.enea.it/moda-ml/repository/codelist/draft/gc_NT4.xml</a></p> <p>(XPath KnitClothOrder/garComInfo/@endUse) [Optional]</p> <p>- nota: <i>When used for garments, use only PR: Production or SA: Sample codes.</i></p> <p>(XPath KnitClothOrder/KCCObody/KCCOitem/garComInfo/@endUse) [Optional]</p> <p>- nota: <i>When used for garments, use only PR: Production or SA: Sample codes.</i></p>
endUseGroupld	<p>group identifier.</p> <p>- base type: string,</p> <p>(XPath KnitClothOrder/KCCObody/KCCOitem/endUseGroup/endUseGroupld) 1-1</p>
EPC	<p>serial identifier used for tracing a physical item with RFID technology</p> <p>- base type: string,</p> <p>(XPath KnitClothOrder/KCCObody/KCCOitem/phase/packages/EPCList/EPC) 1-unbounded</p> <p>(XPath KnitClothOrder/KCCObody/KCCOitem/packages/EPCList/EPC) 1-unbounded</p>
fabric	<p>fabric number of the garment</p> <p>- base type: string, max length: 15,</p> <p>(XPath KnitClothOrder/KCCObody/KCCOitem/garTecSheet/garmentCode/garmentCodeB/fabric) 0-1</p> <p>(XPath KnitClothOrder/KCCObody/KCCOitem/garTecSheet/garConsumptionSet/garmentCode/garmentCodeB/fabric) 0-1</p> <p>(XPath KnitClothOrder/KCCObody/KCCOitem/phase/garConsumptionSet/garmentCode/garmentCodeB/fabric) 0-1</p> <p>(XPath KnitClothOrder/KCCObody/KCCOitem/apparelComponent/garmentPartComponent/garmentPartCode/fabric) 0-1</p> <p>- note: <i>when a garment component, it should be the code assigned to the garment article</i></p> <p>(XPath KnitClothOrder/KCCObody/KCCOitem/apparelProd/garmentPartCode/fabric) 0-1</p> <p>- note: <i>when a garment component, it should be the code assigned to the garment article</i></p> <p>(XPath KnitClothOrder/KCCObody/KCCOitem/garTecSheet/garConsumptionSet/garmentPartCode/fabric) 0-1</p> <p>- note: <i>when a garment component, it should be the code assigned to the garment article</i></p> <p>(XPath KnitClothOrder/KCCObody/KCCOitem/phase/garConsumptionSet/garmentPartCode/fabric) 0-1</p> <p>- note: <i>when a garment component, it should be the code assigned to the garment article</i></p> <p>(XPath KnitClothOrder/KCCObody/KCCOitem/apparelProd/garmentCode/garmentCodeB/fabric) 0-1</p>
@fax	<p>fax number of the contact person within a Party</p> <p>- base type: string, max length: 35,</p> <p>(XPath KnitClothOrder/KCCOheader/thirdParty/person/@fax) [Optional]</p> <p>(XPath KnitClothOrder/KCCOheader/buyer/person/@fax) [Optional]</p> <p>(XPath KnitClothOrder/KCCObody/KCCOitem/phase/thirdParty/person/@fax) [Optional]</p> <p>(XPath KnitClothOrder/KCCOheader/subContractor/person/@fax) [Optional]</p> <p>(XPath KnitClothOrder/KCCObody/KCCOitem/thirdParty/person/@fax) [Optional]</p>
@fibre	<p>type of fibre used in a textile product</p> <p>- base type: string, cod. table: T19</p> <p><a href="http://www.ebiz.enea.it/moda-ml/repository/codelist/draft/gc_T19.xml">http://www.ebiz.enea.it/moda-ml/repository/codelist/draft/gc_T19.xml</a></p>

	(XPath KnitClothOrder/KCCObody/KCCOitem/garTecSheet/fabricCompos/percCompos/@fibre) [Required]
fileName	<p>unique identifier (name) of the file</p> <p>- base type: string, max length: 255,</p> <p>(XPath KnitClothOrder/KCCObody/KCCOitem/apparelComponent/yarnComponent/refDoc/attachment/fileName) 0-1</p> <p>(XPath KnitClothOrder/KCCObody/KCCOitem/appMnfrOperation/refDoc/attachment/fileName) 0-1</p> <p>(XPath KnitClothOrder/KCCOheader/refDoc/attachment/fileName) 0-1</p> <p>(XPath KnitClothOrder/KCCObody/KCCOitem/apparelComponent/fabricComponent/refDoc/attachment/fileName) 0-1</p> <p>(XPath KnitClothOrder/KCCObody/KCCOitem/garTecSheet/refDoc/attachment/fileName) 0-1</p> <p>(XPath KnitClothOrder/KCCObody/KCCOitem/phase/refDoc/attachment/fileName) 0-1</p> <p>(XPath KnitClothOrder/KCCObody/KCCOitem/apparelComponent/acsComponent/refDoc/attachment/fileName) 0-1</p> <p>(XPath KnitClothOrder/KCCObody/KCCOitem/apparelComponent/garmentPartComponent/refDoc/attachment/fileName) 0-1</p>
fillingCriterion	<p>the assortment criterion to fill the specified kind of package: it states the homogeneity criterion (eg: "model", "color", "size").</p> <p>- base type: string, cod. table: NT51</p> <p><a href="http://www.ebiz.enea.it/moda-ml/repository/codelist/draft/gc_NT51.xml">http://www.ebiz.enea.it/moda-ml/repository/codelist/draft/gc_NT51.xml</a></p> <p>(XPath KnitClothOrder/KCCObody/KCCOitem/packages/fillingCriterion) 0-9</p> <p>(XPath KnitClothOrder/KCCObody/KCCOitem/phase/packages/fillingCriterion) 0-9</p>
finalIndicator	<p>final phase indicator.</p> <p>- base type: boolean,</p> <p>(XPath KnitClothOrder/KCCObody/KCCOitem/phase/finalIndicator) 0-1</p>
@finDiscount	<p>financial discount rate applied for payment by the date specified</p> <p>- base type: decimal, min inclusive: 0, max inclusive: 100, fraction digits: 2,</p> <p>(XPath KnitClothOrder/terms/payment/@finDiscount) [Optional]</p>
@finSurcharge	<p>financial surcharge rate applied for payment after the date specified</p> <p>- base type: decimal, min inclusive: 0, max inclusive: 100, fraction digits: 2,</p> <p>(XPath KnitClothOrder/terms/payment/@finSurcharge) [Optional]</p>
@format	<p>the format of the binary content</p> <p>- base type: string,</p> <p>(XPath KnitClothOrder/KCCObody/KCCOitem/apparelComponent/garmentPartComponent/refDoc/attachment/binaryObject/@format) [Optional]</p> <p>(XPath KnitClothOrder/KCCObody/KCCOitem/phase/refDoc/attachment/binaryObject/@format) [Optional]</p> <p>(XPath KnitClothOrder/KCCObody/KCCOitem/apparelComponent/fabricComponent/refDoc/attachment/binaryObject/@format) [Optional]</p> <p>(XPath KnitClothOrder/KCCOheader/refDoc/attachment/binaryObject/@format) [Optional]</p> <p>(XPath KnitClothOrder/KCCObody/KCCOitem/appMnfrOperation/refDoc/attachment/binaryObject/@format) [Optional]</p> <p>(XPath KnitClothOrder/KCCObody/KCCOitem/garTecSheet/refDoc/attachment/binaryObject/@format) [Optional]</p> <p>(XPath KnitClothOrder/KCCObody/KCCOitem/apparelComponent/acsComponent/refDoc/attachment/binaryObject/@format) [Optional]</p> <p>(XPath KnitClothOrder/KCCObody/KCCOitem/apparelComponent/yarnComponent/refDoc/attachment/binaryObject/@format) [Optional]</p>
formatCode	<p>the format of the external object</p> <p>- base type: normalizedString,</p> <p>(XPath KnitClothOrder/KCCObody/KCCOitem/appMnfrOperation/refDoc/attachment/externalReference/formatCode) 0-1</p> <p>(XPath KnitClothOrder/KCCObody/KCCOitem/apparelComponent/fabricComponent/refDoc/attachment/externalReference/formatCode) 0-1</p> <p>(XPath KnitClothOrder/KCCObody/KCCOitem/phase/refDoc/attachment/externalReference/formatCode) 0-1</p>

	<p>(XPath KnitClothOrder/KCCObody/KCCOitem/apparelComponent/garmentPartComponent/refDoc/attachment/externalReference/formatCode) 0-1</p> <p>(XPath KnitClothOrder/KCCObody/KCCOitem/apparelComponent/acsComponent/refDoc/attachment/externalReference/formatCode) 0-1</p> <p>(XPath KnitClothOrder/KCCOheader/refDoc/attachment/externalReference/formatCode) 0-1</p> <p>(XPath KnitClothOrder/KCCObody/KCCOitem/apparelComponent/yarnComponent/refDoc/attachment/externalReference/formatCode) 0-1</p> <p>(XPath KnitClothOrder/KCCObody/KCCOitem/garTecSheet/refDoc/attachment/externalReference/formatCode) 0-1</p>
garAttrib	<p>garment's attribute to which the measures are referred</p> <p>- base type: string, cod. table: NT41</p> <p><a href="http://www.ebiz.enea.it/moda-ml/repository/codelist/draft/gc_NT41.xml">http://www.ebiz.enea.it/moda-ml/repository/codelist/draft/gc_NT41.xml</a></p> <p>(XPath KnitClothOrder/KCCObody/KCCOitem/garTecSheet/garMeaSet/garAttrib) 1-1</p>
garPackCode	<p>a code specifying the type of packaging used for the item.</p> <p>- base type: string,</p> <p>(XPath KnitClothOrder/KCCObody/KCCOitem/packages/handlingChar/garPack/garPackCode) 1-1</p> <p>(XPath KnitClothOrder/KCCObody/KCCOitem/phase/packages/handlingChar/garPack/garPackCode) 1-1</p>
garPackText	<p>a free text specifying the type of packaging used for the item.</p> <p>- base type: string,</p> <p>(XPath KnitClothOrder/KCCObody/KCCOitem/packages/handlingChar/garPack/garPackText) 1-1</p> <p>(XPath KnitClothOrder/KCCObody/KCCOitem/phase/packages/handlingChar/garPack/garPackText) 1-1</p>
garSizeCode	<p>code of a range of sizes</p> <p>- base type: string, max length: 15,</p> <p>(XPath KnitClothOrder/KCCObody/KCCOitem/garTecSheet/garSizeSet/garSizeTier/garSizeCode) 1-1</p> <p>(XPath KnitClothOrder/KCCObody/KCCOitem/phase/garConsumptionSet/garConsumption/garSizeCode) 0-1</p> <p>(XPath KnitClothOrder/KCCObody/KCCOitem/garTecSheet/garConsumptionSet/garConsumption/garSizeCode) 0-1</p>
gPart	<p>code specifying the type of component or part of a fashion product (sleeve, neck, ...)</p> <p>- base type: string, cod. table: T48</p> <p><a href="http://www.ebiz.enea.it/moda-ml/repository/codelist/draft/gc_T48.xml">http://www.ebiz.enea.it/moda-ml/repository/codelist/draft/gc_T48.xml</a></p> <p>(XPath KnitClothOrder/KCCObody/KCCOitem/garTecSheet/garConsumptionSet/garmentPartCode/gPart) 1-1</p> <p>(XPath KnitClothOrder/KCCObody/KCCOitem/apparelProd/garmentPartCode/gPart) 1-1</p> <p>(XPath KnitClothOrder/KCCObody/KCCOitem/phase/garConsumptionSet/garmentPartCode/gPart) 1-1</p> <p>(XPath KnitClothOrder/KCCObody/KCCOitem/apparelComponent/garmentPartComponent/garmentPartCode/gPart) 1-1</p> <p>(XPath KnitClothOrder/KCCObody/KCCOitem/apparelComponent/gPart) 0-1</p>
grossWeight	<p>the gross weight, declared for transport or customs purpose</p> <p>- base type: decimal, min inclusive: 0, fraction digits: 2,</p> <p>(XPath KnitClothOrder/KCCObody/KCCOitem/garTecSheet/grossWeight) 0-1</p> <p>(XPath KnitClothOrder/KCCObody/KCCOitem/phase/packages/handlingChar/grossWeight) 0-1</p> <p>(XPath KnitClothOrder/terms/transInfo/grossWeight) 0-1</p> <p>(XPath KnitClothOrder/KCCObody/KCCOitem/packages/handlingChar/grossWeight) 0-1</p>
handlingType	<p>information to handle the item (eg "breakable").</p> <p>- base type: string,</p>



	<p>(XPath KnitClothOrder/KCCObody/KCCOitem/packages/handlingChar/handlingType) 0-1  (XPath KnitClothOrder/KCCObody/KCCOitem/phase/packages/handlingChar/handlingType) 0-1</p>
height	<p>effective height of a specified object  - base type: decimal, min inclusive: 0, fraction digits: 2,  (XPath KnitClothOrder/KCCObody/KCCOitem/packages/packageDim/height) 0-1  (XPath KnitClothOrder/KCCObody/KCCOitem/phase/packages/packageDim/height) 0-1</p>
id	<p>primary identification code of a Party; it is recommended the format: nation code (ISO 3166) + VAT identification number (11 crt), with the qualifier "numberingOrg"= MF  - base type: string, max length: 15,  (XPath KnitClothOrder/KCCOheader/buyer/id) 1-1  (XPath KnitClothOrder/KCCObody/KCCOitem/phase/thirdParty/id) 1-1  (XPath KnitClothOrder/KCCObody/KCCOitem/thirdParty/id) 1-1  (XPath KnitClothOrder/KCCOheader/thirdParty/id) 1-1  (XPath KnitClothOrder/KCCOheader/subContractor/id) 1-1</p>
@idQualifier	<p>Qualification of the identifier.  - base type: string,  (XPath KnitClothOrder/KCCObody/KCCOitem/phase/lotDetails/csRange/sizeMatrix/sizeRow/itemsList/itemIdentification/serialN/@idQualifier) [Optional]  - nota: <i>this attribute should be used when the numberingOrg attribute is not enough to declare the type of serial identifier</i>  (XPath KnitClothOrder/KCCObody/KCCOitem/progress/itemsList/itemIdentification/serialN/@idQualifier) [Optional]  - nota: <i>this attribute should be used when the numberingOrg attribute is not enough to declare the type of serial identifier</i>  (XPath KnitClothOrder/KCCObody/KCCOitem/apparelComponent/fabricComponent/itemsList/itemIdentification/serialN/@idQualifier) [Optional]  - nota: <i>this attribute should be used when the numberingOrg attribute is not enough to declare the type of serial identifier</i>  (XPath KnitClothOrder/KCCObody/KCCOitem/apparelComponent/fabricComponent/serialN/@idQualifier) [Optional]  - nota: <i>this attribute should be used when the numberingOrg attribute is not enough to declare the type of serial identifier</i>  (XPath KnitClothOrder/KCCOheader/buyer/additionalIdentifier/@idQualifier) [Optional]  - nota: <i>this attribute should be used when the numberingOrg attribute is not enough to declare the type of identifier</i>  (XPath KnitClothOrder/KCCObody/KCCOitem/endUseGroup/csRange/sizeMatrix/sizeRow/itemsList/itemIdentification/serialN/@idQualifier) [Optional]  - nota: <i>this attribute should be used when the numberingOrg attribute is not enough to declare the type of serial identifier</i>  (XPath KnitClothOrder/KCCObody/KCCOitem/apparelProd/csRange/sizeMatrix/sizeRow/itemsList/itemIdentification/serialN/@idQualifier) [Optional]  - nota: <i>this attribute should be used when the numberingOrg attribute is not enough to declare the type of serial identifier</i></p>
image	<p>URL address of an annexed image  - base type: string, max length: 255,  (XPath KnitClothOrder/KCCObody/KCCOitem/garTecSheet/image) 0-99</p>
incoTerm	<p>specification of the terms of trade (INCOTERMS)  - base type: string, cod. table: T3  <a href="http://www.ebiz.enea.it/moda-ml/repository/codelist/draft/gc_T3.xml">http://www.ebiz.enea.it/moda-ml/repository/codelist/draft/gc_T3.xml</a>  (XPath KnitClothOrder/terms/trade/incoTerm) 1-1</p>

incoTermText	free text specifying the terms of trade (incoterm, location) - base type: string, max length: 250, (XPath KnitClothOrder/terms/trade/incoTermText) 1-1
@isURL	it indicates if the referred element is an URL (true) or not (false) - base type: boolean, (XPath KnitClothOrder/KCCObody/KCCOitem/apparelComponent/yarnComponent/refDoc/attachment/externalReference/uri/@isURL) [Optional] [Default= true] - nota: <i>usage of URLs is recommended</i> (XPath KnitClothOrder/KCCObody/KCCOitem/appMnfrOperation/refDoc/attachment/externalReference/uri/@isURL) [Optional] [Default= true] - nota: <i>usage of URLs is recommended</i> (XPath KnitClothOrder/KCCObody/KCCOitem/apparelComponent/fabricComponent/refDoc/attachment/externalReference/uri/@isURL) [Optional] [Default= true] - nota: <i>usage of URLs is recommended</i> (XPath KnitClothOrder/KCCObody/KCCOitem/garTecSheet/refDoc/attachment/externalReference/uri/@isURL) [Optional] [Default= true] - nota: <i>usage of URLs is recommended</i> (XPath KnitClothOrder/KCCObody/KCCOitem/apparelComponent/acsComponent/refDoc/attachment/externalReference/uri/@isURL) [Optional] [Default= true] - nota: <i>usage of URLs is recommended</i> (XPath KnitClothOrder/KCCObody/KCCOitem/phase/refDoc/attachment/externalReference/uri/@isURL) [Optional] [Default= true] - nota: <i>usage of URLs is recommended</i> (XPath KnitClothOrder/KCCObody/KCCOitem/apparelComponent/garmentPartComponent/refDoc/attachment/externalReference/uri/@isURL) [Optional] [Default= true] - nota: <i>usage of URLs is recommended</i> (XPath KnitClothOrder/KCCOheader/refDoc/attachment/externalReference/uri/@isURL) [Optional] [Default= true] - nota: <i>usage of URLs is recommended</i>
itemID	number of the line/item of the referenced document - base type: string, max length: 6, (XPath KnitClothOrder/KCCObody/KCCOitem/apparelComponent/garmentPartComponent/refDoc/itemID) 0-1 (XPath KnitClothOrder/KCCObody/KCCOitem/apparelComponent/fabricComponent/refDoc/itemID) 0-1 (XPath KnitClothOrder/KCCObody/KCCOitem/appMnfrOperation/refDoc/itemID) 0-1 (XPath KnitClothOrder/KCCOheader/refDoc/itemID) 0-1 (XPath KnitClothOrder/KCCObody/KCCOitem/apparelComponent/acsComponent/refDoc/itemID) 0-1 (XPath KnitClothOrder/KCCObody/KCCOitem/phase/refDoc/itemID) 0-1 (XPath KnitClothOrder/KCCObody/KCCOitem/garTecSheet/refDoc/itemID) 0-1 (XPath KnitClothOrder/KCCObody/KCCOitem/apparelComponent/yarnComponent/refDoc/itemID) 0-1
itemsPerPackage	the quantity of items that can be contained in a package. - base type: decimal, (XPath KnitClothOrder/KCCObody/KCCOitem/packages/itemsPerPackage) 0-1 (XPath KnitClothOrder/KCCObody/KCCOitem/phase/packages/itemsPerPackage) 0-1
jobName	description of the elementary job - base type: string, max length: 40, (XPath KnitClothOrder/KCCObody/KCCOitem/appMnfrOperation/jobName) 1-1
@KCCOtype	type of Order. - base type: string, cod. table: NT1 <a href="http://www.ebiz.enea.it/moda-ml/repository/codelist/draft/gc_NT1.xml">http://www.ebiz.enea.it/moda-ml/repository/codelist/draft/gc_NT1.xml</a> (XPath KnitClothOrder/@KCCOtype) [Optional]

label	<p>indicates if the physical object specified has to be labelled</p> <p>- base type: boolean,</p> <p>(XPath KnitClothOrder/KCCObody/KCCOitem/phase/packages/handlingChar/yarnPack/yarnInWrap/label) 0-1</p> <p>(XPath KnitClothOrder/KCCObody/KCCOitem/packages/handlingChar/yarnPack/yarnReel/label) 0-1</p> <p>(XPath KnitClothOrder/KCCObody/KCCOitem/phase/packages/handlingChar/yarnPack/yarnReel/label) 0-1</p> <p>(XPath KnitClothOrder/KCCObody/KCCOitem/packages/handlingChar/yarnPack/yarnInWrap/label) 0-1</p>
labelWrit	<p>text that must be written on the lable of a specified physical object when its customization is required</p> <p>- base type: string, max length: 350,</p> <p>(XPath KnitClothOrder/KCCObody/KCCOitem/phase/packages/handlingChar/yarnPack/yarnInWrap/labelWrit) 0-1</p> <p>(XPath KnitClothOrder/KCCObody/KCCOitem/packages/handlingChar/yarnPack/yarnInWrap/labelWrit) 0-1</p> <p>(XPath KnitClothOrder/KCCObody/KCCOitem/packages/handlingChar/yarnPack/yarnReel/labelWrit) 0-1</p> <p>(XPath KnitClothOrder/KCCObody/KCCOitem/phase/packages/handlingChar/yarnPack/yarnReel/labelWrit) 0-1</p>
legalName	<p>legal name of a Party</p> <p>- base type: string, max length: 250,</p> <p>(XPath KnitClothOrder/KCCOheader/buyer/legalName) 0-1</p> <p>(XPath KnitClothOrder/KCCOheader/subContractor/legalName) 0-1</p> <p>(XPath KnitClothOrder/KCCObody/KCCOitem/thirdParty/legalName) 0-1</p> <p>(XPath KnitClothOrder/KCCOheader/thirdParty/legalName) 0-1</p> <p>(XPath KnitClothOrder/KCCObody/KCCOitem/phase/thirdParty/legalName) 0-1</p>
legalRef	<p>legal reference of the duty or tax or fee category</p> <p>- base type: string,</p> <p>(XPath KnitClothOrder/terms/allowanceCharge/dtScheme/legalRef) 0-1</p> <p>(XPath KnitClothOrder/KCCObody/KCCOitem/dtScheme/legalRef) 0-1</p>
length	<p>effective length of a specified object</p> <p>- base type: decimal, min inclusive: 0, fraction digits: 2,</p> <p>(XPath KnitClothOrder/KCCObody/KCCOitem/packages/packageDim/length) 1-1</p> <p>- note: <i>here the maximum dimension must also be specified</i></p> <p>(XPath KnitClothOrder/KCCObody/KCCOitem/phase/packages/packageDim/length) 1-1</p> <p>- note: <i>here the maximum dimension must also be specified</i></p>
lineID	<p>unique identifier of the line item of the business document; it is set by the role that produces the document.</p> <p>- base type: string, max length: 30,</p> <p>(XPath KnitClothOrder/KCCObody/KCCOitem/lineID) 0-1</p>
lineN	<p>number of the line item of the present message (xml document); it is set by the role that produces the document. Usually it is a progressive number, but not always.</p> <p>- base type: positiveInteger, min inclusive: 1, max inclusive: 9999,</p> <p>(XPath KnitClothOrder/KCCObody/KCCOitem/lineN) 1-1</p>
@listName	<p>the name of the list of codes used to make an instance of the element (it might be thought as descriptive element, i.e. 'fabric printing technologies', or not, i.e. "T264")</p> <p>- base type: string, max length: 40,</p> <p>(XPath KnitClothOrder/KCCObody/KCCOitem/apparelComponent/fabricComponent/texCode/color/@listName) [Optional]</p> <p>- nota: <i>this attribute should always be used coupled with "numberingOrg"</i></p> <p>(XPath KnitClothOrder/KCCObody/KCCOitem/phase/garConsumptionSet/acsCode/pattern/@listName) [Optional]</p>

- nota: *this attribute should always be used coupled with “numberingOrg”*  
(XPath KnitClothOrder/KCCObody/KCCOitem/apparelProd/  
garmentCode/garmentCodeB/artGroup/@listName) [Optional]

- nota: *this attribute should always be used coupled with “numberingOrg”*  
(XPath  
KnitClothOrder/KCCObody/KCCOitem/phase/garConsumptionSet/garmentC  
ode/garmentCodeB/garmentVariant/variantType/@listName) [Optional]

- nota: *this attribute should always be used coupled with “numberingOrg”*  
(XPath KnitClothOrder/KCCObody/KCCOitem/apparelProd/  
garmentCode/garmentCodeA/art/@listName) [Optional]

- nota: *this attribute should always be used coupled with “numberingOrg”*  
(XPath KnitClothOrder/KCCObody/KCCOitem/garTecSheet/  
garConsumptionSet/garmentCode/garmentCodeA/art/@listName) [Optional]

- nota: *this attribute should always be used coupled with “numberingOrg”*  
(XPath KnitClothOrder/KCCObody/KCCOitem/apparelComponent/  
fabricComponent/texCode/pattern/@listName) [Optional]

- nota: *this attribute should always be used coupled with “numberingOrg”*  
(XPath KnitClothOrder/KCCObody/KCCOitem/apparelComponent/  
fabricComponent/texCode/art/@listName) [Optional]

- nota: *this attribute should always be used coupled with “numberingOrg”*  
(XPath  
KnitClothOrder/KCCObody/KCCOitem/phase/garConsumptionSet/garmentP  
artCode/mod/@listName) [Optional]

- nota: *this attribute should always be used coupled with “numberingOrg”*  
(XPath KnitClothOrder/KCCObody/KCCOitem/endUseGroup/  
csRange/sizeMatrix/sizeRow/additionalComponentCode/@listName) [Option  
al]  
(XPath  
KnitClothOrder/KCCObody/KCCOitem/phase/garConsumptionSet/garmentC  
ode/garmentCodeB/garmentVariant/variantCode/@listName) [Optional]

- nota: *this attribute should always be used coupled with “numberingOrg”*  
(XPath KnitClothOrder/KCCObody/KCCOitem/phase/lotDetails/  
csRange/sizeMatrix/sizeRow/itemsList/qualityLevel/@listName) [Optional]  
(XPath  
KnitClothOrder/KCCObody/KCCOitem/phase/garConsumptionSet/texCode/c  
olor/@listName) [Optional]

- nota: *this attribute should always be used coupled with “numberingOrg”*  
(XPath KnitClothOrder/KCCObody/KCCOitem/endUseGroup/  
csRange/garmentVariant/variantType/@listName) [Optional]

- nota: *this attribute should always be used coupled with “numberingOrg”*  
(XPath KnitClothOrder/KCCObody/KCCOitem/garComInfo/  
operationalCode/@listName) [Optional]  
(XPath KnitClothOrder/KCCObody/KCCOitem/apparelProd/  
csRange/sizeMatrix/sizeRow/itemsList/qualityLevel/@listName) [Optional]  
(XPath KnitClothOrder/KCCObody/KCCOitem/apparelComponent/  
garmentPartComponent/garmentPartCode/color/@listName) [Optional]

- nota: *this attribute should always be used coupled with “numberingOrg”*  
(XPath KnitClothOrder/KCCObody/KCCOitem/garTecSheet/  
garmentCode/garmentCodeB/garmentVariant/variantType/@listName) [Optio  
nal]

- nota: *this attribute should always be used coupled with “numberingOrg”*  
(XPath KnitClothOrder/KCCObody/KCCOitem/garTecSheet/  
garmentCode/garmentCodeB/color/@listName) [Optional]

- nota: *this attribute should always be used coupled with “numberingOrg”*  
(XPath KnitClothOrder/KCCObody/KCCOitem/apparelComponent/  
fabricComponent/refDoc/season/@listName) [Optional]  
(XPath KnitClothOrder/KCCObody/KCCOitem/garTecSheet/  
garmentCode/garmentCodeB/garmentVariant/variantCode/@listName) [Opti  
onal]

- nota: *this attribute should always be used coupled with “numberingOrg”*  
(XPath KnitClothOrder/KCCObody/KCCOitem/apparelProd/  
csRange/garmentVariant/variantType/@listName) [Optional]

- nota: *this attribute should always be used coupled with “numberingOrg”*  
(XPath KnitClothOrder/KCCObody/KCCOitem/appMnfrOperation/  
refDoc/season/@listName) [Optional]

(XPath KnitClothOrder/KCCObody/KCCOitem/apparelComponent/garmentPartComponent/garmentPartCode/mod/@listName) [Optional]  
- nota: *this attribute should always be used coupled with “numberingOrg”*  
(XPath KnitClothOrder/KCCObody/KCCOitem/phase/phaseCode/@listName) [Optional]  
(XPath  
KnitClothOrder/KCCObody/KCCOitem/phase/garConsumptionSet/garmentCode/garmentCodeA/art/@listName) [Optional]  
- nota: *this attribute should always be used coupled with “numberingOrg”*  
(XPath KnitClothOrder/KCCObody/KCCOitem/apparelProd/csRange/sizeMatrix/sizeRow/additionalComponentCode/@listName) [Optional]  
(XPath KnitClothOrder/KCCObody/KCCOitem/apparelProd/csRange/garmentVariant/variantCode/@listName) [Optional]  
- nota: *this attribute should always be used coupled with “numberingOrg”*  
(XPath KnitClothOrder/KCCObody/KCCOitem/garTecSheet/garmentCode/garmentCodeB/fabric/@listName) [Optional]  
- nota: *this attribute should always be used coupled with “numberingOrg”*  
(XPath KnitClothOrder/KCCObody/KCCOitem/garTecSheet/garmentCode/garmentCodeB/mod/@listName) [Optional]  
- nota: *this attribute should always be used coupled with “numberingOrg”*  
(XPath KnitClothOrder/KCCObody/KCCOitem/garComInfo/productLine/@listName) [Optional]  
(XPath KnitClothOrder/KCCObody/KCCOitem/garComInfo/brand/@listName) [Optional]  
(XPath KnitClothOrder/KCCObody/KCCOitem/garTecSheet/garmentCode/garmentCodeA/art/@listName) [Optional]  
- nota: *this attribute should always be used coupled with “numberingOrg”*  
(XPath  
KnitClothOrder/KCCObody/KCCOitem/phase/garConsumptionSet/texCode/art/@listName) [Optional]  
- nota: *this attribute should always be used coupled with “numberingOrg”*  
(XPath  
KnitClothOrder/KCCObody/KCCOitem/phase/garConsumptionSet/texCode/pattern/@listName) [Optional]  
- nota: *this attribute should always be used coupled with “numberingOrg”*  
(XPath KnitClothOrder/KCCObody/KCCOitem/endUseGroup/csRange/color/@listName) [Optional]  
- nota: *this attribute should always be used coupled with “numberingOrg”*  
(XPath KnitClothOrder/KCCObody/KCCOitem/garTecSheet/refDoc/season/@listName) [Optional]  
(XPath KnitClothOrder/KCCObody/KCCOitem/phase/refDoc/season/@listName) [Optional]  
(XPath  
KnitClothOrder/KCCObody/KCCOitem/phase/garConsumptionSet/acsCode/color/@listName) [Optional]  
- nota: *this attribute should always be used coupled with “numberingOrg”*  
(XPath KnitClothOrder/KCCObody/KCCOitem/garTecSheet/garmentCode/garmentCodeB/artGroup/@listName) [Optional]  
- nota: *this attribute should always be used coupled with “numberingOrg”*  
(XPath KnitClothOrder/KCCObody/KCCOitem/apparelProd/csRange/color/@listName) [Optional]  
- nota: *this attribute should always be used coupled with “numberingOrg”*  
(XPath KnitClothOrder/KCCObody/KCCOitem/apparelComponent/fabricComponent/itemsList/qualityLevel/@listName) [Optional]  
(XPath KnitClothOrder/KCCObody/KCCOitem/apparelComponent/garmentPartComponent/garmentPartCode/fabric/@listName) [Optional]  
- nota: *this attribute should always be used coupled with “numberingOrg”*  
(XPath  
KnitClothOrder/KCCObody/KCCOitem/phase/garConsumptionSet/garmentCode/garmentCodeB/artGroup/@listName) [Optional]  
- nota: *this attribute should always be used coupled with “numberingOrg”*  
(XPath KnitClothOrder/KCCObody/KCCOitem/garTecSheet/garConsumptionSet/garmentPartCode/color/@listName) [Optional]  
- nota: *this attribute should always be used coupled with “numberingOrg”*

(XPath KnitClothOrder/KCCObody/KCCOitem/endUseGroup/csRange/garmentVariant/variantCode/@listName) [Optional]

- nota: *this attribute should always be used coupled with “numberingOrg”*

(XPath KnitClothOrder/KCCObody/KCCOitem/apparelComponent/yarnComponent/yarnCode/art/@listName) [Optional]

- nota: *this attribute should always be used coupled with “numberingOrg”*

(XPath KnitClothOrder/KCCObody/KCCOitem/phase/lotDetails/csRange/garmentVariant/variantType/@listName) [Optional]

- nota: *this attribute should always be used coupled with “numberingOrg”*

(XPath KnitClothOrder/garComInfo/operationalCode/@listName) [Optional]

(XPath KnitClothOrder/KCCObody/KCCOitem/garTecSheet/garConsumptionSet/garmentCode/garmentCodeB/mod/@listName) [Optional]

- nota: *this attribute should always be used coupled with “numberingOrg”*

(XPath KnitClothOrder/KCCObody/KCCOitem/apparelProd/garmentPartCode/color/@listName) [Optional]

- nota: *this attribute should always be used coupled with “numberingOrg”*

(XPath KnitClothOrder/KCCObody/KCCOitem/apparelComponent/acsComponent/acsCode/color/@listName) [Optional]

- nota: *this attribute should always be used coupled with “numberingOrg”*

(XPath KnitClothOrder/KCCObody/KCCOitem/phase/garConsumptionSet/yarnCode/art/@listName) [Optional]

- nota: *this attribute should always be used coupled with “numberingOrg”*

(XPath KnitClothOrder/garComInfo/productLine/@listName) [Optional]

(XPath KnitClothOrder/KCCObody/KCCOitem/garTecSheet/garConsumptionSet/yarnCode/color/@listName) [Optional]

- nota: *this attribute should always be used coupled with “numberingOrg”*

(XPath KnitClothOrder/KCCObody/KCCOitem/apparelProd/garmentCode/garmentCodeB/mod/@listName) [Optional]

- nota: *this attribute should always be used coupled with “numberingOrg”*

(XPath KnitClothOrder/KCCObody/KCCOitem/garTecSheet/garConsumptionSet/garmentPartCode/mod/@listName) [Optional]

- nota: *this attribute should always be used coupled with “numberingOrg”*

(XPath KnitClothOrder/KCCObody/KCCOitem/garTecSheet/garConsumptionSet/garmentPartCode/fabric/@listName) [Optional]

- nota: *this attribute should always be used coupled with “numberingOrg”*

(XPath KnitClothOrder/KCCObody/KCCOitem/apparelComponent/garmentPartComponent/refDoc/season/@listName) [Optional]

(XPath KnitClothOrder/KCCObody/KCCOitem/apparelComponent/yarnComponent/yarnCode/color/@listName) [Optional]

- nota: *this attribute should always be used coupled with “numberingOrg”*

(XPath KnitClothOrder/KCCObody/KCCOitem/garTecSheet/garConsumptionSet/garmentCode/garmentCodeB/garmentVariant/variantCode/@listName) [Optional]

- nota: *this attribute should always be used coupled with “numberingOrg”*

(XPath KnitClothOrder/KCCObody/KCCOitem/apparelProd/garmentPartCode/mod/@listName) [Optional]

- nota: *this attribute should always be used coupled with “numberingOrg”*

(XPath KnitClothOrder/KCCObody/KCCOitem/garTecSheet/garConsumptionSet/garmentCode/garmentCodeB/garmentVariant/variantType/@listName) [Optional]

- nota: *this attribute should always be used coupled with “numberingOrg”*

(XPath KnitClothOrder/KCCObody/KCCOitem/phase/garConsumptionSet/garmentPartCode/fabric/@listName) [Optional]

- nota: *this attribute should always be used coupled with “numberingOrg”*

(XPath KnitClothOrder/KCCObody/KCCOitem/apparelComponent/acsComponent/acsCode/art/@listName) [Optional]

- nota: *this attribute should always be used coupled with “numberingOrg”*

(XPath KnitClothOrder/KCCOheader/season/@listName) [Optional]

(XPath KnitClothOrder/KCCObody/KCCOitem/phase/lotDetails/csRange/garmentVariant/variantCode/@listName) [Optional]

- nota: *this attribute should always be used coupled with “numberingOrg”*

(XPath KnitClothOrder/KCCObody/KCCOitem/garTecSheet/  
garConsumptionSet/garmentCode/garmentCodeB/artGroup/@listName) [Optional]

- nota: *this attribute should always be used coupled with “numberingOrg”*

(XPath KnitClothOrder/KCCObody/KCCOitem/garTecSheet/  
garConsumptionSet/garmentCode/garmentCodeB/fabric/@listName) [Optional]

- nota: *this attribute should always be used coupled with “numberingOrg”*

(XPath KnitClothOrder/KCCObody/KCCOitem/apparelProd/  
garmentPartCode/fabric/@listName) [Optional]

- nota: *this attribute should always be used coupled with “numberingOrg”*

(XPath KnitClothOrder/KCCObody/KCCOitem/phase/garConsumptionSet/garmentPartCode/color/@listName) [Optional]

- nota: *this attribute should always be used coupled with “numberingOrg”*

(XPath KnitClothOrder/KCCObody/KCCOitem/phase/garConsumptionSet/yarnCode/color/@listName) [Optional]

- nota: *this attribute should always be used coupled with “numberingOrg”*

(XPath KnitClothOrder/KCCObody/KCCOitem/phase/lotDetails/  
csRange/sizeMatrix/sizeRow/additionalComponentCode/@listName) [Optional]

(XPath KnitClothOrder/KCCObody/KCCOitem/apparelComponent/  
acsComponent/acsCode/pattern/@listName) [Optional]

- nota: *this attribute should always be used coupled with “numberingOrg”*

(XPath KnitClothOrder/KCCObody/KCCOitem/garTecSheet/  
garConsumptionSet/garmentCode/garmentCodeB/color/@listName) [Optional]

- nota: *this attribute should always be used coupled with “numberingOrg”*

(XPath KnitClothOrder/KCCObody/KCCOitem/progress/  
itemsList/qualityLevel/@listName) [Optional]

(XPath KnitClothOrder/KCCObody/KCCOitem/phase/garConsumptionSet/acsCode/art/@listName) [Optional]

- nota: *this attribute should always be used coupled with “numberingOrg”*

(XPath KnitClothOrder/KCCObody/KCCOitem/apparelComponent/  
yarnComponent/refDoc/season/@listName) [Optional]

(XPath KnitClothOrder/KCCObody/KCCOitem/apparelProd/  
garmentCode/garmentCodeB/garmentVariant/variantType/@listName) [Optional]

- nota: *this attribute should always be used coupled with “numberingOrg”*

(XPath KnitClothOrder/KCCObody/KCCOitem/phase/garConsumptionSet/garmentCode/garmentCodeB/fabric/@listName) [Optional]

- nota: *this attribute should always be used coupled with “numberingOrg”*

(XPath KnitClothOrder/KCCObody/KCCOitem/garTecSheet/  
garConsumptionSet/texCode/art/@listName) [Optional]

- nota: *this attribute should always be used coupled with “numberingOrg”*

(XPath KnitClothOrder/KCCObody/KCCOitem/phase/garConsumptionSet/garmentCode/garmentCodeB/mod/@listName) [Optional]

- nota: *this attribute should always be used coupled with “numberingOrg”*

(XPath KnitClothOrder/KCCObody/KCCOitem/garTecSheet/  
garConsumptionSet/texCode/pattern/@listName) [Optional]

- nota: *this attribute should always be used coupled with “numberingOrg”*

(XPath KnitClothOrder/KCCObody/KCCOitem/apparelComponent/  
acsComponent/refDoc/season/@listName) [Optional]

(XPath KnitClothOrder/KCCObody/KCCOitem/garComInfo/season/@listName) [Optional]

(XPath KnitClothOrder/KCCObody/KCCOitem/garTecSheet/  
garConsumptionSet/acsCode/pattern/@listName) [Optional]

- nota: *this attribute should always be used coupled with “numberingOrg”*

(XPath KnitClothOrder/KCCObody/KCCOitem/garTecSheet/  
garConsumptionSet/acsCode/art/@listName) [Optional]

- nota: *this attribute should always be used coupled with “numberingOrg”*

	<p>(XPath KnitClothOrder/KCCObody/KCCOitem/phase/garConsumptionSet/garmentCode/garmentCodeB/color/@listName) [Optional]</p> <p>- nota: <i>this attribute should always be used coupled with “numberingOrg”</i></p> <p>(XPath KnitClothOrder/KCCObody/KCCOitem/endUseGroup/csRange/sizeMatrix/sizeRow/itemsList/qualityLevel/@listName) [Optional]</p> <p>(XPath KnitClothOrder/garComInfo/season/@listName) [Optional]</p> <p>(XPath KnitClothOrder/KCCObody/KCCOitem/garTecSheet/garConsumptionSet/acsCode/color/@listName) [Optional]</p> <p>- nota: <i>this attribute should always be used coupled with “numberingOrg”</i></p> <p>(XPath KnitClothOrder/KCCObody/KCCOitem/apparelProd/garmentCode/garmentCodeB/garmentVariant/variantCode/@listName) [Optional]</p> <p>- nota: <i>this attribute should always be used coupled with “numberingOrg”</i></p> <p>(XPath KnitClothOrder/garComInfo/brand/@listName) [Optional]</p> <p>(XPath KnitClothOrder/KCCObody/KCCOitem/apparelProd/garmentCode/garmentCodeB/color/@listName) [Optional]</p> <p>- nota: <i>this attribute should always be used coupled with “numberingOrg”</i></p> <p>(XPath KnitClothOrder/KCCObody/KCCOitem/garTecSheet/garConsumptionSet/texCode/color/@listName) [Optional]</p> <p>- nota: <i>this attribute should always be used coupled with “numberingOrg”</i></p> <p>(XPath KnitClothOrder/KCCObody/KCCOitem/apparelProd/garmentCode/garmentCodeB/fabric/@listName) [Optional]</p> <p>- nota: <i>this attribute should always be used coupled with “numberingOrg”</i></p> <p>(XPath KnitClothOrder/KCCObody/KCCOitem/garTecSheet/garConsumptionSet/yarnCode/art/@listName) [Optional]</p> <p>- nota: <i>this attribute should always be used coupled with “numberingOrg”</i></p> <p>(XPath KnitClothOrder/KCCOheader/refDoc/season/@listName) [Optional]</p> <p>(XPath KnitClothOrder/KCCObody/KCCOitem/phase/lotDetails/csRange/color/@listName) [Optional]</p> <p>- nota: <i>this attribute should always be used coupled with “numberingOrg”</i></p>
<p>@listVersion</p>	<p>it specifies the version of the list of codes used to make an instance of the element</p> <p>- base type: string, max length: 6,</p> <p>(XPath KnitClothOrder/KCCObody/KCCOitem/apparelComponent/acsComponent/acsCode/art/@listVersion) [Optional]</p> <p>- nota: <i>this attribute should always be used coupled with “numberingOrg” and “listName”</i></p> <p>(XPath KnitClothOrder/KCCObody/KCCOitem/phase/garConsumptionSet/acsCode/pattern/@listVersion) [Optional]</p> <p>- nota: <i>this attribute should always be used coupled with “numberingOrg” and “listName”</i></p> <p>(XPath KnitClothOrder/KCCObody/KCCOitem/endUseGroup/csRange/garmentVariant/variantCode/@listVersion) [Optional]</p> <p>- nota: <i>this attribute should always be used coupled with “numberingOrg” and “listName”</i></p> <p>(XPath KnitClothOrder/KCCObody/KCCOitem/phase/lotDetails/csRange/sizeMatrix/sizeRow/itemsList/qualityLevel/@listVersion) [Optional]</p> <p>(XPath KnitClothOrder/KCCObody/KCCOitem/endUseGroup/csRange/garmentVariant/variantType/@listVersion) [Optional]</p> <p>- nota: <i>this attribute should always be used coupled with “numberingOrg” and “listName”</i></p> <p>(XPath KnitClothOrder/KCCObody/KCCOitem/phase/garConsumptionSet/acsCode/color/@listVersion) [Optional]</p> <p>- nota: <i>this attribute should always be used coupled with “numberingOrg” and “listName”</i></p> <p>(XPath KnitClothOrder/KCCObody/KCCOitem/phase/lotDetails/csRange/garmentVariant/variantCode/@listVersion) [Optional]</p> <p>- nota: <i>this attribute should always be used coupled with “numberingOrg” and “listName”</i></p> <p>(XPath KnitClothOrder/KCCObody/KCCOitem/endUseGroup/csRange/color/@listVersion) [Optional]</p>



- nota: *this attribute should always be used coupled with “numberingOrg” and “listName”*  
(XPath KnitClothOrder/KCCObody/KCCOitem/phase/lotDetails/  
csRange/garmentVariant/variantType/@listVersion) [Optional]

- nota: *this attribute should always be used coupled with “numberingOrg” and “listName”*  
(XPath KnitClothOrder/KCCOheader/refDoc/season/@listVersion) [Optional]  
(XPath KnitClothOrder/KCCObody/KCCOitem/apparelComponent/  
garmentPartComponent/garmentPartCode/fabric/@listVersion) [Optional]

- nota: *this attribute should always be used coupled with “numberingOrg” and “listName”*  
(XPath KnitClothOrder/KCCObody/KCCOitem/apparelComponent/  
acsComponent/acsCode/color/@listVersion) [Optional]

- nota: *this attribute should always be used coupled with “numberingOrg” and “listName”*  
(XPath KnitClothOrder/KCCObody/KCCOitem/phase/refDoc/  
season/@listVersion) [Optional]  
(XPath KnitClothOrder/KCCObody/KCCOitem/apparelComponent/  
acsComponent/refDoc/season/@listVersion) [Optional]  
(XPath KnitClothOrder/KCCObody/KCCOitem/phase/lotDetails/  
csRange/sizeMatrix/sizeRow/additionalComponentCode/@listVersion) [Optional]

(XPath KnitClothOrder/KCCObody/KCCOitem/apparelComponent/  
garmentPartComponent/garmentPartCode/color/@listVersion) [Optional]

- nota: *this attribute should always be used coupled with “numberingOrg” and “listName”*  
(XPath KnitClothOrder/KCCObody/KCCOitem/apparelComponent/  
garmentPartComponent/garmentPartCode/mod/@listVersion) [Optional]

- nota: *this attribute should always be used coupled with “numberingOrg” and “listName”*  
(XPath KnitClothOrder/KCCObody/KCCOitem/apparelComponent/  
garmentPartComponent/refDoc/season/@listVersion) [Optional]  
(XPath KnitClothOrder/KCCObody/KCCOitem/apparelComponent/  
acsComponent/acsCode/pattern/@listVersion) [Optional]

- nota: *this attribute should always be used coupled with “numberingOrg” and “listName”*  
(XPath  
KnitClothOrder/KCCObody/KCCOitem/phase/garConsumptionSet/acsCode/  
art/@listVersion) [Optional]

- nota: *this attribute should always be used coupled with “numberingOrg” and “listName”*  
(XPath KnitClothOrder/KCCObody/KCCOitem/appMnfrOperation/  
refDoc/season/@listVersion) [Optional]  
(XPath KnitClothOrder/KCCObody/KCCOitem/phase/phaseCode/@listVersion) [Optional]  
(XPath KnitClothOrder/KCCObody/KCCOitem/phase/lotDetails/  
csRange/color/@listVersion) [Optional]

- nota: *this attribute should always be used coupled with “numberingOrg” and “listName”*  
(XPath KnitClothOrder/KCCObody/KCCOitem/garTecSheet/  
garConsumptionSet/texCode/color/@listVersion) [Optional]

- nota: *this attribute should always be used coupled with “numberingOrg” and “listName”*  
(XPath KnitClothOrder/KCCObody/KCCOitem/garTecSheet/  
garConsumptionSet/texCode/pattern/@listVersion) [Optional]

- nota: *this attribute should always be used coupled with “numberingOrg” and “listName”*  
(XPath  
KnitClothOrder/KCCObody/KCCOitem/phase/garConsumptionSet/garmentCode/garmentCodeB/mod/@listVersion) [Optional]

- nota: *this attribute should always be used coupled with “numberingOrg” and “listName”*  
(XPath KnitClothOrder/garComInfo/operationalCode/@listVersion) [Optional]  
(XPath KnitClothOrder/KCCObody/KCCOitem/garTecSheet/  
garConsumptionSet/garmentPartCode/mod/@listVersion) [Optional]

- nota: *this attribute should always be used coupled with “numberingOrg” and “listName”*  
(XPath KnitClothOrder/KCCObody/KCCOitem/garTecSheet/  
garConsumptionSet/yarnCode/color/@listVersion) [Optional]

- nota: *this attribute should always be used coupled with “numberingOrg” and “listName”*  
(XPath KnitClothOrder/KCCObody/KCCOitem/garTecSheet/  
garConsumptionSet/yarnCode/art/@listVersion) [Optional]

- nota: *this attribute should always be used coupled with “numberingOrg” and “listName”*  
(XPath KnitClothOrder/KCCObody/KCCOitem/garTecSheet/  
garConsumptionSet/acsCode/art/@listVersion) [Optional]

- nota: *this attribute should always be used coupled with “numberingOrg” and “listName”*  
(XPath  
KnitClothOrder/KCCObody/KCCOitem/phase/garConsumptionSet/garmentC  
ode/garmentCodeB/color/@listVersion) [Optional]

- nota: *this attribute should always be used coupled with “numberingOrg” and “listName”*  
(XPath KnitClothOrder/KCCObody/KCCOitem/garComInfo/  
operationalCode/@listVersion) [Optional]  
(XPath KnitClothOrder/KCCObody/KCCOitem/garTecSheet/  
garConsumptionSet/acsCode/pattern/@listVersion) [Optional]

- nota: *this attribute should always be used coupled with “numberingOrg” and “listName”*  
(XPath KnitClothOrder/KCCObody/KCCOitem/garTecSheet/  
garConsumptionSet/texCode/art/@listVersion) [Optional]

- nota: *this attribute should always be used coupled with “numberingOrg” and “listName”*  
(XPath KnitClothOrder/KCCObody/KCCOitem/garTecSheet/  
garConsumptionSet/acsCode/color/@listVersion) [Optional]

- nota: *this attribute should always be used coupled with “numberingOrg” and “listName”*  
(XPath  
KnitClothOrder/KCCObody/KCCOitem/phase/garConsumptionSet/garmentC  
ode/garmentCodeB/fabric/@listVersion) [Optional]

- nota: *this attribute should always be used coupled with “numberingOrg” and “listName”*  
(XPath KnitClothOrder/KCCObody/KCCOitem/garTecSheet/  
garConsumptionSet/garmentPartCode/fabric/@listVersion) [Optional]

- nota: *this attribute should always be used coupled with “numberingOrg” and “listName”*  
(XPath KnitClothOrder/KCCObody/KCCOitem/garTecSheet/  
garConsumptionSet/garmentCode/garmentCodeB/garmentVariant/variantCo  
de/@listVersion) [Optional]

- nota: *this attribute should always be used coupled with “numberingOrg” and “listName”*  
(XPath KnitClothOrder/garComInfo/brand/@listVersion) [Optional]  
(XPath  
KnitClothOrder/KCCObody/KCCOitem/phase/garConsumptionSet/garmentP  
artCode/fabric/@listVersion) [Optional]

- nota: *this attribute should always be used coupled with “numberingOrg” and “listName”*  
(XPath KnitClothOrder/KCCObody/KCCOitem/garTecSheet/  
garConsumptionSet/garmentCode/garmentCodeB/artGroup/@listVersion) [O  
ptional]

- nota: *this attribute should always be used coupled with “numberingOrg” and “listName”*  
(XPath  
KnitClothOrder/KCCObody/KCCOitem/phase/garConsumptionSet/garmentP  
artCode/mod/@listVersion) [Optional]

- nota: *this attribute should always be used coupled with “numberingOrg” and “listName”*  
(XPath KnitClothOrder/garComInfo/season/@listVersion) [Optional]

	<p>(XPath KnitClothOrder/KCCObody/KCCOitem/garTecSheet/garConsumptionSet/garmentCode/garmentCodeA/art/@listVersion) [Optional]</p> <p>] - nota: <i>this attribute should always be used coupled with “numberingOrg” and “listName”</i></p> <p>(XPath KnitClothOrder/KCCObody/KCCOitem/phase/garConsumptionSet/garmentPartCode/color/@listVersion) [Optional]</p> <p>- nota: <i>this attribute should always be used coupled with “numberingOrg” and “listName”</i></p> <p>(XPath KnitClothOrder/garComInfo/productLine/@listVersion) [Optional]</p> <p>(XPath KnitClothOrder/KCCObody/KCCOitem/garTecSheet/garConsumptionSet/garmentPartCode/color/@listVersion) [Optional]</p> <p>- nota: <i>this attribute should always be used coupled with “numberingOrg” and “listName”</i></p> <p>(XPath KnitClothOrder/KCCObody/KCCOitem/garTecSheet/garConsumptionSet/garmentCode/garmentCodeB/mod/@listVersion) [Optional]</p> <p>- nota: <i>this attribute should always be used coupled with “numberingOrg” and “listName”</i></p> <p>(XPath KnitClothOrder/KCCObody/KCCOitem/garTecSheet/garConsumptionSet/garmentCode/garmentCodeB/garmentVariant/variantType/@listVersion) [Optional]</p> <p>- nota: <i>this attribute should always be used coupled with “numberingOrg” and “listName”</i></p> <p>(XPath KnitClothOrder/KCCObody/KCCOitem/garTecSheet/garConsumptionSet/garmentCode/garmentCodeB/color/@listVersion) [Optional]</p> <p>- nota: <i>this attribute should always be used coupled with “numberingOrg” and “listName”</i></p> <p>(XPath KnitClothOrder/KCCObody/KCCOitem/garTecSheet/garConsumptionSet/garmentCode/garmentCodeB/fabric/@listVersion) [Optional]</p> <p>- nota: <i>this attribute should always be used coupled with “numberingOrg” and “listName”</i></p> <p>(XPath KnitClothOrder/KCCObody/KCCOitem/phase/garConsumptionSet/garmentCode/garmentCodeB/garmentVariant/variantType/@listVersion) [Optional]</p> <p>- nota: <i>this attribute should always be used coupled with “numberingOrg” and “listName”</i></p> <p>(XPath KnitClothOrder/KCCObody/KCCOitem/apparelProd/csRange/color/@listVersion) [Optional]</p> <p>- nota: <i>this attribute should always be used coupled with “numberingOrg” and “listName”</i></p> <p>(XPath KnitClothOrder/KCCObody/KCCOitem/garComInfo/brand/@listVersion) [Optional]</p> <p>(XPath KnitClothOrder/KCCObody/KCCOitem/apparelProd/garmentCode/garmentCodeB/mod/@listVersion) [Optional]</p> <p>- nota: <i>this attribute should always be used coupled with “numberingOrg” and “listName”</i></p> <p>(XPath KnitClothOrder/KCCObody/KCCOitem/apparelProd/csRange/garmentVariant/variantType/@listVersion) [Optional]</p> <p>- nota: <i>this attribute should always be used coupled with “numberingOrg” and “listName”</i></p> <p>(XPath KnitClothOrder/KCCObody/KCCOitem/apparelProd/csRange/sizeMatrix/sizeRow/additionalComponentCode/@listVersion) [Optional]</p> <p>(XPath KnitClothOrder/KCCObody/KCCOitem/apparelProd/csRange/garmentVariant/variantCode/@listVersion) [Optional]</p> <p>- nota: <i>this attribute should always be used coupled with “numberingOrg” and “listName”</i></p> <p>(XPath KnitClothOrder/KCCObody/KCCOitem/garComInfo/productLine/@listVersion) [Optional]</p>
--	---

(XPath KnitClothOrder/KCCObody/KCCOitem/apparelProd/garmentCode/garmentCodeB/garmentVariant/variantType/@listVersion) [Optional]  
- nota: *this attribute should always be used coupled with “numberingOrg” and “listName”*

(XPath KnitClothOrder/KCCObody/KCCOitem/apparelProd/garmentCode/garmentCodeB/color/@listVersion) [Optional]  
- nota: *this attribute should always be used coupled with “numberingOrg” and “listName”*

(XPath KnitClothOrder/KCCObody/KCCOitem/apparelProd/garmentCode/garmentCodeB/fabric/@listVersion) [Optional]  
- nota: *this attribute should always be used coupled with “numberingOrg” and “listName”*

(XPath KnitClothOrder/KCCObody/KCCOitem/apparelProd/garmentCode/garmentCodeB/garmentVariant/variantCode/@listVersion) [Optional]  
- nota: *this attribute should always be used coupled with “numberingOrg” and “listName”*

(XPath KnitClothOrder/KCCObody/KCCOitem/apparelProd/garmentCode/garmentCodeA/art/@listVersion) [Optional]  
- nota: *this attribute should always be used coupled with “numberingOrg” and “listName”*

(XPath KnitClothOrder/KCCObody/KCCOitem/garComInfo/season/@listVersion) [Optional]  
(XPath KnitClothOrder/KCCObody/KCCOitem/apparelProd/garmentCode/garmentCodeB/artGroup/@listVersion) [Optional]  
- nota: *this attribute should always be used coupled with “numberingOrg” and “listName”*

(XPath KnitClothOrder/KCCObody/KCCOitem/apparelProd/csRange/sizeMatrix/sizeRow/itemsList/qualityLevel/@listVersion) [Optional]  
(XPath KnitClothOrder/KCCObody/KCCOitem/garTecSheet/garmentCode/garmentCodeB/artGroup/@listVersion) [Optional]  
- nota: *this attribute should always be used coupled with “numberingOrg” and “listName”*

(XPath KnitClothOrder/KCCObody/KCCOitem/garTecSheet/garmentCode/garmentCodeB/garmentVariant/variantCode/@listVersion) [Optional]  
- nota: *this attribute should always be used coupled with “numberingOrg” and “listName”*

(XPath KnitClothOrder/KCCObody/KCCOitem/garTecSheet/garmentCode/garmentCodeB/garmentVariant/variantType/@listVersion) [Optional]  
- nota: *this attribute should always be used coupled with “numberingOrg” and “listName”*

(XPath KnitClothOrder/KCCObody/KCCOitem/phase/garConsumptionSet/garmentCode/garmentCodeB/artGroup/@listVersion) [Optional]  
- nota: *this attribute should always be used coupled with “numberingOrg” and “listName”*

(XPath KnitClothOrder/KCCObody/KCCOitem/phase/garConsumptionSet/garmentCode/garmentCodeB/garmentVariant/variantCode/@listVersion) [Optional]  
- nota: *this attribute should always be used coupled with “numberingOrg” and “listName”*

(XPath KnitClothOrder/KCCObody/KCCOitem/garTecSheet/refDoc/season/@listVersion) [Optional]  
(XPath KnitClothOrder/KCCObody/KCCOitem/garTecSheet/garmentCode/garmentCodeA/art/@listVersion) [Optional]  
- nota: *this attribute should always be used coupled with “numberingOrg” and “listName”*

(XPath KnitClothOrder/KCCObody/KCCOitem/apparelProd/garmentPartCode/mod/@listVersion) [Optional]  
- nota: *this attribute should always be used coupled with “numberingOrg” and “listName”*

(XPath KnitClothOrder/KCCObody/KCCOitem/apparelProd/garmentPartCode/fabric/@listVersion) [Optional]  
- nota: *this attribute should always be used coupled with “numberingOrg” and “listName”*

(XPath KnitClothOrder/KCCObody/KCCOitem/apparelProd/garmentPartCode/color/@listVersion) [Optional]  
- nota: *this attribute should always be used coupled with “numberingOrg” and “listName”*

(XPath KnitClothOrder/KCCObody/KCCOitem/phase/garConsumptionSet/garmentCode/garmentCodeA/art/@listVersion) [Optional]  
- nota: *this attribute should always be used coupled with “numberingOrg” and “listName”*

(XPath KnitClothOrder/KCCObody/KCCOitem/garTecSheet/garmentCode/garmentCodeB/color/@listVersion) [Optional]  
- nota: *this attribute should always be used coupled with “numberingOrg” and “listName”*

(XPath KnitClothOrder/KCCObody/KCCOitem/garTecSheet/garmentCode/garmentCodeB/fabric/@listVersion) [Optional]  
- nota: *this attribute should always be used coupled with “numberingOrg” and “listName”*

(XPath KnitClothOrder/KCCObody/KCCOitem/garTecSheet/garmentCode/garmentCodeB/mod/@listVersion) [Optional]  
- nota: *this attribute should always be used coupled with “numberingOrg” and “listName”*

(XPath KnitClothOrder/KCCOheader/season/@listVersion) [Optional]  
(XPath KnitClothOrder/KCCObody/KCCOitem/apparelComponent/yarnComponent/yarnCode/color/@listVersion) [Optional]  
- nota: *this attribute should always be used coupled with “numberingOrg” and “listName”*

(XPath KnitClothOrder/KCCObody/KCCOitem/endUseGroup/csRange/sizeMatrix/sizeRow/additionalComponentCode/@listVersion) [Optional]  
(XPath KnitClothOrder/KCCObody/KCCOitem/apparelComponent/yarnComponent/refDoc/season/@listVersion) [Optional]  
(XPath KnitClothOrder/KCCObody/KCCOitem/phase/garConsumptionSet/yarnCode/color/@listVersion) [Optional]  
- nota: *this attribute should always be used coupled with “numberingOrg” and “listName”*

(XPath KnitClothOrder/KCCObody/KCCOitem/progress/itemsList/qualityLevel/@listVersion) [Optional]  
(XPath KnitClothOrder/KCCObody/KCCOitem/phase/garConsumptionSet/yarnCode/art/@listVersion) [Optional]  
- nota: *this attribute should always be used coupled with “numberingOrg” and “listName”*

(XPath KnitClothOrder/KCCObody/KCCOitem/apparelComponent/yarnComponent/yarnCode/art/@listVersion) [Optional]  
- nota: *this attribute should always be used coupled with “numberingOrg” and “listName”*

(XPath KnitClothOrder/KCCObody/KCCOitem/apparelComponent/fabricComponent/texCode/color/@listVersion) [Optional]  
- nota: *this attribute should always be used coupled with “numberingOrg” and “listName”*

(XPath KnitClothOrder/KCCObody/KCCOitem/phase/garConsumptionSet/texCode/pattern/@listVersion) [Optional]  
- nota: *this attribute should always be used coupled with “numberingOrg” and “listName”*

(XPath KnitClothOrder/KCCObody/KCCOitem/phase/garConsumptionSet/texCode/art/@listVersion) [Optional]  
- nota: *this attribute should always be used coupled with “numberingOrg” and “listName”*

	<p>(XPath KnitClothOrder/KCCObody/KCCOitem/apparelComponent/fabricComponent/itemsList/qualityLevel/@listVersion) [Optional]</p> <p>(XPath KnitClothOrder/KCCObody/KCCOitem/phase/garConsumptionSet/texCode/color/@listVersion) [Optional]</p> <p>- nota: <i>this attribute should always be used coupled with “numberingOrg” and “listName”</i></p> <p>(XPath KnitClothOrder/KCCObody/KCCOitem/apparelComponent/fabricComponent/refDoc/season/@listVersion) [Optional]</p> <p>(XPath KnitClothOrder/KCCObody/KCCOitem/apparelComponent/fabricComponent/texCode/pattern/@listVersion) [Optional]</p> <p>- nota: <i>this attribute should always be used coupled with “numberingOrg” and “listName”</i></p> <p>(XPath KnitClothOrder/KCCObody/KCCOitem/apparelComponent/fabricComponent/texCode/art/@listVersion) [Optional]</p> <p>- nota: <i>this attribute should always be used coupled with “numberingOrg” and “listName”</i></p> <p>(XPath KnitClothOrder/KCCObody/KCCOitem/endUseGroup/csRange/sizeMatrix/sizeRow/itemsList/qualityLevel/@listVersion) [Optional]</p>
@In	<p>Language code.</p> <p>- base type: string,</p> <p>(XPath KnitClothOrder/KCCObody/KCCOitem/phase/garConsumptionSet/garmentPartCode/description/@In) [Optional]</p> <p>(XPath KnitClothOrder/KCCObody/KCCOitem/phase/packages/description/@In) [Optional]</p> <p>(XPath KnitClothOrder/KCCObody/KCCOitem/garTecSheet/garConsumptionSet/garmentCode/garmentCodeB/description/@In) [Optional]</p> <p>]</p> <p>(XPath KnitClothOrder/KCCObody/KCCOitem/garTecSheet/garConsumptionSet/garmentCode/garmentCodeA/description/@In) [Optional]</p> <p>]</p> <p>(XPath KnitClothOrder/KCCObody/KCCOitem/apparelComponent/acsComponent/acsCode/description/@In) [Optional]</p> <p>(XPath KnitClothOrder/KCCObody/KCCOitem/garTecSheet/garConsumptionSet/yarnCode/description/@In) [Optional]</p> <p>(XPath KnitClothOrder/KCCObody/KCCOitem/packages/description/@In) [Optional]</p> <p>(XPath KnitClothOrder/KCCObody/KCCOitem/garTecSheet/garmentCode/garmentCodeA/description/@In) [Optional]</p> <p>(XPath KnitClothOrder/KCCObody/KCCOitem/apparelComponent/garmentPartComponent/garmentPartCode/description/@In) [Optional]</p> <p>(XPath KnitClothOrder/KCCObody/KCCOitem/garTecSheet/garConsumptionSet/texCode/description/@In) [Optional]</p> <p>(XPath KnitClothOrder/KCCObody/KCCOitem/apparelComponent/yarnComponent/yarnCode/description/@In) [Optional]</p> <p>(XPath KnitClothOrder/KCCObody/KCCOitem/garTecSheet/garmentCode/garmentCodeB/description/@In) [Optional]</p> <p>(XPath KnitClothOrder/KCCObody/KCCOitem/apparelProd/garmentCode/garmentCodeB/description/@In) [Optional]</p> <p>(XPath KnitClothOrder/KCCObody/KCCOitem/packages/handlingChar/handlingType/@In) [Optional]</p> <p>(XPath KnitClothOrder/KCCObody/KCCOitem/apparelComponent/fabricComponent/texCode/description/@In) [Optional]</p> <p>(XPath KnitClothOrder/KCCObody/KCCOitem/phase/garConsumptionSet/garmentCode/garmentCodeA/description/@In) [Optional]</p> <p>(XPath KnitClothOrder/KCCObody/KCCOitem/phase/garConsumptionSet/yarnCode/description/@In) [Optional]</p> <p>(XPath KnitClothOrder/KCCObody/KCCOitem/phase/packages/handlingChar/handlingType/@In) [Optional]</p> <p>(XPath KnitClothOrder/KCCObody/KCCOitem/garTecSheet/garConsumptionSet/acsCode/description/@In) [Optional]</p>

	<p>(XPath KnitClothOrder/KCCObody/KCCOitem/phase/garConsumptionSet/acsCode/description/@In) [Optional]</p> <p>(XPath KnitClothOrder/KCCObody/KCCOitem/apparelProd/garmentCodeA/garmentCodeA/description/@In) [Optional]</p> <p>(XPath KnitClothOrder/KCCObody/KCCOitem/garTecSheet/garConsumptionSet/garmentPartCode/description/@In) [Optional]</p> <p>(XPath KnitClothOrder/KCCObody/KCCOitem/apparelProd/garmentPartCode/description/@In) [Optional]</p> <p>(XPath KnitClothOrder/KCCObody/KCCOitem/phase/garConsumptionSet/texCode/description/@In) [Optional]</p> <p>(XPath KnitClothOrder/KCCObody/KCCOitem/phase/garConsumptionSet/garmentCode/garmentCodeB/description/@In) [Optional]</p>
location	<p>specification of a location</p> <p>- base type: string, max length: 40,</p> <p>(XPath KnitClothOrder/KCCObody/KCCOitem/apparelComponent/acsComponent/location) 0-1</p> <p>(XPath KnitClothOrder/KCCObody/KCCOitem/apparelComponent/fabricComponent/location) 0-1</p> <p>- note: <i>it may be used to specify the location where lie the pieces that the Subcontractor must use for the commissioned work operation</i></p> <p>(XPath KnitClothOrder/KCCObody/KCCOitem/apparelComponent/garmentPartComponent/location) 0-1</p> <p>(XPath KnitClothOrder/KCCObody/KCCOitem/apparelComponent/yarnComponent/location) 0-1</p> <p>- note: <i>here the storage place of the component can be specified</i></p> <p>(XPath KnitClothOrder/terms/trade/location) 0-1</p> <p>- note: <i>place to which the INCOTERM applies</i></p>
@logo	<p>company logo (URL of the image jpeg or gif). It is recommended that the width of the image does not exceed 640 pixel.</p> <p>- base type: string, max length: 255,</p> <p>(XPath KnitClothOrder/KCCOheader/buyer/@logo) [Optional]</p>
lotN	<p>lot number of a product or batch number of the raw material</p> <p>- base type: string, max length: 15,</p> <p>(XPath KnitClothOrder/KCCObody/KCCOitem/phase/lotDetails/lotN) 1-1</p> <p>(XPath KnitClothOrder/KCCObody/KCCOitem/garTecSheet/garConsumptionSet/lotN) 0-99</p> <p>(XPath KnitClothOrder/KCCObody/KCCOitem/apparelProd/lotN) 0-1</p> <p>(XPath KnitClothOrder/KCCObody/KCCOitem/apparelComponent/acsComponent/lotN) 0-1</p> <p>(XPath KnitClothOrder/KCCObody/KCCOitem/phase/garConsumptionSet/lotN) 0-99</p> <p>(XPath KnitClothOrder/KCCObody/KCCOitem/apparelComponent/garmentPartComponent/lotN) 0-1</p> <p>(XPath KnitClothOrder/KCCObody/KCCOitem/apparelComponent/yarnComponent/lotN) 0-1</p>
@LRI	<p>attribute usable to format a string according to a customized User rule (local rule)</p> <p>- base type: string, cod. table: NT3</p> <p><a href="http://www.ebiz.enea.it/moda-ml/repository/codelist/draft/gc_NT3.xml">http://www.ebiz.enea.it/moda-ml/repository/codelist/draft/gc_NT3.xml</a></p> <p>(XPath KnitClothOrder/KCCObody/KCCOitem/apparelComponent/acsComponent/location/@LRI) [Optional]</p> <p>(XPath KnitClothOrder/KCCObody/KCCOitem/apparelComponent/yarnComponent/location/@LRI) [Optional]</p> <p>(XPath KnitClothOrder/KCCObody/KCCOitem/apparelComponent/garmentPartComponent/location/@LRI) [Optional]</p> <p>(XPath KnitClothOrder/terms/trade/location/@LRI) [Optional]</p> <p>(XPath KnitClothOrder/KCCObody/KCCOitem/apparelComponent/fabricComponent/location/@LRI) [Optional]</p>

@maxQty	<p>maximum product quantity</p> <ul style="list-style-type: none"> <li>- base type: decimal, min inclusive: 0, fraction digits: 2, (XPath KnitClothOrder/terms/allowanceCharge/@maxQty) [Optional]</li> <li>- nota: <i>maximum quantity of product for the application of this allowance or charge</i></li> </ul>
@method	<p>standard protocol or method employed in a test to evaluate a characteristic or a parameter</p> <ul style="list-style-type: none"> <li>- base type: string, max length: 80, (XPath KnitClothOrder/KCCObody/KCCOitem/garTecSheet/garMeaSet/garMea/specValue/@method) [Optional]</li> </ul>
mfrStatus	<p>code of the manufacturing stage used to describe the progress in the production cycle</p> <ul style="list-style-type: none"> <li>- base type: string, cod. table: T7 <a href="http://www.ebiz.enea.it/moda-ml/repository/codelist/draft/gc_T7.xml">http://www.ebiz.enea.it/moda-ml/repository/codelist/draft/gc_T7.xml</a> (XPath KnitClothOrder/KCCObody/KCCOitem/progress/mfrStatus) 0-1</li> </ul>
mfrStatusText	<p>free text description of the manufacturing stage used to specify the progress in the production cycle</p> <ul style="list-style-type: none"> <li>- base type: string, max length: 250, (XPath KnitClothOrder/KCCObody/KCCOitem/progress/mfrStatusText) 0-1</li> </ul>
@mime	<p>the mime type of the binary object</p> <ul style="list-style-type: none"> <li>- base type: normalizedString, (XPath KnitClothOrder/KCCObody/KCCOitem/garTecSheet/refDoc/attachment/binaryObject/@mime) [Optional]</li> <li>(XPath KnitClothOrder/KCCOheader/refDoc/attachment/binaryObject/@mime) [Optional]</li> <li>(XPath KnitClothOrder/KCCObody/KCCOitem/appMnfrOperation/refDoc/attachment/binaryObject/@mime) [Optional]</li> <li>(XPath KnitClothOrder/KCCObody/KCCOitem/phase/refDoc/attachment/binaryObject/@mime) [Optional]</li> <li>(XPath KnitClothOrder/KCCObody/KCCOitem/apparelComponent/fabricComponent/refDoc/attachment/binaryObject/@mime) [Optional]</li> <li>(XPath KnitClothOrder/KCCObody/KCCOitem/apparelComponent/garmentPartComponent/refDoc/attachment/binaryObject/@mime) [Optional]</li> <li>(XPath KnitClothOrder/KCCObody/KCCOitem/apparelComponent/acsComponent/refDoc/attachment/binaryObject/@mime) [Optional]</li> <li>(XPath KnitClothOrder/KCCObody/KCCOitem/apparelComponent/yarnComponent/refDoc/attachment/binaryObject/@mime) [Optional]</li> </ul>
mimeCode	<p>mime type of the external object</p> <ul style="list-style-type: none"> <li>- base type: normalizedString, (XPath KnitClothOrder/KCCObody/KCCOitem/apparelComponent/fabricComponent/refDoc/attachment/externalReference/mimeCode) 0-1</li> <li>(XPath KnitClothOrder/KCCObody/KCCOitem/apparelComponent/yarnComponent/refDoc/attachment/externalReference/mimeCode) 0-1</li> <li>(XPath KnitClothOrder/KCCObody/KCCOitem/apparelComponent/garmentPartComponent/refDoc/attachment/externalReference/mimeCode) 0-1</li> <li>(XPath KnitClothOrder/KCCObody/KCCOitem/phase/refDoc/attachment/externalReference/mimeCode) 0-1</li> <li>(XPath KnitClothOrder/KCCObody/KCCOitem/apparelComponent/acsComponent/refDoc/attachment/externalReference/mimeCode) 0-1</li> <li>(XPath KnitClothOrder/KCCOheader/refDoc/attachment/externalReference/mimeCode) 0-1</li> <li>(XPath KnitClothOrder/KCCObody/KCCOitem/appMnfrOperation/refDoc/attachment/externalReference/mimeCode) 0-1</li> <li>(XPath KnitClothOrder/KCCObody/KCCOitem/garTecSheet/refDoc/attachment/externalReference/mimeCode) 0-1</li> </ul>
minItemsPerPackage	<p>the minimum quantity of items for the specified kind of package.</p> <ul style="list-style-type: none"> <li>- base type: decimal, min inclusive: 0, (XPath KnitClothOrder/KCCObody/KCCOitem/phase/packages/minItemsPerPackage) 0-1</li> <li>(XPath KnitClothOrder/KCCObody/KCCOitem/packages/minItemsPerPackage) 0-1</li> </ul>



@minQty	<p>minimum product quantity</p> <ul style="list-style-type: none"> <li>- base type: decimal, min inclusive: 0, fraction digits: 2, (XPath KnitClothOrder/terms/allowanceCharge/@minQty) [Optional]</li> <li>- nota: <i>minimum quantity of product for the application of this allowance or charge</i></li> </ul>
mnfrNote	<p>free text manufacturing note</p> <ul style="list-style-type: none"> <li>- base type: string, max length: 350, (XPath KnitClothOrder/KCCObody/KCCOitem/garTecSheet/mnfrNote) 0-99</li> </ul>
mod	<p>model number of the garment</p> <ul style="list-style-type: none"> <li>- base type: string, max length: 15, (XPath KnitClothOrder/KCCObody/KCCOitem/apparelComponent/garmentPartComponent/garmentPartCode/mod) 1-1</li> <li>- note: <i>when a garment component, it should be the code assigned to the garment article</i> (XPath KnitClothOrder/KCCObody/KCCOitem/phase/garConsumptionSet/garmentPartCode/mod) 1-1</li> <li>- note: <i>when a garment component, it should be the code assigned to the garment article</i> (XPath KnitClothOrder/KCCObody/KCCOitem/apparelProd/garmentPartCode/mod) 1-1</li> <li>- note: <i>when a garment component, it should be the code assigned to the garment article</i> (XPath KnitClothOrder/KCCObody/KCCOitem/garTecSheet/garmentCode/garmentCodeB/mod) 1-1</li> <li>(XPath KnitClothOrder/KCCObody/KCCOitem/garTecSheet/garConsumptionSet/garmentPartCode/mod) 1-1</li> <li>- note: <i>when a garment component, it should be the code assigned to the garment article</i> (XPath KnitClothOrder/KCCObody/KCCOitem/apparelProd/garmentCode/garmentCodeB/mod) 1-1</li> <li>(XPath KnitClothOrder/KCCObody/KCCOitem/phase/garConsumptionSet/garmentCode/garmentCodeB/mod) 1-1</li> <li>(XPath KnitClothOrder/KCCObody/KCCOitem/garTecSheet/garConsumptionSet/garmentCode/garmentCodeB/mod) 1-1</li> </ul>
msgCurrency	<p>currency used to express the monetary amounts of the message</p> <ul style="list-style-type: none"> <li>- base type: string, cod. table: T9 <a href="http://www.ebiz.enea.it/moda-ml/repository/codelist/draft/gc_T9.xml">http://www.ebiz.enea.it/moda-ml/repository/codelist/draft/gc_T9.xml</a> (XPath KnitClothOrder/KCCOheader/msgCurrency) 0-1</li> </ul>
msgDate	<p>date of issue of the present message (xml document), according to one of the patterns YYYY-MM-DD, YYYY-MM-DD:HH-MM or YYYY-WW.</p> <ul style="list-style-type: none"> <li>- base type: string, (XPath KnitClothOrder/KCCOheader/msgDate) 1-1</li> </ul>
@msgfunction	<p>function performed by the present message with regards to the transmission</p> <ul style="list-style-type: none"> <li>- base type: string, cod. table: NT18 <a href="http://www.ebiz.enea.it/moda-ml/repository/codelist/draft/gc_NT18.xml">http://www.ebiz.enea.it/moda-ml/repository/codelist/draft/gc_NT18.xml</a> (XPath KnitClothOrder/@msgfunction) [Optional] [Default= OR]</li> </ul>
msgID	<p>key identifier of the business document in the information system of the issuing Party. In case of more despatches of the same business document, it is unchanged.</p> <ul style="list-style-type: none"> <li>- base type: string, max length: 35, (XPath KnitClothOrder/KCCOheader/msgID) 0-1</li> </ul>
msgN	<p>identification number given to the message (xml document) by its issuer. In case of more despatches of the same business document, it changes.</p> <ul style="list-style-type: none"> <li>- base type: string, max length: 35, (XPath KnitClothOrder/KCCOheader/msgN) 1-1</li> </ul>

netWeight	<p>the net weight declared for transport or customs purpose</p> <ul style="list-style-type: none"> <li>- base type: decimal, min inclusive: 0, fraction digits: 2,</li> <li>(XPath KnitClothOrder/KCCObody/KCCOitem/garTecSheet/netWeight) 0-1</li> <li>(XPath KnitClothOrder/KCCObody/KCCOitem/phase/packages/handlingChar/netWeight) 0-1</li> <li>(XPath KnitClothOrder/KCCObody/KCCOitem/packages/handlingChar/netWeight) 0-1</li> <li>(XPath KnitClothOrder/terms/transInfo/netWeight) 0-1</li> </ul>
notBeforeDate	<p>earliest date possible to begin an activity, according to one of the patterns YYYY-MM-DD, YYYY-MM-DD:HH-MM or YYYY-WW.</p> <ul style="list-style-type: none"> <li>- base type: string,</li> <li>(XPath KnitClothOrder/KCCObody/KCCOitem/phase/notBeforeDate) 0-1</li> </ul>
note	<p>free text or structured (computer processing) note. For note structuring use the attributes "noteLabel" and "codelist"</p> <ul style="list-style-type: none"> <li>- base type: string, max length: 350,</li> <li>(XPath KnitClothOrder/KCCObody/KCCOitem/appMnfrOperation/note) 0-99</li> <li>(XPath KnitClothOrder/KCCObody/KCCOitem/apparelComponent/fabricComponent/note) 0-99</li> <li>(XPath KnitClothOrder/KCCOheader/note) 0-99</li> <li>(XPath KnitClothOrder/KCCObody/KCCOitem/apparelComponent/acsComponent/note) 0-99</li> <li>(XPath KnitClothOrder/KCCObody/KCCOitem/apparelComponent/yarnComponent/note) 0-99</li> <li>(XPath KnitClothOrder/KCCObody/KCCOitem/note) 0-99</li> <li>(XPath KnitClothOrder/KCCObody/KCCOitem/phase/packages/handlingChar/note) 0-99</li> <li>(XPath KnitClothOrder/KCCObody/KCCOitem/garComInfo/note) 0-99</li> <li>(XPath KnitClothOrder/KCCObody/KCCOitem/dtScheme/note) 0-99</li> <li>(XPath KnitClothOrder/KCCObody/KCCOitem/apparelComponent/garmentPartComponent/note) 0-99</li> <li>(XPath KnitClothOrder/KCCObody/KCCOitem/phase/note) 0-99</li> <li>(XPath KnitClothOrder/KCCObody/KCCOitem/apparelProd/note) 0-99</li> <li>(XPath KnitClothOrder/terms/allowanceCharge/dtScheme/note) 0-99</li> <li>(XPath KnitClothOrder/KCCObody/KCCOitem/packages/handlingChar/note) 0-99</li> <li>(XPath KnitClothOrder/garComInfo/note) 0-99</li> </ul>
@noteLabel	<p>subject qualifier of a note</p> <ul style="list-style-type: none"> <li>- base type: string, max length: 35,</li> <li>(XPath KnitClothOrder/KCCObody/KCCOitem/apparelComponent/garmentPartComponent/note/@noteLabel) [Optional]</li> <li>- nota: <i>must be used to qualify the subject of the note</i></li> <li>(XPath KnitClothOrder/KCCObody/KCCOitem/apparelComponent/fabricComponent/note/@noteLabel) [Optional]</li> <li>- nota: <i>must be used to qualify the subject of the note</i></li> <li>(XPath KnitClothOrder/KCCObody/KCCOitem/garComInfo/note/@noteLabel) [Optional]</li> <li>- nota: <i>must be used to qualify the subject of the note</i></li> <li>(XPath KnitClothOrder/terms/allowanceCharge/dtScheme/note/@noteLabel) [Optional]</li> <li>- nota: <i>must be used to qualify the subject of the note</i></li> <li>(XPath KnitClothOrder/KCCObody/KCCOitem/phase/packages/handlingChar/note/@noteLabel) [Optional]</li> <li>- nota: <i>must be used to qualify the subject of the note</i></li> <li>(XPath KnitClothOrder/KCCObody/KCCOitem/phase/note/@noteLabel) [Optional]</li> <li>- nota: <i>must be used to qualify the subject of the note</i></li> <li>(XPath KnitClothOrder/KCCObody/KCCOitem/apparelComponent/yarnComponent/note/@noteLabel) [Optional]</li> <li>- nota: <i>must be used to qualify the subject of the note</i></li> <li>(XPath KnitClothOrder/KCCObody/KCCOitem/packages/handlingChar/note/@noteLabel) [Optional]</li> <li>- nota: <i>must be used to qualify the subject of the note</i></li> <li>(XPath KnitClothOrder/KCCObody/KCCOitem/apparelProd/note/@noteLabel) [Optional]</li> </ul>

	<ul style="list-style-type: none"> <li>- nota: <i>must be used to qualify the subject of the note</i> (XPath KnitClothOrder/KCCObody/KCCOitem/appMnfrOperation/ note/@noteLabel) [Optional]</li> <li>- nota: <i>must be used to qualify the subject of the note</i> (XPath KnitClothOrder/KCCObody/KCCOitem/note/@noteLabel) [Optional]</li> <li>- nota: <i>must be used to qualify the subject of the note</i> (XPath KnitClothOrder/KCCOheader/note/@noteLabel) [Optional]</li> <li>- nota: <i>must be used to qualify the subject of the note</i> (XPath KnitClothOrder/KCCObody/KCCOitem/apparelComponent/ acsComponent/note/@noteLabel) [Optional]</li> <li>- nota: <i>must be used to qualify the subject of the note</i> (XPath KnitClothOrder/KCCObody/KCCOitem/dtScheme/note/@noteLabel) [Optional]</li> <li>- nota: <i>must be used to qualify the subject of the note</i> (XPath KnitClothOrder/garComInfo/note/@noteLabel) [Optional]</li> <li>- nota: <i>must be used to qualify the subject of the note</i></li> </ul>
<p>@numberingOrg</p>	<p>code specifying the organisation who has created or owns the coding or numbering system</p> <ul style="list-style-type: none"> <li>- base type: string, cod. table: NT6 <a href="http://www.ebiz.enea.it/moda-ml/repository/codelist/draft/gc_NT6.xml">http://www.ebiz.enea.it/moda-ml/repository/codelist/draft/gc_NT6.xml</a> (XPath KnitClothOrder/KCCObody/KCCOitem/phase/packages/ packageN/@numberingOrg) [Optional]</li> <li>(XPath KnitClothOrder/KCCObody/KCCOitem/phase/packages/ EPClist/EPC/@numberingOrg) [Optional]</li> <li>(XPath KnitClothOrder/KCCObody/KCCOitem/phase/packages/ handlingChar/note/@numberingOrg) [Optional]</li> <li>(XPath KnitClothOrder/KCCObody/KCCOitem/phase/refDoc/ attachment/fileName/@numberingOrg) [Optional]</li> <li>(XPath KnitClothOrder/KCCObody/KCCOitem/phase/note/@numberingOrg) [Optional]</li> <li>(XPath KnitClothOrder/KCCObody/KCCOitem/phase/garConsumptionSet/acsCode/ art/@numberingOrg) [Optional]</li> <li>- nota: <i>this attribute should be used either single or coupled with "listName" and "listVersion"</i> (XPath KnitClothOrder/KCCObody/KCCOitem/phase/garConsumptionSet/acsCode/ @numberingOrg) [Optional]</li> <li>(XPath KnitClothOrder/KCCObody/KCCOitem/phase/garConsumptionSet/garmentP artCode/mod/@numberingOrg) [Optional]</li> <li>- nota: <i>this attribute should be ALTERNATIVE to the others</i> (XPath KnitClothOrder/KCCObody/KCCOitem/phase/garConsumptionSet/yarnCode/ added/@numberingOrg) [Optional]</li> <li>(XPath KnitClothOrder/KCCObody/KCCOitem/phase/garConsumptionSet/garmentP artCode/@numberingOrg) [Optional]</li> <li>(XPath KnitClothOrder/KCCObody/KCCOitem/phase/garConsumptionSet/garmentP artCode/added/@numberingOrg) [Optional]</li> <li>(XPath KnitClothOrder/KCCObody/KCCOitem/phase/garConsumptionSet/garmentC ode/@numberingOrg) [Optional]</li> <li>(XPath KnitClothOrder/KCCObody/KCCOitem/phase/garConsumptionSet/garmentP artCode/color/@numberingOrg) [Optional]</li> <li>- nota: <i>this attribute should be used either single or coupled with "listName" and "listVersion"</i> (XPath KnitClothOrder/KCCObody/KCCOitem/phase/garConsumptionSet/garmentP artCode/fabric/@numberingOrg) [Optional]</li> <li>- nota: <i>this attribute should be used either single or coupled with "listName" and "listVersion"</i> (XPath KnitClothOrder/KCCObody/KCCOitem/note/@numberingOrg) [Optional]</li> </ul>

(XPath KnitClothOrder/KCCObody/KCCOitem/phase/garConsumptionSet/yarnCode/color/@numberingOrg) [Optional]  
- nota: *this attribute should be used either single or coupled with "listName" and "listVersion"*

(XPath KnitClothOrder/KCCObody/KCCOitem/phase/garConsumptionSet/texCode/pattern/@numberingOrg) [Optional]  
- nota: *this attribute should be used either single or coupled with "listName" and "listVersion"*

(XPath KnitClothOrder/KCCObody/KCCOitem/phase/garConsumptionSet/acsCode/color/@numberingOrg) [Optional]  
- nota: *this attribute should be used either single or coupled with "listName" and "listVersion"*

(XPath KnitClothOrder/KCCObody/KCCOitem/phase/garConsumptionSet/texCode/art/@numberingOrg) [Optional]  
- nota: *this attribute should be used either single or coupled with "listName" and "listVersion"*

(XPath KnitClothOrder/KCCObody/KCCOitem/phase/garConsumptionSet/acsCode/added/@numberingOrg) [Optional]

(XPath KnitClothOrder/KCCObody/KCCOitem/phase/garConsumptionSet/texCode/@numberingOrg) [Optional]

(XPath KnitClothOrder/KCCObody/KCCOitem/phase/garConsumptionSet/yarnCode/@numberingOrg) [Optional] [Default= CL]

(XPath KnitClothOrder/KCCObody/KCCOitem/phase/garConsumptionSet/yarnCode/art/@numberingOrg) [Optional]  
- nota: *this attribute should be used either single or coupled with "listName" and "listVersion"*

(XPath KnitClothOrder/KCCObody/KCCOitem/phase/garConsumptionSet/acsCode/pattern/@numberingOrg) [Optional]  
- nota: *this attribute should be used either single or coupled with "listName" and "listVersion"*

(XPath KnitClothOrder/KCCObody/KCCOitem/phase/garConsumptionSet/texCode/color/@numberingOrg) [Optional]  
- nota: *this attribute should be used either single or coupled with "listName" and "listVersion"*

(XPath KnitClothOrder/KCCObody/KCCOitem/phase/garConsumptionSet/texCode/added/@numberingOrg) [Optional]

(XPath KnitClothOrder/KCCObody/KCCOitem/phase/garConsumptionSet/garConsumption/@numberingOrg) [Optional]  
- nota: *to be used for garSizeCode*

(XPath KnitClothOrder/KCCObody/KCCOitem/garComInfo/operationalCode/@numberingOrg) [Optional]

(XPath KnitClothOrder/KCCObody/KCCOitem/phase/garConsumptionSet/dyeN/@numberingOrg) [Optional]

(XPath KnitClothOrder/KCCObody/KCCOitem/phase/garConsumptionSet/garmentCode/garmentCodeA/art/@numberingOrg) [Optional]  
- nota: *this attribute should be used either single or coupled with "listName" and "listVersion"*

(XPath KnitClothOrder/KCCObody/KCCOitem/phase/garConsumptionSet/lotN/@numberingOrg) [Optional]

(XPath KnitClothOrder/KCCObody/KCCOitem/garComInfo/brand/@numberingOrg) [Optional]

(XPath KnitClothOrder/KCCObody/KCCOitem/garComInfo/season/@numberingOrg) [Optional]

(XPath KnitClothOrder/KCCObody/KCCOitem/garComInfo/productLine/@numberingOrg) [Optional]

(XPath KnitClothOrder/KCCOheader/docID/@numberingOrg) [Optional]

- nota: *here can be specified whose document numbering is used (e.g.: Client, Supplier, ..)*

(XPath KnitClothOrder/KCCObody/KCCOitem/phase/packages/packageModelCode/@numberingOrg) [Optional]

(XPath KnitClothOrder/KCCObody/KCCOitem/garComInfo/note/@numberingOrg) [Optional]

(XPath KnitClothOrder/KCCObody/KCCOitem/phase/garConsumptionSet/garmentCode/garmentCodeB/fabric/@numberingOrg) [Optional]

- nota: *this attribute should be used either single or coupled with "listName" and "listVersion"*

(XPath KnitClothOrder/KCCObody/KCCOitem/phase/thirdParty/id/@numberingOrg) [Optional]

(XPath KnitClothOrder/KCCObody/KCCOitem/phase/garConsumptionSet/garmentCode/garmentCodeB/mod/@numberingOrg) [Optional]

- nota: *this attribute should be ALTERNATIVE to the others*

(XPath KnitClothOrder/KCCOheader/season/@numberingOrg) [Optional]

(XPath KnitClothOrder/KCCObody/KCCOitem/phase/garConsumptionSet/garmentCode/garmentCodeB/@numberingOrg) [Optional]

(XPath KnitClothOrder/KCCObody/KCCOitem/phase/garConsumptionSet/garmentCode/garmentCodeB/artGroup/@numberingOrg) [Optional]

- nota: *this attribute should be used either single or coupled with "listName" and "listVersion"*

(XPath KnitClothOrder/KCCObody/KCCOitem/phase/garConsumptionSet/garmentCode/garmentCodeB/added/@numberingOrg) [Optional]

(XPath KnitClothOrder/KCCObody/KCCOitem/phase/garConsumptionSet/garmentCode/garmentCodeB/garmentVariant/variantCode/@numberingOrg) [Optional]

- nota: *this attribute should be used either single or coupled with "listName" and "listVersion"*

(XPath KnitClothOrder/KCCObody/KCCOitem/phase/garConsumptionSet/garmentCode/garmentCodeB/color/@numberingOrg) [Optional]

- nota: *this attribute should be used either single or coupled with "listName" and "listVersion"*

(XPath KnitClothOrder/KCCObody/KCCOitem/phase/garConsumptionSet/garmentCode/garmentCodeB/garmentVariant/variantType/@numberingOrg) [Optional]

- nota: *this attribute should be used either single or coupled with "listName" and "listVersion"*

(XPath KnitClothOrder/KCCObody/KCCOitem/phase/refDoc/season/@numberingOrg) [Optional]

(XPath KnitClothOrder/KCCObody/KCCOitem/garTecSheet/garConsumptionSet/garmentCode/garmentCodeB/added/@numberingOrg) [Optional]

(XPath KnitClothOrder/KCCObody/KCCOitem/garTecSheet/garConsumptionSet/garmentCode/garmentCodeA/art/@numberingOrg) [Optional]

- nota: *this attribute should be used either single or coupled with "listName" and "listVersion"*

(XPath KnitClothOrder/KCCObody/KCCOitem/garTecSheet/garConsumptionSet/garmentCode/garmentCodeB/artGroup/@numberingOrg) [Optional]

- nota: *this attribute should be used either single or coupled with "listName" and "listVersion"*

(XPath KnitClothOrder/KCCObody/KCCOitem/apparelProd/dyeN/@numberingOrg) [Optional]

(XPath KnitClothOrder/KCCObody/KCCOitem/garTecSheet/garConsumptionSet/garmentCode/garmentCodeB/garmentVariant/variantCode/@numberingOrg) [Optional]  
- nota: *this attribute should be used either single or coupled with “listName” and “listVersion”*

(XPath KnitClothOrder/KCCObody/KCCOitem/garTecSheet/garConsumptionSet/garConsumption/@numberingOrg) [Optional]  
- nota: *to be used for garSizeCode*

(XPath KnitClothOrder/KCCObody/KCCOitem/apparelProd/lotN/@numberingOrg) [Optional]  
(XPath KnitClothOrder/KCCOheader/subContractor/id/@numberingOrg) [Optional]  
(XPath KnitClothOrder/KCCObody/KCCOitem/garTecSheet/garConsumptionSet/lotN/@numberingOrg) [Optional]  
(XPath KnitClothOrder/KCCObody/KCCOitem/garTecSheet/garConsumptionSet/dyeN/@numberingOrg) [Optional]  
(XPath KnitClothOrder/KCCObody/KCCOitem/garTecSheet/garConsumptionSet/garmentCode/garmentCodeB/garmentVariant/variantType/@numberingOrg) [Optional]  
- nota: *this attribute should be used either single or coupled with “listName” and “listVersion”*

(XPath KnitClothOrder/KCCObody/KCCOitem/garTecSheet/garConsumptionSet/garmentPartCode/added/@numberingOrg) [Optional]  
(XPath KnitClothOrder/KCCObody/KCCOitem/garTecSheet/garConsumptionSet/garmentCode/@numberingOrg) [Optional]  
(XPath KnitClothOrder/KCCObody/KCCOitem/garTecSheet/garConsumptionSet/garmentPartCode/color/@numberingOrg) [Optional]  
- nota: *this attribute should be used either single or coupled with “listName” and “listVersion”*

(XPath KnitClothOrder/KCCObody/KCCOitem/garTecSheet/garConsumptionSet/garmentPartCode/mod/@numberingOrg) [Optional]  
- nota: *this attribute should be ALTERNATIVE to the others*

(XPath KnitClothOrder/KCCObody/KCCOitem/garTecSheet/garConsumptionSet/garmentPartCode/fabric/@numberingOrg) [Optional]  
- nota: *this attribute should be used either single or coupled with “listName” and “listVersion”*

(XPath KnitClothOrder/KCCObody/KCCOitem/garTecSheet/garConsumptionSet/garmentCode/garmentCodeB/color/@numberingOrg) [Optional]  
- nota: *this attribute should be used either single or coupled with “listName” and “listVersion”*

(XPath KnitClothOrder/KCCObody/KCCOitem/endUseGroup/csRange/sizeMatrix/sizeRow/itemsList/itemIdentification/serialN/@numberingOrg) [Optional]  
- nota: *here the issuer of the serial number must be specified (when different from the Supplier)*

(XPath KnitClothOrder/KCCObody/KCCOitem/garTecSheet/garConsumptionSet/garmentCode/garmentCodeB/fabric/@numberingOrg) [Optional]  
- nota: *this attribute should be used either single or coupled with “listName” and “listVersion”*

(XPath KnitClothOrder/KCCObody/KCCOitem/garTecSheet/garConsumptionSet/garmentCode/garmentCodeB/@numberingOrg) [Optional]  
(XPath KnitClothOrder/KCCObody/KCCOitem/garTecSheet/garConsumptionSet/garmentCode/garmentCodeB/mod/@numberingOrg) [Optional]  
- nota: *this attribute should be ALTERNATIVE to the others*

(XPath KnitClothOrder/KCCObody/KCCOitem/apparelProd/garmentCode/garmentCodeA/art/@numberingOrg) [Optional]  
- nota: *this attribute should be used either single or coupled with “listName” and “listVersion”*

(XPath KnitClothOrder/KCCObody/KCCOitem/apparelProd/garmentCode/garmentCodeB/color/@numberingOrg) [Optional]  
- nota: *this attribute should be used either single or coupled with “listName” and “listVersion”*

(XPath KnitClothOrder/KCCObody/KCCOitem/apparelComponent/yarnComponent/refDoc/season/@numberingOrg) [Optional]

(XPath KnitClothOrder/KCCObody/KCCOitem/apparelComponent/yarnComponent/refDoc/docID/@numberingOrg) [Optional]

- nota: *here can be specified whose document numbering is used (e.g.: Client, Supplier, ..)*

(XPath KnitClothOrder/KCCObody/KCCOitem/apparelComponent/yarnComponent/lotN/@numberingOrg) [Optional]

(XPath KnitClothOrder/KCCObody/KCCOitem/apparelComponent/yarnComponent/dyeN/@numberingOrg) [Optional]

(XPath KnitClothOrder/KCCObody/KCCOitem/dtScheme/note/@numberingOrg) [Optional]

(XPath KnitClothOrder/KCCObody/KCCOitem/apparelComponent/fabricComponent/texCode/@numberingOrg) [Optional]

(XPath KnitClothOrder/KCCObody/KCCOitem/apparelComponent/yarnComponent/note/@numberingOrg) [Optional]

(XPath KnitClothOrder/KCCObody/KCCOitem/apparelProd/garmentCode/garmentCodeB/fabric/@numberingOrg) [Optional]

- nota: *this attribute should be used either single or coupled with "listName" and "listVersion"*

(XPath KnitClothOrder/KCCObody/KCCOitem/apparelComponent/yarnComponent/refDoc/attachment/fileName/@numberingOrg) [Optional]

(XPath KnitClothOrder/KCCObody/KCCOitem/apparelComponent/yarnComponent/yarnCode/added/@numberingOrg) [Optional]

(XPath KnitClothOrder/KCCObody/KCCOitem/apparelProd/garmentCode/garmentCodeB/garmentVariant/variantCode/@numberingOrg) [Optional]

- nota: *this attribute should be used either single or coupled with "listName" and "listVersion"*

(XPath KnitClothOrder/KCCObody/KCCOitem/progress/itemsList/qualityLevel/@numberingOrg) [Optional]

(XPath KnitClothOrder/KCCObody/KCCOitem/apparelProd/garmentCode/garmentCodeB/artGroup/@numberingOrg) [Optional]

- nota: *this attribute should be used either single or coupled with "listName" and "listVersion"*

(XPath KnitClothOrder/KCCObody/KCCOitem/endUseGroup/csRange/sizeMatrix/sizeRow/itemsList/qualityLevel/@numberingOrg) [Optional]

(XPath KnitClothOrder/KCCObody/KCCOitem/apparelProd/garmentCode/garmentCodeB/added/@numberingOrg) [Optional]

(XPath KnitClothOrder/KCCObody/KCCOitem/apparelComponent/yarnComponent/yarnCode/art/@numberingOrg) [Optional]

- nota: *this attribute should be used either single or coupled with "listName" and "listVersion"*

(XPath KnitClothOrder/KCCObody/KCCOitem/apparelComponent/yarnComponent/yarnCode/color/@numberingOrg) [Optional]

- nota: *this attribute should be used either single or coupled with "listName" and "listVersion"*

(XPath KnitClothOrder/KCCObody/KCCOitem/apparelComponent/yarnComponent/yarnCode/@numberingOrg) [Optional] [Default= CL]

(XPath KnitClothOrder/KCCObody/KCCOitem/apparelProd/garmentCode/garmentCodeB/garmentVariant/variantType/@numberingOrg) [Optional]

- nota: *this attribute should be used either single or coupled with "listName" and "listVersion"*

(XPath KnitClothOrder/KCCObody/KCCOitem/progress/itemsList/itemIdentification/serialN/@numberingOrg) [Optional]

- nota: *here the issuer of the serial number must be specified (when different from the Supplier)*

(XPath KnitClothOrder/KCCObody/KCCOitem/garTecSheet/garmentCode/garmentCodeB/added/@numberingOrg) [Optional]

(XPath KnitClothOrder/KCCObody/KCCOitem/apparelProd/csRange/sizeMatrix/sizeRow/additionalComponentCode/@numberingOrg) [Optional]

(XPath KnitClothOrder/KCCObody/KCCOitem/garTecSheet/garmentCode/garmentCodeB/artGroup/@numberingOrg) [Optional]

- nota: *this attribute should be used either single or coupled with "listName" and "listVersion"*  
 (XPath KnitClothOrder/KCCObody/KCCOitem/garTecSheet/  
 garmentCode/garmentCodeB/garmentVariant/variantType/@numberingOrg)  
 [Optional]

- nota: *this attribute should be used either single or coupled with "listName" and "listVersion"*  
 (XPath KnitClothOrder/KCCObody/KCCOitem/garTecSheet/  
 garmentCode/garmentCodeB/garmentVariant/variantCode/@numberingOrg)  
 [Optional]

- nota: *this attribute should be used either single or coupled with "listName" and "listVersion"*  
 (XPath KnitClothOrder/KCCObody/KCCOitem/garTecSheet/  
 refDoc/season/@numberingOrg) [Optional]  
 (XPath KnitClothOrder/KCCObody/KCCOitem/garTecSheet/  
 refDoc/attachment/fileName/@numberingOrg) [Optional]  
 (XPath KnitClothOrder/KCCObody/KCCOitem/apparelProd/  
 csRange/garmentVariant/variantCode/@numberingOrg) [Optional]

- nota: *this attribute should be used either single or coupled with "listName" and "listVersion"*  
 (XPath KnitClothOrder/KCCObody/KCCOitem/garTecSheet/  
 garmentCode/garmentCodeA/art/@numberingOrg) [Optional]

- nota: *this attribute should be used either single or coupled with "listName" and "listVersion"*  
 (XPath KnitClothOrder/KCCObody/KCCOitem/garTecSheet/  
 refDoc/docID/@numberingOrg) [Optional]

- nota: *here can be specified whose document numbering is used (e.g.: Client, Supplier, ..)*  
 (XPath KnitClothOrder/KCCObody/KCCOitem/garTecSheet/  
 garmentCode/garmentCodeB/color/@numberingOrg) [Optional]

- nota: *this attribute should be used either single or coupled with "listName" and "listVersion"*  
 (XPath KnitClothOrder/KCCObody/KCCOitem/apparelProd/  
 csRange/sizeMatrix/sizeRow/itemsList/qualityLevel/@numberingOrg) [Optional]

(XPath KnitClothOrder/KCCOheader/note/@numberingOrg) [Optional]  
 (XPath KnitClothOrder/KCCObody/KCCOitem/thirdParty/id/@numberingOrg) [Optional]

(XPath KnitClothOrder/KCCObody/KCCOitem/apparelProd/note/@numberingOrg) [Optional]  
 (XPath KnitClothOrder/KCCObody/KCCOitem/apparelProd/  
 csRange/sizeMatrix/sizeRow/itemsList/itemIdentification/serialN/@numberingOrg) [Optional]

- nota: *here the issuer of the serial number must be specified (when different from the Supplier)*  
 (XPath KnitClothOrder/KCCObody/KCCOitem/garTecSheet/  
 garmentCode/garmentCodeB/mod/@numberingOrg) [Optional]

- nota: *this attribute should be ALTERNATIVE to the others*  
 (XPath KnitClothOrder/KCCObody/KCCOitem/garTecSheet/  
 garmentCode/garmentCodeB/fabric/@numberingOrg) [Optional]

- nota: *this attribute should be used either single or coupled with "listName" and "listVersion"*  
 (XPath KnitClothOrder/KCCObody/KCCOitem/garTecSheet/  
 garmentCode/garmentCodeB/@numberingOrg) [Optional]  
 (XPath KnitClothOrder/KCCObody/KCCOitem/packages/packageN/@numberingOrg) [Optional]  
 (XPath KnitClothOrder/KCCObody/KCCOitem/garTecSheet/  
 garmentCode/@numberingOrg) [Optional]  
 (XPath KnitClothOrder/KCCOheader/thirdParty/id/@numberingOrg) [Optional]  
 (XPath KnitClothOrder/KCCObody/KCCOitem/garTecSheet/  
 garConsumptionSet/texCode/color/@numberingOrg) [Optional]

- nota: *this attribute should be used either single or coupled with "listName" and "listVersion"*  
 (XPath KnitClothOrder/KCCObody/KCCOitem/garTecSheet/  
 garConsumptionSet/texCode/added/@numberingOrg) [Optional]



(XPath KnitClothOrder/KCCObody/KCCOitem/garTecSheet/  
garConsumptionSet/texCode/pattern/@numberingOrg) [Optional]  
- nota: *this attribute should be used either single or coupled with "listName" and "listVersion"*

(XPath KnitClothOrder/KCCObody/KCCOitem/garTecSheet/  
garConsumptionSet/texCode/@numberingOrg) [Optional]

(XPath KnitClothOrder/KCCObody/KCCOitem/garTecSheet/  
garConsumptionSet/texCode/art/@numberingOrg) [Optional]  
- nota: *this attribute should be used either single or coupled with "listName" and "listVersion"*

(XPath KnitClothOrder/KCCObody/KCCOitem/garTecSheet/  
garConsumptionSet/yarnCode/added/@numberingOrg) [Optional]

(XPath KnitClothOrder/KCCObody/KCCOitem/garTecSheet/  
garConsumptionSet/garmentPartCode/@numberingOrg) [Optional]

(XPath KnitClothOrder/KCCObody/KCCOitem/garTecSheet/  
garConsumptionSet/yarnCode/color/@numberingOrg) [Optional]  
- nota: *this attribute should be used either single or coupled with "listName" and "listVersion"*

(XPath KnitClothOrder/KCCObody/KCCOitem/garTecSheet/  
garConsumptionSet/yarnCode/@numberingOrg) [Optional] [Default= CL]

(XPath KnitClothOrder/KCCObody/KCCOitem/garTecSheet/  
garConsumptionSet/yarnCode/art/@numberingOrg) [Optional]  
- nota: *this attribute should be used either single or coupled with "listName" and "listVersion"*

(XPath KnitClothOrder/KCCObody/KCCOitem/garTecSheet/  
garConsumptionSet/acsCode/added/@numberingOrg) [Optional]

(XPath KnitClothOrder/KCCObody/KCCOitem/apparelProd/  
csRange/color/@numberingOrg) [Optional]  
- nota: *this attribute should be used either single or coupled with "listName" and "listVersion"*

(XPath KnitClothOrder/KCCObody/KCCOitem/apparelProd/  
csRange/@numberingOrg) [Optional]

(XPath KnitClothOrder/KCCObody/KCCOitem/packages/  
packageModelCode/@numberingOrg) [Optional]

(XPath KnitClothOrder/KCCObody/KCCOitem/garTecSheet/  
garSizeSet/@numberingOrg) [Optional]

(XPath KnitClothOrder/KCCObody/KCCOitem/apparelProd/  
csRange/garmentVariant/variantType/@numberingOrg) [Optional]  
- nota: *this attribute should be used either single or coupled with "listName" and "listVersion"*

(XPath KnitClothOrder/KCCObody/KCCOitem/garTecSheet/  
garConsumptionSet/acsCode/pattern/@numberingOrg) [Optional]  
- nota: *this attribute should be used either single or coupled with "listName" and "listVersion"*

(XPath KnitClothOrder/KCCObody/KCCOitem/garTecSheet/  
garConsumptionSet/acsCode/color/@numberingOrg) [Optional]  
- nota: *this attribute should be used either single or coupled with "listName" and "listVersion"*

(XPath KnitClothOrder/KCCObody/KCCOitem/garTecSheet/  
garConsumptionSet/acsCode/art/@numberingOrg) [Optional]  
- nota: *this attribute should be used either single or coupled with "listName" and "listVersion"*

(XPath KnitClothOrder/KCCObody/KCCOitem/packages/  
EPClist/EPC/@numberingOrg) [Optional]

(XPath KnitClothOrder/KCCObody/KCCOitem/garTecSheet/  
garConsumptionSet/acsCode/@numberingOrg) [Optional]

(XPath KnitClothOrder/KCCObody/KCCOitem/apparelComponent/  
acsComponent/note/@numberingOrg) [Optional]

(XPath KnitClothOrder/garComInfo/note/@numberingOrg) [Optional]

(XPath KnitClothOrder/KCCObody/KCCOitem/apparelComponent/  
acsComponent/refDoc/attachment/fileName/@numberingOrg) [Optional]

(XPath KnitClothOrder/KCCObody/KCCOitem/apparelProd/  
garmentPartCode/@numberingOrg) [Optional]

(XPath KnitClothOrder/KCCObody/KCCOitem/apparelComponent/  
acsComponent/refDoc/season/@numberingOrg) [Optional]

(XPath KnitClothOrder/garComInfo/productLine/@numberingOrg) [Optional]

(XPath KnitClothOrder/KCCObody/KCCOitem/appMnfrOperation/refDoc/attachment/fileName/@numberingOrg) [Optional]

(XPath KnitClothOrder/KCCObody/KCCOitem/appMnfrOperation/refDoc/season/@numberingOrg) [Optional]

(XPath KnitClothOrder/garComInfo/operationalCode/@numberingOrg) [Optional]

(XPath KnitClothOrder/KCCObody/KCCOitem/appMnfrOperation/refDoc/docID/@numberingOrg) [Optional]

- nota: *here can be specified whose document numbering is used (e.g.: Client, Supplier, ..)*

(XPath KnitClothOrder/KCCObody/KCCOitem/apparelComponent/acsComponent/acsCode/added/@numberingOrg) [Optional]

(XPath KnitClothOrder/KCCObody/KCCOitem/apparelComponent/acsComponent/lotN/@numberingOrg) [Optional]

(XPath KnitClothOrder/KCCObody/KCCOitem/apparelComponent/acsComponent/acsCode/color/@numberingOrg) [Optional]

- nota: *this attribute should be used either single or coupled with "listName" and "listVersion"*

(XPath KnitClothOrder/KCCObody/KCCOitem/apparelComponent/acsComponent/acsCode/pattern/@numberingOrg) [Optional]

- nota: *this attribute should be used either single or coupled with "listName" and "listVersion"*

(XPath KnitClothOrder/KCCObody/KCCOitem/apparelProd/garmentPartCode/color/@numberingOrg) [Optional]

- nota: *this attribute should be used either single or coupled with "listName" and "listVersion"*

(XPath KnitClothOrder/KCCObody/KCCOitem/endUseGroup/csRange/garmentVariant/variantCode/@numberingOrg) [Optional]

- nota: *this attribute should be used either single or coupled with "listName" and "listVersion"*

(XPath KnitClothOrder/KCCObody/KCCOitem/apparelComponent/acsComponent/refDoc/docID/@numberingOrg) [Optional]

- nota: *here can be specified whose document numbering is used (e.g.: Client, Supplier, ..)*

(XPath KnitClothOrder/KCCObody/KCCOitem/apparelProd/garmentPartCode/mod/@numberingOrg) [Optional]

- nota: *this attribute should be ALTERNATIVE to the others*

(XPath KnitClothOrder/KCCObody/KCCOitem/apparelComponent/acsComponent/dyeN/@numberingOrg) [Optional]

(XPath KnitClothOrder/KCCObody/KCCOitem/apparelProd/garmentPartCode/fabric/@numberingOrg) [Optional]

- nota: *this attribute should be used either single or coupled with "listName" and "listVersion"*

(XPath KnitClothOrder/garComInfo/brand/@numberingOrg) [Optional]

(XPath KnitClothOrder/KCCOheader/refDoc/season/@numberingOrg) [Optional]

(XPath KnitClothOrder/KCCObody/KCCOitem/phase/lotDetails/csRange/sizeMatrix/sizeRow/additionalComponentCode/@numberingOrg) [Optional]

(XPath KnitClothOrder/KCCObody/KCCOitem/phase/lotDetails/csRange/garmentVariant/variantCode/@numberingOrg) [Optional]

- nota: *this attribute should be used either single or coupled with "listName" and "listVersion"*

(XPath KnitClothOrder/KCCObody/KCCOitem/endUseGroup/csRange/@numberingOrg) [Optional]

(XPath KnitClothOrder/KCCObody/KCCOitem/phase/lotDetails/csRange/garmentVariant/variantType/@numberingOrg) [Optional]

- nota: *this attribute should be used either single or coupled with "listName" and "listVersion"*

(XPath KnitClothOrder/KCCObody/KCCOitem/phase/lotDetails/csRange/sizeMatrix/sizeRow/itemsList/itemIdentification/serialN/@numberingOrg) [Optional]

- nota: *here the issuer of the serial number must be specified (when different from the Supplier)*

(XPath KnitClothOrder/KCCObody/KCCOitem/phase/refDoc/docID/@numberingOrg) [Optional]

- nota: *here can be specified whose document numbering is used (e.g.: Client, Supplier, ..)*  
(XPath KnitClothOrder/KCCOheader/refDoc/docID/@numberingOrg) [Optional]

- nota: *here can be specified whose document numbering is used (e.g.: Client, Supplier, ..)*  
(XPath KnitClothOrder/KCCObody/KCCOitem/packages/handlingChar/note/@numberingOrg) [Optional]  
(XPath KnitClothOrder/KCCObody/KCCOitem/phase/lotDetails/csRange/sizeMatrix/sizeRow/itemsList/qualityLevel/@numberingOrg) [Optional]

(XPath KnitClothOrder/garComInfo/season/@numberingOrg) [Optional]  
(XPath KnitClothOrder/KCCObody/KCCOitem/phase/phaseCode/@numberingOrg) [Optional]

(XPath KnitClothOrder/KCCObody/KCCOitem/appMnfrOperation/note/@numberingOrg) [Optional]  
(XPath KnitClothOrder/KCCOheader/refDoc/attachment/fileName/@numberingOrg) [Optional]  
(XPath KnitClothOrder/KCCObody/KCCOitem/endUseGroup/csRange/garmentVariant/variantType/@numberingOrg) [Optional]

- nota: *this attribute should be used either single or coupled with "listName" and "listVersion"*  
(XPath KnitClothOrder/KCCObody/KCCOitem/endUseGroup/csRange/color/@numberingOrg) [Optional]

- nota: *this attribute should be used either single or coupled with "listName" and "listVersion"*  
(XPath KnitClothOrder/KCCObody/KCCOitem/phase/lotDetails/csRange/color/@numberingOrg) [Optional]

- nota: *this attribute should be used either single or coupled with "listName" and "listVersion"*  
(XPath KnitClothOrder/KCCObody/KCCOitem/phase/lotDetails/csRange/@numberingOrg) [Optional]  
(XPath KnitClothOrder/KCCObody/KCCOitem/phase/lotDetails/lotN/@numberingOrg) [Optional]  
(XPath KnitClothOrder/terms/allowanceCharge/dtScheme/note/@numberingOrg) [Optional]

(XPath KnitClothOrder/KCCObody/KCCOitem/apparelComponent/fabricComponent/note/@numberingOrg) [Optional]  
(XPath KnitClothOrder/KCCObody/KCCOitem/apparelProd/garmentCode/@numberingOrg) [Optional]  
(XPath KnitClothOrder/KCCObody/KCCOitem/apparelProd/garmentCode/garmentCodeB/mod/@numberingOrg) [Optional]

- nota: *this attribute should be ALTERNATIVE to the others*  
(XPath KnitClothOrder/KCCObody/KCCOitem/apparelComponent/fabricComponent/refDoc/attachment/fileName/@numberingOrg) [Optional]  
(XPath KnitClothOrder/KCCObody/KCCOitem/apparelComponent/fabricComponent/texCode/added/@numberingOrg) [Optional]  
(XPath KnitClothOrder/KCCObody/KCCOitem/apparelComponent/garmentPartComponent/garmentPartCode/mod/@numberingOrg) [Optional]

- nota: *this attribute should be ALTERNATIVE to the others*  
(XPath KnitClothOrder/KCCObody/KCCOitem/apparelComponent/garmentPartComponent/garmentPartCode/fabric/@numberingOrg) [Optional]

- nota: *this attribute should be used either single or coupled with "listName" and "listVersion"*  
(XPath KnitClothOrder/KCCObody/KCCOitem/apparelComponent/fabricComponent/texCode/color/@numberingOrg) [Optional]

- nota: *this attribute should be used either single or coupled with "listName" and "listVersion"*  
(XPath KnitClothOrder/KCCObody/KCCOitem/apparelComponent/garmentPartComponent/garmentPartCode/@numberingOrg) [Optional]  
(XPath KnitClothOrder/KCCObody/KCCOitem/apparelComponent/fabricComponent/itemsList/itemIdentification/serialN/@numberingOrg) [Optional]

- nota: *here the issuer of the serial number must be specified (when different from the Supplier)*  
(XPath KnitClothOrder/KCCObody/KCCOitem/apparelComponent/fabricComponent/itemsList/qualityLevel/@numberingOrg) [Optional]

	<p>(XPath KnitClothOrder/KCCObody/KCCOitem/apparelComponent/fabricComponent/refDoc/docID/@numberingOrg) [Optional]</p> <p>- nota: <i>here can be specified whose document numbering is used (e.g.: Client, Supplier, ..)</i></p> <p>(XPath KnitClothOrder/KCCOheader/buyer/additionalIdentifier/@numberingOrg) [Optional]</p> <p>- nota: <i>here the issuer of the identifier must be specified</i></p> <p>(XPath KnitClothOrder/KCCObody/KCCOitem/apparelProd/garmentCode/garmentCodeB/@numberingOrg) [Optional]</p> <p>(XPath KnitClothOrder/KCCOheader/buyer/id/@numberingOrg) [Optional]</p> <p>(XPath KnitClothOrder/KCCObody/KCCOitem/endUseGroup/csRange/sizeMatrix/sizeRow/additionalComponentCode/@numberingOrg) [Optional]</p> <p>(XPath KnitClothOrder/KCCObody/KCCOitem/apparelComponent/fabricComponent/refDoc/season/@numberingOrg) [Optional]</p> <p>(XPath KnitClothOrder/KCCObody/KCCOitem/apparelComponent/fabricComponent/serialN/@numberingOrg) [Optional]</p> <p>- nota: <i>here the issuer of the serial number must be specified (when different from the Supplier)</i></p> <p>(XPath KnitClothOrder/KCCObody/KCCOitem/apparelComponent/garmentPartComponent/note/@numberingOrg) [Optional]</p> <p>(XPath KnitClothOrder/KCCObody/KCCOitem/apparelComponent/garmentPartComponent/refDoc/docID/@numberingOrg) [Optional]</p> <p>- nota: <i>here can be specified whose document numbering is used (e.g.: Client, Supplier, ..)</i></p> <p>(XPath KnitClothOrder/KCCObody/KCCOitem/apparelComponent/garmentPartComponent/refDoc/season/@numberingOrg) [Optional]</p> <p>(XPath KnitClothOrder/KCCObody/KCCOitem/apparelComponent/fabricComponent/texCode/art/@numberingOrg) [Optional]</p> <p>- nota: <i>this attribute should be used either single or coupled with "listName" and "listVersion"</i></p> <p>(XPath KnitClothOrder/KCCObody/KCCOitem/apparelComponent/acsComponent/acsCode/art/@numberingOrg) [Optional]</p> <p>- nota: <i>this attribute should be used either single or coupled with "listName" and "listVersion"</i></p> <p>(XPath KnitClothOrder/KCCObody/KCCOitem/apparelComponent/garmentPartComponent/refDoc/attachment/fileName/@numberingOrg) [Optional]</p> <p>(XPath KnitClothOrder/KCCObody/KCCOitem/apparelComponent/fabricComponent/texCode/pattern/@numberingOrg) [Optional]</p> <p>- nota: <i>this attribute should be used either single or coupled with "listName" and "listVersion"</i></p> <p>(XPath KnitClothOrder/KCCObody/KCCOitem/apparelComponent/garmentPartComponent/garmentPartCode/added/@numberingOrg) [Optional]</p> <p>(XPath KnitClothOrder/KCCObody/KCCOitem/apparelComponent/garmentPartComponent/garmentPartCode/color/@numberingOrg) [Optional]</p> <p>- nota: <i>this attribute should be used either single or coupled with "listName" and "listVersion"</i></p> <p>(XPath KnitClothOrder/KCCObody/KCCOitem/apparelComponent/acsComponent/acsCode/@numberingOrg) [Optional]</p> <p>(XPath KnitClothOrder/KCCObody/KCCOitem/apparelComponent/garmentPartComponent/dyeN/@numberingOrg) [Optional]</p> <p>(XPath KnitClothOrder/KCCObody/KCCOitem/apparelProd/garmentPartCode/added/@numberingOrg) [Optional]</p> <p>(XPath KnitClothOrder/KCCObody/KCCOitem/apparelComponent/garmentPartComponent/lotN/@numberingOrg) [Optional]</p>
operationalCode	<p>operational code: it is the code of a project, an event, an initiative, a sales channel, a management type (eg CITES), ... the document, or product, is connected with.</p> <p>- base type: string,</p> <p>(XPath KnitClothOrder/garComInfo/operationalCode) 0-19</p> <p>(XPath KnitClothOrder/KCCObody/KCCOitem/garComInfo/operationalCode) 0-19</p>

package	code specifying the type of transport package - base type: string, cod. table: T11 <a href="http://www.ebiz.enea.it/moda-ml/repository/codelist/draft/gc_T11.xml">http://www.ebiz.enea.it/moda-ml/repository/codelist/draft/gc_T11.xml</a> (XPath KnitClothOrder/KCCObody/KCCOitem/phase/packages/package) 1-1 (XPath KnitClothOrder/KCCObody/KCCOitem/packages/package) 1-1
@packageContainerN	reference usable to indicate the outer package containing this package - base type: string, max length: 40, (XPath KnitClothOrder/KCCObody/KCCOitem/phase/packages/packageN/@packageContainerN) [Optional] (XPath KnitClothOrder/KCCObody/KCCOitem/packages/packageN/@packageContainerN) [Optional]
@packageLevel	level used to indicate the hierarchical structure of the packages (from outer to inner levels) - base type: positiveInteger, min inclusive: 1, max inclusive: 9, (XPath KnitClothOrder/KCCObody/KCCOitem/packages/@packageLevel) [Optional] - nota: <i>number fixing the level of the package in the transport structure (from inner to outer). Must either be used for all package types or not be used</i> (XPath KnitClothOrder/KCCObody/KCCOitem/phase/packages/@packageLevel) [Optional] - nota: <i>number fixing the level of the package in the transport structure (from inner to outer). Must either be used for all package types or not be used</i>
packageModelCode	a code (eg a barcode) identifying the type of packaging - base type: string, (XPath KnitClothOrder/KCCObody/KCCOitem/phase/packages/packageModelCode) 0-1 (XPath KnitClothOrder/KCCObody/KCCOitem/packages/packageModelCode) 0-1
packageN	serial number used to identify a transport package - base type: string, max length: 40, (XPath KnitClothOrder/KCCObody/KCCOitem/phase/packages/packageN) 0-unbounded - note: <i>here the serial no.s of the packages can be identified</i> (XPath KnitClothOrder/KCCObody/KCCOitem/packages/packageN) 0-unbounded - note: <i>here the serial no.s of the packages can be identified</i>
packageQty	quantity of the specified transport packages - base type: positiveInteger, (XPath KnitClothOrder/KCCObody/KCCOitem/packages/packageQty) 0-1 - note: <i>total for the type of package</i> (XPath KnitClothOrder/KCCObody/KCCOitem/phase/packages/packageQty) 0-1 - note: <i>total for the type of package</i>
packageText	denomination of the type of transport package (text) - base type: string, max length: 80, (XPath KnitClothOrder/KCCObody/KCCOitem/packages/packageText) 1-1 (XPath KnitClothOrder/KCCObody/KCCOitem/phase/packages/packageText) 1-1
@part	percent fraction of a total payment - base type: decimal, min inclusive: 1, max inclusive: 99, fraction digits: 2, (XPath KnitClothOrder/terms/insPayment/@part) [Required] - nota: <i>here the % value of each installment must be indicated</i>
pattern	pattern/design number of the product, when not included in the article code - base type: string, max length: 15, (XPath KnitClothOrder/KCCObody/KCCOitem/garTecSheet/garConsumptionSet/acsCode/pattern) 0-1 (XPath KnitClothOrder/KCCObody/KCCOitem/phase/garConsumptionSet/acsCode/pattern) 0-1 (XPath KnitClothOrder/KCCObody/KCCOitem/apparelComponent/acsComponent/acsCode/pattern) 0-1 (XPath KnitClothOrder/KCCObody/KCCOitem/garTecSheet/garConsumptionSet/texCode/pattern) 0-1

	(XPath KnitClothOrder/KCCObody/KCCOitem/apparelComponent/fabricComponent/texCode/pattern) 0-1 (XPath KnitClothOrder/KCCObody/KCCOitem/phase/garConsumptionSet/texCode/pattern) 0-1
payMode	way or means of payment - base type: string, cod. table: T2 <a href="http://www.ebiz.enea.it/moda-ml/repository/codelist/draft/gc_T2.xml">http://www.ebiz.enea.it/moda-ml/repository/codelist/draft/gc_T2.xml</a> (XPath KnitClothOrder/terms/payment/payMode) 0-1 (XPath KnitClothOrder/terms/insPayment/payMode) 0-1
payTerm	code specifying the terms or time by which the payment must be done - base type: string, cod. table: T1 <a href="http://www.ebiz.enea.it/moda-ml/repository/codelist/draft/gc_T1.xml">http://www.ebiz.enea.it/moda-ml/repository/codelist/draft/gc_T1.xml</a> (XPath KnitClothOrder/terms/insPayment/payTerm) 1-1 (XPath KnitClothOrder/terms/payment/payTerm) 1-1
payTermText	free text specifying the terms by which the payment must be done (time/mode or means) - base type: string, max length: 250, (XPath KnitClothOrder/terms/insPayment/payTermText) 1-1 (XPath KnitClothOrder/terms/payment/payTermText) 1-1
pcQty	percent quantity of a raw material or of a specified component in a fabric or in a yarn - base type: decimal, min inclusive: 0, max inclusive: 100, fraction digits: 2, (XPath KnitClothOrder/KCCObody/KCCOitem/apparelComponent/yarnComponent/pcQty) 0-1 - note: <i>percentage of the component in the end product</i>
percCompos	fiber rate in the product composition - base type: decimal, min inclusive: 0, max inclusive: 100, fraction digits: 2, (XPath KnitClothOrder/KCCObody/KCCOitem/garTecSheet/fabricCompos/percCompos) 1-9
person	name of the contact person within a Party - base type: string, max length: 40, (XPath KnitClothOrder/KCCOheader/thirdParty/person) 0-1 (XPath KnitClothOrder/KCCOheader/subContractor/person) 0-1 (XPath KnitClothOrder/KCCObody/KCCOitem/phase/thirdParty/person) 0-1 (XPath KnitClothOrder/KCCOheader/buyer/person) 0-1 (XPath KnitClothOrder/KCCObody/KCCOitem/thirdParty/person) 0-1
phaseCode	Code that identifies a production phase of a fashion product. - base type: string, (XPath KnitClothOrder/KCCObody/KCCOitem/phase/phaseCode) 1-1
@phone	phone number of the contact person within a Party - base type: string, max length: 35, (XPath KnitClothOrder/KCCOheader/subContractor/person/@phone) [Optional] (XPath KnitClothOrder/KCCOheader/thirdParty/person/@phone) [Optional] (XPath KnitClothOrder/KCCObody/KCCOitem/thirdParty/person/@phone) [Optional] (XPath KnitClothOrder/KCCOheader/buyer/person/@phone) [Optional] (XPath KnitClothOrder/KCCObody/KCCOitem/phase/thirdParty/person/@phone) [Optional]
piecelnnWrap1	code specifying the type of inner wrapping/packing used for the fabric piece - base type: string, cod. table: T4 <a href="http://www.ebiz.enea.it/moda-ml/repository/codelist/draft/gc_T4.xml">http://www.ebiz.enea.it/moda-ml/repository/codelist/draft/gc_T4.xml</a> (XPath KnitClothOrder/KCCObody/KCCOitem/phase/packages/handlingChar/piecePack/piecelnnWrap1) 1-1 (XPath KnitClothOrder/KCCObody/KCCOitem/packages/handlingChar/piecePack/piecelnnWrap1) 1-1
piecelnnWrap2	code sub-specifying the type of inner wrapping/packing used for the fabric piece

	<p>- base type: string, cod. table: T5  <a href="http://www.ebiz.enea.it/moda-ml/repository/codelist/draft/gc_T5.xml">http://www.ebiz.enea.it/moda-ml/repository/codelist/draft/gc_T5.xml</a>  (XPath KnitClothOrder/KCCObody/KCCOitem/phase/packages/handlingChar/piecePack/pieceInnWrap2) 0-1  (XPath KnitClothOrder/KCCObody/KCCOitem/packages/handlingChar/piecePack/pieceInnWrap2) 0-1</p>
pieceOutWrap	<p>code specifying the type of outer wrapping or packing used for the fabric piece</p> <p>- base type: string, cod. table: T6  <a href="http://www.ebiz.enea.it/moda-ml/repository/codelist/draft/gc_T6.xml">http://www.ebiz.enea.it/moda-ml/repository/codelist/draft/gc_T6.xml</a>  (XPath KnitClothOrder/KCCObody/KCCOitem/phase/packages/handlingChar/piecePack/pieceOutWrap) 0-1  (XPath KnitClothOrder/KCCObody/KCCOitem/packages/handlingChar/piecePack/pieceOutWrap) 0-1</p>
piecePackText	<p>free text specifying the type of wrapping or packing used for the fabric piece</p> <p>- base type: string, max length: 250,  (XPath KnitClothOrder/KCCObody/KCCOitem/phase/packages/handlingChar/piecePack/piecePackText) 1-1  (XPath KnitClothOrder/KCCObody/KCCOitem/packages/handlingChar/piecePack/piecePackText) 1-1</p>
postCode	<p>code defining the postal zone</p> <p>- base type: string, max length: 10,  (XPath KnitClothOrder/KCCObody/KCCOitem/phase/thirdParty/postCode) 0-1  (XPath KnitClothOrder/KCCOheader/subContractor/postCode) 0-1  (XPath KnitClothOrder/KCCOheader/buyer/postCode) 0-1  (XPath KnitClothOrder/KCCObody/KCCOitem/thirdParty/postCode) 0-1  (XPath KnitClothOrder/KCCOheader/thirdParty/postCode) 0-1</p>
price	<p>unit price of the article, object or service specified</p> <p>- base type: decimal, min inclusive: 0, fraction digits: 4,  (XPath KnitClothOrder/KCCObody/KCCOitem/price) 0-1  (XPath KnitClothOrder/KCCObody/KCCOitem/phase/price) 0-1</p>
@priceQualifier	<p>type of price with reference to discount and taxes</p> <p>- base type: string, cod. table: NT20  <a href="http://www.ebiz.enea.it/moda-ml/repository/codelist/draft/gc_NT20.xml">http://www.ebiz.enea.it/moda-ml/repository/codelist/draft/gc_NT20.xml</a>  (XPath KnitClothOrder/KCCObody/KCCOitem/price/@priceQualifier) [Optional] [Default= NET]  (XPath KnitClothOrder/KCCObody/KCCOitem/phase/price/@priceQualifier) [Optional] [Default= NET]</p>
priority	<p>the priority of this row.</p> <p>- base type: string,  (XPath KnitClothOrder/KCCObody/KCCOitem/priority) 0-1</p>
@productLevel	<p>level of the product (end or intermediate) yielded by an operation in a work cycle</p> <p>- base type: string, cod. table: NT22  <a href="http://www.ebiz.enea.it/moda-ml/repository/codelist/draft/gc_NT22.xml">http://www.ebiz.enea.it/moda-ml/repository/codelist/draft/gc_NT22.xml</a>  (XPath KnitClothOrder/KCCObody/KCCOitem/@productLevel) [Optional] [Default= END]  - nota: <i>the qualifier "intermediate" must be used when the product is also a component in an other line of the same Commission Order</i></p>
productLine	<p>the product line name of a fashion product.</p> <p>- base type: string,  (XPath KnitClothOrder/KCCObody/KCCOitem/garComInfo/productLine) 0-1  (XPath KnitClothOrder/garComInfo/productLine) 0-1</p>
@progr	<p>progressive number in the sequence</p> <p>- base type: positiveInteger, min inclusive: 1,  (XPath KnitClothOrder/terms/transInfo/@progr) [Optional]  - nota: <i>Indicates the position of the leg in a sequence of transport legs.</i>  (XPath KnitClothOrder/KCCObody/KCCOitem/phase/packages/fillingCriterion/@progr) [Optional]</p>

	<p>(XPath KnitClothOrder/KCCObody/KCCOitem/phase/@progr) [Required]  (XPath KnitClothOrder/KCCObody/KCCOitem/packages/fillingCriterion/@progr) [Optional]</p>
project	<p>code used to assign the items ordered (fabric pieces, accessories, garments ...) to a specific project of the Client  - base type: string, max length: 40,  (XPath KnitClothOrder/garComInfo/project) 0-1  (XPath KnitClothOrder/KCCObody/KCCOitem/garComInfo/project) 0-1</p>
qty	<p>net quantity of the article or object correlated, qualified by the function of the document (ordering, delivering, ..) and by the context  - base type: decimal, min inclusive: 0, fraction digits: 2,  (XPath KnitClothOrder/KCCObody/KCCOitem/phase/qty) 0-2</p> <hr/> <p>AAAA-WARNING! - text not AVAILABLE n. 245 - In=en  - note: Total quantity produced by this phase.  (XPath KnitClothOrder/KCCObody/KCCOitem/phase/lotDetails/qty) 0-1  (XPath KnitClothOrder/KCCObody/KCCOitem/endUseGroup/qty) 0-1  (XPath KnitClothOrder/KCCObody/KCCOitem/apparelComponent/acsComponent/qty) 1-2</p> <hr/> <p>AAAA-WARNING! - text not AVAILABLE n. 245 - In=en  (XPath KnitClothOrder/KCCObody/KCCOitem/apparelComponent/fabricComponent/qty) 1-3  - note: quantity to be consumed in the transformation. This element can have more instances only if the units of measure are different  (XPath KnitClothOrder/KCCObody/KCCOitem/phase/lotDetails/csRange/sizeMatrix/sizeRow/qty) 0-1  (XPath KnitClothOrder/KCCObody/KCCOitem/apparelComponent/garmentPartComponent/qty) 1-2</p> <hr/> <p>AAAA-WARNING! - text not AVAILABLE n. 245 - In=en  (XPath KnitClothOrder/KCCObody/KCCOitem/garTecSheet/garConsumptionSet/garConsumption/qty) 1-1  - note: here is the provisional consumption  (XPath KnitClothOrder/KCCObody/KCCOitem/progress/qty) 1-2</p> <hr/> <p>AAAA-WARNING! - text not AVAILABLE n. 245 - In=en  (XPath KnitClothOrder/KCCObody/KCCOitem/apparelProd/csRange/sizeMatrix/sizeRow/qty) 0-1  (XPath KnitClothOrder/KCCObody/KCCOitem/apparelProd/qty) 1-2</p> <hr/> <p>AAAA-WARNING! - text not AVAILABLE n. 245 - In=en  (XPath KnitClothOrder/KCCObody/KCCOitem/phase/garConsumptionSet/garConsumption/qty) 1-1  - note: here is the provisional consumption  (XPath KnitClothOrder/KCCObody/KCCOitem/apparelComponent/yarnComponent/qty) 1-2</p> <hr/> <p>AAAA-WARNING! - text not AVAILABLE n. 245 - In=en  - note: quantity to be consumed in the manufacturing operation  (XPath KnitClothOrder/KCCObody/KCCOitem/endUseGroup/csRange/sizeMatrix/sizeRow/qty) 0-1</p>
qtyVariance	<p>difference between two quantities qualified by the context (e.g.: delivered vs . ordered; received vs. despatched etc..)  - base type: decimal, fraction digits: 2,  (XPath KnitClothOrder/KCCObody/KCCOitem/garTecSheet/garConsumptionSet/garConsumption/qtyVariance) 0-1  - note: here is the difference between provisional and effective consumption  (XPath KnitClothOrder/KCCObody/KCCOitem/phase/garConsumptionSet/garConsumption/qtyVariance) 0-1  - note: here is the difference between provisional and effective consumption</p>
qualityLevel	<p>the product quality level (first choice, second choice,...).  - base type: string,  (XPath KnitClothOrder/KCCObody/KCCOitem/endUseGroup/csRange/sizeMatrix/sizeRow/itemsList/qualityLevel) 0-1</p>



	<p>(XPath KnitClothOrder/KCCObody/KCCOitem/phase/lotDetails/csRange/sizeMatrix/sizeRow/itemsList/qualityLevel) 0-1</p> <p>(XPath KnitClothOrder/KCCObody/KCCOitem/progress/itemsList/qualityLevel) 0-1</p> <p>(XPath KnitClothOrder/KCCObody/KCCOitem/apparelComponent/fabricComponent/itemsList/qualityLevel) 0-1</p> <p>(XPath KnitClothOrder/KCCObody/KCCOitem/apparelProd/csRange/sizeMatrix/sizeRow/itemsList/qualityLevel) 0-1</p>
@reelMat	<p>type of material of which a package for yarn is made</p> <p>- base type: string, cod. table: T30</p> <p><a href="http://www.ebiz.enea.it/moda-ml/repository/codelist/draft/gc_T30.xml">http://www.ebiz.enea.it/moda-ml/repository/codelist/draft/gc_T30.xml</a></p> <p>(XPath KnitClothOrder/KCCObody/KCCOitem/packages/handlingChar/yarnPack/yarnReel/@reelMat) [Optional]</p> <p>(XPath KnitClothOrder/KCCObody/KCCOitem/phase/packages/handlingChar/yarnPack/yarnReel/@reelMat) [Optional]</p>
@reelType	<p>type of package used for a yarn product</p> <p>- base type: string, cod. table: T29</p> <p><a href="http://www.ebiz.enea.it/moda-ml/repository/codelist/draft/gc_T29.xml">http://www.ebiz.enea.it/moda-ml/repository/codelist/draft/gc_T29.xml</a></p> <p>(XPath KnitClothOrder/KCCObody/KCCOitem/packages/handlingChar/yarnPack/yarnReel/@reelType) [Required]</p> <p>(XPath KnitClothOrder/KCCObody/KCCOitem/phase/packages/handlingChar/yarnPack/yarnReel/@reelType) [Required]</p>
@role	<p>Third Party role qualifier</p> <p>- base type: string, cod. table: NT2</p> <p><a href="http://www.ebiz.enea.it/moda-ml/repository/codelist/draft/gc_NT2.xml">http://www.ebiz.enea.it/moda-ml/repository/codelist/draft/gc_NT2.xml</a></p> <p>(XPath KnitClothOrder/KCCObody/KCCOitem/phase/thirdParty/@role) [Required]</p> <p>(XPath KnitClothOrder/KCCOheader/thirdParty/@role) [Required]</p> <p>(XPath KnitClothOrder/KCCObody/KCCOitem/thirdParty/@role) [Required]</p>
season	<p>sale season; defined as: season (1 crt) + year (4 crt) - season: S/S=1 A/W=2 Spring=3 Summer=4 Autumn=5 Winter=6: for more than four seasons use alphabetic sequence: 1st season=A 2nd season=B etc.etc.</p> <p>- base type: string, max length: 15,</p> <p>(XPath KnitClothOrder/garComInfo/season) 0-1</p> <p>- note: <i>Preferably do not use this element here if season is declared in the header.</i></p> <p>(XPath KnitClothOrder/KCCObody/KCCOitem/apparelComponent/garmentPartComponent/refDoc/season) 0-1</p> <p>- note: <i>here indicates the season to which the referenced document belongs</i></p> <p>(XPath KnitClothOrder/KCCObody/KCCOitem/phase/refDoc/season) 0-1</p> <p>- note: <i>here indicates the season to which the referenced document belongs</i></p> <p>(XPath KnitClothOrder/KCCObody/KCCOitem/apparelComponent/yarnComponent/refDoc/season) 0-1</p> <p>- note: <i>here indicates the season to which the referenced document belongs</i></p> <p>(XPath KnitClothOrder/KCCOheader/refDoc/season) 0-1</p> <p>- note: <i>here indicates the season to which the referenced document belongs</i></p> <p>(XPath KnitClothOrder/KCCObody/KCCOitem/apparelComponent/fabricComponent/refDoc/season) 0-1</p> <p>- note: <i>here indicates the season to which the referenced document belongs</i></p> <p>(XPath KnitClothOrder/KCCObody/KCCOitem/appMnfrOperation/refDoc/season) 0-1</p> <p>- note: <i>here indicates the season to which the referenced document belongs</i></p> <p>(XPath KnitClothOrder/KCCOheader/season) 0-1</p> <p>(XPath KnitClothOrder/KCCObody/KCCOitem/apparelComponent/acsComponent/refDoc/season) 0-1</p> <p>- note: <i>here indicates the season to which the referenced document belongs</i></p> <p>(XPath KnitClothOrder/KCCObody/KCCOitem/garComInfo/season) 0-1</p> <p>- note: <i>Preferably do not use this element here if season is declared in the header.</i></p> <p>(XPath KnitClothOrder/KCCObody/KCCOitem/garTecSheet/refDoc/season) 0-1</p> <p>- note: <i>here indicates the season to which the referenced document belongs</i></p>

<p>@sender</p>	<p>qualifier that specifies the Party issuing of the document</p> <ul style="list-style-type: none"> <li>- base type: boolean,</li> <li>(XPath KnitClothOrder/KCCOheader/subContractor/@sender) [Optional]</li> <li>- nota: <i>This attribute is mandatory when the STYLESHEET must be used</i></li> <li>(XPath KnitClothOrder/KCCObody/KCCOitem/phase/thirdParty/@sender) [Optional]</li> <li>- nota: <i>This attribute is mandatory when the STYLESHEET must be used</i></li> <li>(XPath KnitClothOrder/KCCOheader/buyer/@sender) [Optional]</li> <li>- nota: <i>This attribute is mandatory when the STYLESHEET must be used</i></li> <li>(XPath KnitClothOrder/KCCObody/KCCOitem/thirdParty/@sender) [Optional]</li> <li>- nota: <i>This attribute is mandatory when the STYLESHEET must be used</i></li> <li>(XPath KnitClothOrder/KCCOheader/thirdParty/@sender) [Optional]</li> <li>- nota: <i>This attribute is mandatory when the STYLESHEET must be used</i></li> </ul>
<p>serialN</p>	<p>serial number used for the identification of a physical unit</p> <ul style="list-style-type: none"> <li>- base type: string, max length: 250,</li> <li>(XPath KnitClothOrder/KCCObody/KCCOitem/endUseGroup/csRange/sizeMatrix/sizeRow/itemsList/itemIdentification/serialN) 1-9</li> </ul> <hr/> <p><b>AAAA-WARNING! - text not AVAILABLE n. 245 - In=en</b></p> <ul style="list-style-type: none"> <li>- note: <i>multiple values of serialN are allowed for different representations of the serial identifier of the same product unit. Instances of serialN must differ at least for one value of numberingOrg and idQualifier.</i></li> </ul> <p>(XPath KnitClothOrder/KCCObody/KCCOitem/apparelComponent/fabricComponent/serialN) 0-unbounded</p> <ul style="list-style-type: none"> <li>- note: <i>it may be used to identify the pieces/chains that the Subcontractor must use for the commissioned work</i></li> </ul> <p>(XPath KnitClothOrder/KCCObody/KCCOitem/progress/itemsList/itemIdentification/serialN) 1-9</p> <hr/> <p><b>AAAA-WARNING! - text not AVAILABLE n. 245 - In=en</b></p> <ul style="list-style-type: none"> <li>- note: <i>multiple values of serialN are allowed for different representations of the serial identifier of the same product unit. Instances of serialN must differ at least for one value of numberingOrg and idQualifier.</i></li> </ul> <p>(XPath KnitClothOrder/KCCObody/KCCOitem/phase/lotDetails/csRange/sizeMatrix/sizeRow/itemsList/itemIdentification/serialN) 1-9</p> <hr/> <p><b>AAAA-WARNING! - text not AVAILABLE n. 245 - In=en</b></p> <ul style="list-style-type: none"> <li>- note: <i>multiple values of serialN are allowed for different representations of the serial identifier of the same product unit. Instances of serialN must differ at least for one value of numberingOrg and idQualifier.</i></li> </ul> <p>(XPath KnitClothOrder/KCCObody/KCCOitem/apparelComponent/fabricComponent/itemsList/itemIdentification/serialN) 1-9</p> <hr/> <p><b>AAAA-WARNING! - text not AVAILABLE n. 245 - In=en</b></p> <ul style="list-style-type: none"> <li>- note: <i>multiple values of serialN are allowed for different representations of the serial identifier of the same product unit. Instances of serialN must differ at least for one value of numberingOrg and idQualifier.</i></li> </ul> <p>(XPath KnitClothOrder/KCCObody/KCCOitem/apparelProd/csRange/sizeMatrix/sizeRow/itemsList/itemIdentification/serialN) 1-9</p> <hr/> <p><b>AAAA-WARNING! - text not AVAILABLE n. 245 - In=en</b></p> <ul style="list-style-type: none"> <li>- note: <i>multiple values of serialN are allowed for different representations of the serial identifier of the same product unit. Instances of serialN must differ at least for one value of numberingOrg and idQualifier.</i></li> </ul>
<p>size</p>	<p>size number of a fashion product (knitwear, clothing, ..)</p> <ul style="list-style-type: none"> <li>- base type: string, max length: 15,</li> <li>(XPath KnitClothOrder/KCCObody/KCCOitem/apparelComponent/garmentPartComponent/garmentPartCode/size) 0-1</li> <li>(XPath KnitClothOrder/KCCObody/KCCOitem/apparelProd/garmentCode/garmentCodeB/size) 0-1</li> <li>(XPath KnitClothOrder/KCCObody/KCCOitem/phase/lotDetails/csRange/sizeMatrix/sizeRow/size) 1-1</li> <li>(XPath KnitClothOrder/KCCObody/KCCOitem/phase/garConsumptionSet/garmentCode/garmentCodeB/size) 0-1</li> <li>(XPath KnitClothOrder/KCCObody/KCCOitem/phase/garConsumptionSet/garmentPartCode/size) 0-1</li> <li>(XPath KnitClothOrder/KCCObody/KCCOitem/apparelProd/garmentPartCode/size) 0-1</li> <li>(XPath KnitClothOrder/KCCObody/KCCOitem/garTecSheet/garConsumptionSet/garmentPartCode/size) 0-1</li> </ul>

	<p>(XPath KnitClothOrder/KCCObody/KCCOitem/garTecSheet/garMeaSet/garMea/size) 0-1</p> <p>(XPath KnitClothOrder/KCCObody/KCCOitem/garTecSheet/garmentCode/garmentCodeB/size) 0-1</p> <p>(XPath KnitClothOrder/KCCObody/KCCOitem/apparelProd/csRange/sizeMatrix/sizeRow/size) 1-1</p> <p>(XPath KnitClothOrder/KCCObody/KCCOitem/endUseGroup/csRange/sizeMatrix/sizeRow/size) 1-1</p> <p>(XPath KnitClothOrder/KCCObody/KCCOitem/garTecSheet/garConsumptionSet/garmentCode/garmentCodeB/size) 0-1</p>
sizeEnd	<p>first size of a range of sizes</p> <p>- base type: string, max length: 15,</p> <p>(XPath KnitClothOrder/KCCObody/KCCOitem/garTecSheet/garSizeSet/garSizeTier/sizeEnd) 0-1</p>
sizeStart	<p>first size of a range of sizes</p> <p>- base type: string, max length: 15,</p> <p>(XPath KnitClothOrder/KCCObody/KCCOitem/garTecSheet/garSizeSet/garSizeTier/sizeStart) 1-1</p>
@sizeSystemBase	<p>base of the size system</p> <p>- base type: string, cod. table: T423</p> <p><a href="http://www.ebiz.enea.it/moda-ml/repository/codelist/draft/gc_T423.xml">http://www.ebiz.enea.it/moda-ml/repository/codelist/draft/gc_T423.xml</a></p> <p>(XPath KnitClothOrder/KCCObody/KCCOitem/phase/lotDetails/csRange/@sizeSystemBase) [Optional]</p> <p>(XPath KnitClothOrder/KCCObody/KCCOitem/apparelProd/csRange/@sizeSystemBase) [Optional]</p> <p>(XPath KnitClothOrder/KCCObody/KCCOitem/endUseGroup/csRange/@sizeSystemBase) [Optional]</p>
@sizeSystemID	<p>the identifier of the size system.</p> <p>- base type: string,</p> <p>(XPath KnitClothOrder/KCCObody/KCCOitem/phase/lotDetails/csRange/@sizeSystemID) [Optional]</p> <p>(XPath KnitClothOrder/KCCObody/KCCOitem/apparelProd/csRange/@sizeSystemID) [Optional]</p> <p>(XPath KnitClothOrder/KCCObody/KCCOitem/endUseGroup/csRange/@sizeSystemID) [Optional]</p>
@sizeSystemNat	<p>nation or agency identifying the size system</p> <p>- base type: string, cod. table: T421</p> <p><a href="http://www.ebiz.enea.it/moda-ml/repository/codelist/draft/gc_T421.xml">http://www.ebiz.enea.it/moda-ml/repository/codelist/draft/gc_T421.xml</a></p> <p>(XPath KnitClothOrder/KCCObody/KCCOitem/endUseGroup/csRange/@sizeSystemNat) [Optional]</p> <p>(XPath KnitClothOrder/KCCObody/KCCOitem/apparelProd/csRange/@sizeSystemNat) [Optional]</p> <p>(XPath KnitClothOrder/KCCObody/KCCOitem/phase/lotDetails/csRange/@sizeSystemNat) [Optional]</p>
@sizeSystemSeg	<p>market segment identifying the size system</p> <p>- base type: string, cod. table: T422</p> <p><a href="http://www.ebiz.enea.it/moda-ml/repository/codelist/draft/gc_T422.xml">http://www.ebiz.enea.it/moda-ml/repository/codelist/draft/gc_T422.xml</a></p> <p>(XPath KnitClothOrder/KCCObody/KCCOitem/phase/lotDetails/csRange/@sizeSystemSeg) [Optional]</p> <p>(XPath KnitClothOrder/KCCObody/KCCOitem/apparelProd/csRange/@sizeSystemSeg) [Optional]</p> <p>(XPath KnitClothOrder/KCCObody/KCCOitem/endUseGroup/csRange/@sizeSystemSeg) [Optional]</p>
sortableIndicator	<p>It states if the item can be automatically sorted.</p> <p>- base type: boolean,</p> <p>(XPath KnitClothOrder/KCCObody/KCCOitem/phase/packages/handlingChar/sortableIndicator) 0-1</p> <p>(XPath KnitClothOrder/KCCObody/KCCOitem/packages/handlingChar/sortableIndicator) 0-1</p>

@source	party who has provided the data - base type: string, cod. table: NT12 <a href="http://www.ebiz.enea.it/moda-ml/repository/codelist/draft/gc_NT12.xml">http://www.ebiz.enea.it/moda-ml/repository/codelist/draft/gc_NT12.xml</a> (XPath KnitClothOrder/KCCObody/KCCOitem/garTecSheet/garMeaSet/garMea/specValue/@source) [Optional]
specDate	date by which the referenced blanket order must receive full product specific ations (e.g.: colour), according to one of the patterns YYYY-MM-DD, YYYY-MM-DD:HH-MM or YYYY-WW. - base type: string, (XPath KnitClothOrder/KCCObody/KCCOitem/garComInfo/specDate) 0-1 (XPath KnitClothOrder/garComInfo/specDate) 0-1
specValue	value requested for a property or a parameter that is measured - base type: decimal, (XPath KnitClothOrder/KCCObody/KCCOitem/garTecSheet/garMeaSet/garMea/specValue) 1-1
stackabilityLevel	This value indicates the level at which the item can be stacked. - base type: integer, (XPath KnitClothOrder/KCCObody/KCCOitem/packages/handlingChar/stackabilityLevel) 0-1 (XPath KnitClothOrder/KCCObody/KCCOitem/phase/packages/handlingChar/stackabilityLevel) 0-1
street	street and building number identifying a location - base type: string, max length: 80, (XPath KnitClothOrder/KCCOheader/subContractor/street) 0-1 (XPath KnitClothOrder/KCCOheader/thirdParty/street) 0-1 (XPath KnitClothOrder/KCCObody/KCCOitem/phase/thirdParty/street) 0-1 (XPath KnitClothOrder/KCCObody/KCCOitem/thirdParty/street) 0-1 (XPath KnitClothOrder/KCCOheader/buyer/street) 0-1
subCountry	short name or code of the sub-country entity - base type: string, max length: 9, (XPath KnitClothOrder/KCCOheader/buyer/subCountry) 0-1 (XPath KnitClothOrder/KCCObody/KCCOitem/phase/thirdParty/subCountry) 0-1 (XPath KnitClothOrder/KCCOheader/thirdParty/subCountry) 0-1 (XPath KnitClothOrder/KCCObody/KCCOitem/thirdParty/subCountry) 0-1 (XPath KnitClothOrder/KCCOheader/subContractor/subCountry) 0-1
subDept	name or code of a contact department within a Party - base type: string, max length: 40, (XPath KnitClothOrder/KCCOheader/thirdParty/subDept) 0-1 (XPath KnitClothOrder/KCCOheader/subContractor/subDept) 0-1 (XPath KnitClothOrder/KCCOheader/buyer/subDept) 0-1 (XPath KnitClothOrder/KCCObody/KCCOitem/phase/thirdParty/subDept) 0-1 (XPath KnitClothOrder/KCCObody/KCCOitem/thirdParty/subDept) 0-1
@subject	qualifier of the product treated in the note - base type: string, cod. table: NT40 <a href="http://www.ebiz.enea.it/moda-ml/repository/codelist/draft/gc_NT40.xml">http://www.ebiz.enea.it/moda-ml/repository/codelist/draft/gc_NT40.xml</a> (XPath KnitClothOrder/KCCObody/KCCOitem/garTecSheet/image/@subject) [Optional] (XPath KnitClothOrder/KCCObody/KCCOitem/garTecSheet/mnfrNote/@subject) [Optional]
taxCategory	duty or tax or fee category - base type: string, cod. table: T62 <a href="http://www.ebiz.enea.it/moda-ml/repository/codelist/draft/gc_T62.xml">http://www.ebiz.enea.it/moda-ml/repository/codelist/draft/gc_T62.xml</a> (XPath KnitClothOrder/terms/allowanceCharge/dtScheme/taxCategory) 0-1 (XPath KnitClothOrder/KCCObody/KCCOitem/dtScheme/taxCategory) 0-1
taxRate	duty or tax or fee percent rate - base type: string, (XPath KnitClothOrder/terms/allowanceCharge/dtScheme/taxRate) 0-1 (XPath KnitClothOrder/KCCObody/KCCOitem/dtScheme/taxRate) 0-1

@taxType	duty or tax or fee type - base type: string, cod. table: T61 <a href="http://www.ebiz.enea.it/moda-ml/repository/codelist/draft/gc_T61.xml">http://www.ebiz.enea.it/moda-ml/repository/codelist/draft/gc_T61.xml</a> (XPath KnitClothOrder/terms/allowanceCharge/dtScheme/@taxType) [Required] (XPath KnitClothOrder/KCCObody/KCCOitem/dtScheme/@taxType) [Required]
@TID	serial number wired into the RFID chip - base type: string, (XPath KnitClothOrder/KCCObody/KCCOitem/phase/packages/EPClist/EPC/@TID) [Optional] (XPath KnitClothOrder/KCCObody/KCCOitem/packages/EPClist/EPC/@TID) [Optional]
transCondition	special condition of transport or special service requested to the Forwarder - base type: string, cod. table: T38 <a href="http://www.ebiz.enea.it/moda-ml/repository/codelist/draft/gc_T38.xml">http://www.ebiz.enea.it/moda-ml/repository/codelist/draft/gc_T38.xml</a> (XPath KnitClothOrder/terms/transInfo/transCondition) 0-3
transConditionText	free text description of the special condition of transport or special service requested to the Forwarder - base type: string, max length: 250, (XPath KnitClothOrder/terms/transInfo/transConditionText) 0-1
transMeans	means of transport, in general or referred to a specific leg - base type: string, cod. table: T40 <a href="http://www.ebiz.enea.it/moda-ml/repository/codelist/draft/gc_T40.xml">http://www.ebiz.enea.it/moda-ml/repository/codelist/draft/gc_T40.xml</a> (XPath KnitClothOrder/terms/transInfo/transMeans) 0-1
transMode	way of transport, in general or referred to the specified leg - base type: string, cod. table: T8 <a href="http://www.ebiz.enea.it/moda-ml/repository/codelist/draft/gc_T8.xml">http://www.ebiz.enea.it/moda-ml/repository/codelist/draft/gc_T8.xml</a> (XPath KnitClothOrder/terms/transInfo/transMode) 1-1
@transReason	reason for the transport - base type: string, cod. table: NT11 <a href="http://www.ebiz.enea.it/moda-ml/repository/codelist/draft/gc_NT11.xml">http://www.ebiz.enea.it/moda-ml/repository/codelist/draft/gc_NT11.xml</a> (XPath KnitClothOrder/terms/transInfo/@transReason) [Optional]
@uid	unique element identifier within the xml document - base type: string, (XPath KnitClothOrder/KCCObody/KCCOitem/apparelComponent/acsComponent/refDoc/attachment/@uid) [Optional] (XPath KnitClothOrder/KCCObody/KCCOitem/apparelComponent/fabricComponent/refDoc/attachment/@uid) [Optional] (XPath KnitClothOrder/KCCObody/KCCOitem/phase/refDoc/attachment/@uid) [Optional] (XPath KnitClothOrder/KCCObody/KCCOitem/appMnfrOperation/refDoc/attachment/@uid) [Optional] (XPath KnitClothOrder/KCCObody/KCCOitem/apparelComponent/yarnComponent/refDoc/attachment/@uid) [Optional] (XPath KnitClothOrder/KCCObody/KCCOitem/apparelComponent/garmentPartComponent/refDoc/attachment/@uid) [Optional] (XPath KnitClothOrder/KCCOheader/refDoc/attachment/@uid) [Optional] (XPath KnitClothOrder/KCCObody/KCCOitem/garTecSheet/refDoc/attachment/@uid) [Optional]
@um	specification of the unit of measure - base type: string, cod. table: NT7 <a href="http://www.ebiz.enea.it/moda-ml/repository/codelist/draft/gc_NT7.xml">http://www.ebiz.enea.it/moda-ml/repository/codelist/draft/gc_NT7.xml</a> (XPath KnitClothOrder/KCCObody/KCCOitem/packages/handlingChar/yarnPack/yarnReel/yarnReelH/@um) [Required] (XPath KnitClothOrder/KCCObody/KCCOitem/packages/handlingChar/yarnPack/yarnReel/yarnReelID/@um) [Required] (XPath KnitClothOrder/KCCObody/KCCOitem/packages/packageDim/width/@um) [Required] (XPath KnitClothOrder/KCCObody/KCCOitem/packages/packageDim/height/@um) [Required]

(XPath KnitClothOrder/KCCObody/KCCOitem/packages/packageDim/length/@um) [Required]

(XPath KnitClothOrder/KCCObody/KCCOitem/phase/packages/handlingChar/netWeight/@um) [Required]

(XPath KnitClothOrder/KCCObody/KCCOitem/phase/packages/minItemsPerPackage/@um) [Required]

(XPath KnitClothOrder/KCCObody/KCCOitem/apparelProd/qty/@um) [Required]

(XPath KnitClothOrder/KCCObody/KCCOitem/packages/itemsPerPackage/@um) [Required]

(XPath KnitClothOrder/terms/allowanceCharge/@um) [Optional]

(XPath KnitClothOrder/KCCObody/KCCOitem/packages/handlingChar/netWeight/@um) [Required]

(XPath KnitClothOrder/KCCObody/KCCOitem/packages/handlingChar/volume/@um) [Required]

(XPath KnitClothOrder/KCCObody/KCCOitem/packages/handlingChar/grossWeight/@um) [Required]

(XPath KnitClothOrder/KCCObody/KCCOitem/phase/packages/itemsPerPackage/@um) [Required]

(XPath KnitClothOrder/terms/transInfo/netWeight/@um) [Required]

(XPath KnitClothOrder/terms/transInfo/grossWeight/@um) [Required]

(XPath KnitClothOrder/KCCObody/KCCOitem/packages/handlingChar/yarnPack/yarnReel/yarnReelQty/@um) [Required]

(XPath KnitClothOrder/KCCObody/KCCOitem/price/@um) [Optional]

- nota: *Unit of measure of the product to which the price is referred (price per meter)*

(XPath KnitClothOrder/KCCObody/KCCOitem/apparelProd/csRange/sizeMatrix/sizeRow/qty/@um) [Required]

(XPath KnitClothOrder/KCCObody/KCCOitem/packages/minItemsPerPackage/@um) [Required]

(XPath KnitClothOrder/KCCObody/KCCOitem/phase/packages/handlingChar/grossWeight/@um) [Required]

(XPath KnitClothOrder/KCCObody/KCCOitem/phase/garConsumptionSet/garConsumption/qtyVariance/@um) [Optional]

(XPath KnitClothOrder/KCCObody/KCCOitem/apparelComponent/yarnComponent/pcQty/@um) [Optional]

- nota: *to be used when it has to be soecified if the declared percentage is by weight, volume, etc...*

(XPath KnitClothOrder/KCCObody/KCCOitem/phase/lotDetails/qty/@um) [Required]

(XPath KnitClothOrder/KCCObody/KCCOitem/phase/garConsumptionSet/garConsumption/qty/@um) [Required]

(XPath KnitClothOrder/KCCObody/KCCOitem/progress/qty/@um) [Required]

(XPath KnitClothOrder/KCCObody/KCCOitem/phase/packages/packageDim/width/@um) [Required]

(XPath KnitClothOrder/KCCObody/KCCOitem/phase/packages/packageDim/length/@um) [Required]

(XPath KnitClothOrder/KCCObody/KCCOitem/endUseGroup/csRange/sizeMatrix/sizeRow/qty/@um) [Required]

(XPath KnitClothOrder/KCCObody/KCCOitem/apparelComponent/garmentPartComponent/qty/@um) [Required]

(XPath KnitClothOrder/KCCObody/KCCOitem/phase/packages/handlingChar/yarnPack/yarnReel/yarnReelQty/@um) [Required]

(XPath KnitClothOrder/KCCObody/KCCOitem/apparelComponent/acsComponent/qty/@um) [Required]

(XPath KnitClothOrder/KCCObody/KCCOitem/phase/price/@um) [Optional]

- nota: *Unit of measure of the product to which the price is referred (price per meter)*

(XPath KnitClothOrder/KCCObody/KCCOitem/phase/qty/@um) [Required]

(XPath KnitClothOrder/KCCObody/KCCOitem/apparelComponent/yarnComponent/qty/@um) [Required]

(XPath KnitClothOrder/KCCObody/KCCOitem/phase/packages/handlingChar/yarnPack/yarnReel/yarnReelH/@um) [Required]

(XPath KnitClothOrder/KCCObody/KCCOitem/apparelComponent/fabricComponent/qty/@um) [Required]

	<p>(XPath KnitClothOrder/KCCObody/KCCOitem/phase/packages/packageDim/height/@um) [Required]</p> <p>(XPath KnitClothOrder/KCCObody/KCCOitem/garTecSheet/garMeaSet/garMea/specValue/@um) [Optional]</p> <p>(XPath KnitClothOrder/KCCObody/KCCOitem/phase/packages/handlingChar/volume/@um) [Required]</p> <p>(XPath KnitClothOrder/KCCObody/KCCOitem/endUseGroup/qty/@um) [Required]</p> <p>(XPath KnitClothOrder/KCCObody/KCCOitem/garTecSheet/grossWeight/@um) [Required]</p> <p>(XPath KnitClothOrder/KCCObody/KCCOitem/garTecSheet/garConsumptionSet/garConsumption/qty/@um) [Required]</p> <p>(XPath KnitClothOrder/KCCObody/KCCOitem/phase/lotDetails/csRange/sizeMatrix/sizeRow/qty/@um) [Required]</p> <p>(XPath KnitClothOrder/KCCObody/KCCOitem/garTecSheet/netWeight/@um) [Required]</p> <p>(XPath KnitClothOrder/KCCObody/KCCOitem/phase/packages/handlingChar/yarnPack/yarnReel/yarnReelID/@um) [Required]</p> <p>(XPath KnitClothOrder/KCCObody/KCCOitem/garTecSheet/garConsumptionSet/garConsumption/qtyVariance/@um) [Optional]</p>
uri	<p>Uniform Resource Identifier (URI) that identifies the external object as an Internet resource</p> <p>- base type: normalizedString,</p> <p>(XPath KnitClothOrder/KCCObody/KCCOitem/apparelComponent/yarnComponent/refDoc/attachment/externalReference/uri) 1-1</p> <p>(XPath KnitClothOrder/KCCObody/KCCOitem/appMnfrOperation/refDoc/attachment/externalReference/uri) 1-1</p> <p>(XPath KnitClothOrder/KCCObody/KCCOitem/phase/refDoc/attachment/externalReference/uri) 1-1</p> <p>(XPath KnitClothOrder/KCCObody/KCCOitem/apparelComponent/fabricComponent/refDoc/attachment/externalReference/uri) 1-1</p> <p>(XPath KnitClothOrder/KCCOheader/refDoc/attachment/externalReference/uri) 1-1</p> <p>(XPath KnitClothOrder/KCCObody/KCCOitem/apparelComponent/acsComponent/refDoc/attachment/externalReference/uri) 1-1</p> <p>(XPath KnitClothOrder/KCCObody/KCCOitem/garTecSheet/refDoc/attachment/externalReference/uri) 1-1</p> <p>(XPath KnitClothOrder/KCCObody/KCCOitem/apparelComponent/garmentPartComponent/refDoc/attachment/externalReference/uri) 1-1</p>
@useProfile	<p>use profile to which the present document is compliant if it was agreed by the parties. It is suggested a URI with reference to the firms or the URL of the profile.</p> <p>- base type: string,</p> <p>(XPath KnitClothOrder/@useProfile) [Optional]</p>
validityEnd	<p>date by which the validity ends, according to one of the patterns YYYY-MM-DD, YYYY-MM-DD:HH-MM or YYYY-WW.</p> <p>- base type: string,</p> <p>(XPath KnitClothOrder/KCCOheader/validityEnd) 0-1</p>
validityStart	<p>date by which the validity starts, according to one of the patterns YYYY-MM-DD, YYYY-MM-DD:HH-MM or YYYY-WW.</p> <p>- base type: string,</p> <p>(XPath KnitClothOrder/KCCOheader/validityStart) 0-1</p>
variantCode	<p>Code of variant used for fashion product.</p> <p>- base type: string,</p> <p>(XPath KnitClothOrder/KCCObody/KCCOitem/endUseGroup/csRange/garmentVariant/variantCode) 1-1</p> <p>(XPath KnitClothOrder/KCCObody/KCCOitem/apparelProd/csRange/garmentVariant/variantCode) 1-1</p> <p>(XPath KnitClothOrder/KCCObody/KCCOitem/garTecSheet/garConsumptionSet/garmentCode/garmentCodeB/garmentVariant/variantCode) 1-1</p> <p>(XPath KnitClothOrder/KCCObody/KCCOitem/phase/lotDetails/csRange/garmentVariant/variantCode) 1-1</p>

	<p>(XPath KnitClothOrder/KCCObody/KCCOitem/phase/garConsumptionSet/garmentCode/garmentCodeB/garmentVariant/variantCode) 1-1</p> <p>(XPath KnitClothOrder/KCCObody/KCCOitem/apparelProd/garmentCode/garmentCodeB/garmentVariant/variantCode) 1-1</p> <p>(XPath KnitClothOrder/KCCObody/KCCOitem/garTecSheet/garmentCode/garmentCodeB/garmentVariant/variantCode) 1-1</p>
variantType	<p>Type of variant used for fashion product (examples: 'treatment', 'washing type', 'size class',...)</p> <p>- base type: string,</p> <p>(XPath KnitClothOrder/KCCObody/KCCOitem/endUseGroup/csRange/garmentVariant/variantType) 1-1</p> <p>(XPath KnitClothOrder/KCCObody/KCCOitem/phase/lotDetails/csRange/garmentVariant/variantType) 1-1</p> <p>(XPath KnitClothOrder/KCCObody/KCCOitem/apparelProd/csRange/garmentVariant/variantType) 1-1</p> <p>(XPath KnitClothOrder/KCCObody/KCCOitem/garTecSheet/garConsumptionSet/garmentCode/garmentCodeB/garmentVariant/variantType) 1-1</p> <p>(XPath KnitClothOrder/KCCObody/KCCOitem/garTecSheet/garmentCode/garmentCodeB/garmentVariant/variantType) 1-1</p> <p>(XPath KnitClothOrder/KCCObody/KCCOitem/phase/garConsumptionSet/garmentCode/garmentCodeB/garmentVariant/variantType) 1-1</p> <p>(XPath KnitClothOrder/KCCObody/KCCOitem/apparelProd/garmentCode/garmentCodeB/garmentVariant/variantType) 1-1</p>
@varReason	<p>reason for the difference between the two quantities specified by the context</p> <p>- base type: string, cod. table: T46</p> <p><a href="http://www.ebiz.enea.it/moda-ml/repository/codelist/draft/gc_T46.xml">http://www.ebiz.enea.it/moda-ml/repository/codelist/draft/gc_T46.xml</a></p> <p>(XPath KnitClothOrder/KCCObody/KCCOitem/garTecSheet/garConsumptionSet/garConsumption/qtyVariance/@varReason) [Optional]</p> <p>(XPath KnitClothOrder/KCCObody/KCCOitem/phase/garConsumptionSet/garConsumption/qtyVariance/@varReason) [Optional]</p>
@VAT	<p>VAT rate or code (DEPRECATED, use dtScheme element)</p> <p>- base type: string, cod. table: NT16</p> <p><a href="http://www.ebiz.enea.it/moda-ml/repository/codelist/draft/gc_NT16.xml">http://www.ebiz.enea.it/moda-ml/repository/codelist/draft/gc_NT16.xml</a></p> <p>(XPath KnitClothOrder/KCCObody/KCCOitem/phase/thirdParty/@VAT) [Optional]</p> <p>(XPath KnitClothOrder/KCCOheader/thirdParty/@VAT) [Optional]</p> <p>(XPath KnitClothOrder/terms/allowanceCharge/@VAT) [Optional]</p> <p>(XPath KnitClothOrder/KCCObody/KCCOitem/lineN/@VAT) [Optional]</p> <p>- nota: <i>Deprecated, prefer dtScheme when available.</i></p> <p>(XPath KnitClothOrder/KCCObody/KCCOitem/thirdParty/@VAT) [Optional]</p>
@version	<p>Dictionary version from which the instance has been created</p> <p>- base type: string, cod. table: NT100</p> <p><a href="http://www.ebiz.enea.it/moda-ml/repository/codelist/draft/gc_NT100.xml">http://www.ebiz.enea.it/moda-ml/repository/codelist/draft/gc_NT100.xml</a></p> <p>(XPath KnitClothOrder/@version) [Optional] [Default= draft]</p>
volume	<p>effective volume of a specified object</p> <p>- base type: decimal, min inclusive: 0, fraction digits: 2,</p> <p>(XPath KnitClothOrder/KCCObody/KCCOitem/phase/packages/handlingChar/volume) 0-1</p> <p>(XPath KnitClothOrder/KCCObody/KCCOitem/packages/handlingChar/volume) 0-1</p>
warpLetter	<p>letter that indicates a specific yarn in the warping formula (diagram)</p> <p>- base type: string, length: 1,</p> <p>(XPath KnitClothOrder/KCCObody/KCCOitem/apparelComponent/yarnComponent/warpLetter) 0-1</p> <p>- note: <i>to be used only in the Warping order</i></p>
weftLetter	<p>letter that indicates a specific yarn in the wefting formula (diagram)</p> <p>- base type: string, length: 1,</p>



	<p>(XPath KnitClothOrder/KCCObody/KCCOitem/apparelComponent/yarnComponent/weftLetter) 0-1</p> <p>- note: <i>to be used only in the Weaving order</i></p>
width	<p>effective width of a specified object</p> <p>- base type: decimal, min inclusive: 0, fraction digits: 2,</p> <p>(XPath KnitClothOrder/KCCObody/KCCOitem/phase/packages/packageDim/width) 0-1</p> <p>(XPath KnitClothOrder/KCCObody/KCCOitem/packages/packageDim/width) 0-1</p>
yarnConeAngle	<p>tapering angle of the cone on which a yarn is reeled</p> <p>- base type: positiveInteger,</p> <p>(XPath KnitClothOrder/KCCObody/KCCOitem/phase/packages/handlingChar/yarnPack/yarnReel/yarnConeAngle) 0-1</p> <p>(XPath KnitClothOrder/KCCObody/KCCOitem/packages/handlingChar/yarnPack/yarnReel/yarnConeAngle) 0-1</p>
yarnOutWrap	<p>code specifying the type of outer wrapping or packing of a yarn</p> <p>- base type: string, cod. table: T33</p> <p><a href="http://www.ebiz.enea.it/moda-ml/repository/codelist/draft/gc_T33.xml">http://www.ebiz.enea.it/moda-ml/repository/codelist/draft/gc_T33.xml</a></p> <p>(XPath KnitClothOrder/KCCObody/KCCOitem/phase/packages/handlingChar/yarnPack/yarnOutWrap) 0-1</p> <p>(XPath KnitClothOrder/KCCObody/KCCOitem/packages/handlingChar/yarnPack/yarnOutWrap) 0-1</p>
yarnOutWrapText	<p>free text specifying the type of outer wrapping or packing of a yarn</p> <p>- base type: string, max length: 250,</p> <p>(XPath KnitClothOrder/KCCObody/KCCOitem/packages/handlingChar/yarnPack/yarnOutWrapText) 0-1</p> <p>(XPath KnitClothOrder/KCCObody/KCCOitem/phase/packages/handlingChar/yarnPack/yarnOutWrapText) 0-1</p>
yarnReelD	<p>diameter of the bobbin used for a yarn product</p> <p>- base type: decimal, min inclusive: 0, fraction digits: 2,</p> <p>(XPath KnitClothOrder/KCCObody/KCCOitem/phase/packages/handlingChar/yarnPack/yarnReel/yarnReelD) 0-1</p> <p>(XPath KnitClothOrder/KCCObody/KCCOitem/packages/handlingChar/yarnPack/yarnReel/yarnReelD) 0-1</p>
yarnReelH	<p>height of the bobbin used a yarn product</p> <p>- base type: decimal, min inclusive: 0, fraction digits: 2,</p> <p>(XPath KnitClothOrder/KCCObody/KCCOitem/packages/handlingChar/yarnPack/yarnReel/yarnReelH) 0-1</p> <p>(XPath KnitClothOrder/KCCObody/KCCOitem/phase/packages/handlingChar/yarnPack/yarnReel/yarnReelH) 0-1</p>
yarnReelQty	<p>quantity of yarn (by weight or length) wound upon a bobbin</p> <p>- base type: decimal, min inclusive: 0, fraction digits: 2,</p> <p>(XPath KnitClothOrder/KCCObody/KCCOitem/phase/packages/handlingChar/yarnPack/yarnReel/yarnReelQty) 0-2</p> <p>(XPath KnitClothOrder/KCCObody/KCCOitem/packages/handlingChar/yarnPack/yarnReel/yarnReelQty) 0-2</p>
yarnReelWrap	<p>type of wrapping in which a package of yarn is wrapped</p> <p>- base type: string, cod. table: T32</p> <p><a href="http://www.ebiz.enea.it/moda-ml/repository/codelist/draft/gc_T32.xml">http://www.ebiz.enea.it/moda-ml/repository/codelist/draft/gc_T32.xml</a></p> <p>(XPath KnitClothOrder/KCCObody/KCCOitem/phase/packages/handlingChar/yarnPack/yarnInWrap/yarnReelWrap) 1-1</p> <p>(XPath KnitClothOrder/KCCObody/KCCOitem/packages/handlingChar/yarnPack/yarnInWrap/yarnReelWrap) 1-1</p>

## 2.3 Suggested best practices

**KnitClothOrder/KCCObody/KCCOitem/phase/qty** (net quantity of the article or object correlated, qualified by the function of the document (ordering, delivering, ..) and by the context)

this element can have two instances only if the units of measure are different

**KnitClothOrder/KCCObody/KCCOitem/apparelComponent/**

**acsComponent/qty** (net quantity of the article or object correlated, qualified by the function of the document (ordering, delivering, ..) and by the context)

this element can have two instances only if the units of measure are different

**KnitClothOrder/KCCObody/KCCOitem/apparelComponent/**

**garmentPartComponent/qty** (net quantity of the article or object correlated, qualified by the function of the document (ordering, delivering, ..) and by the context)

this element can have two instances only if the units of measure are different

**KnitClothOrder/KCCObody/KCCOitem/progress/qty** (net quantity of the article or object correlated, qualified by the function of the document (ordering, delivering, ..) and by the context)

this element can have two instances only if the units of measure are different

**KnitClothOrder/KCCObody/KCCOitem/apparelProd/qty** (net quantity of the article or object correlated, qualified by the function of the document (ordering, delivering, ..) and by the context)

this element can have two instances only if the units of measure are different

**KnitClothOrder/KCCObody/KCCOitem/apparelComponent/**

**yarnComponent/qty** (net quantity of the article or object correlated, qualified by the function of the document (ordering, delivering, ..) and by the context)

this element can have two instances only if the units of measure are different

**KnitClothOrder/KCCObody/KCCOitem/endUseGroup/**

**csRange/sizeMatrix/sizeRow/itemsList/itemIdentification/serialN** (serial number used for the identification of a physical unit)

in the case of garment with RFID for anti-counterfeiting, RFID EPCGlobal for logistics and NFC for the customer experience there should be three serial elements with pairs of attributes numberingOrg/idQualifier: "CL"/"RFID", "GS1"/"RFID", "CL"/"NFC".

**KnitClothOrder/KCCObody/KCCOitem/progress/**

**itemsList/itemIdentification/serialN** (serial number used for the identification of a physical unit)

in the case of garment with RFID for anti-counterfeiting, RFID EPCGlobal for logistics and NFC for the customer experience there should be three serial elements with pairs of attributes numberingOrg/idQualifier: "CL"/"RFID", "GS1"/"RFID", "CL"/"NFC".

**KnitClothOrder/KCCObody/KCCOitem/phase/lotDetails/**

**csRange/sizeMatrix/sizeRow/itemsList/itemIdentification/serialN** (serial number used for the identification of a physical unit)

in the case of garment with RFID for anti-counterfeiting, RFID EPCGlobal for logistics and NFC for the customer experience there should be three serial elements with pairs of attributes numberingOrg/idQualifier: "CL"/"RFID", "GS1"/"RFID", "CL"/"NFC".

**KnitClothOrder/KCCObody/KCCOitem/apparelComponent/**

**fabricComponent/itemsList/itemIdentification/serialN** (serial number used for the identification of a physical unit)

in the case of garment with RFID for anti-counterfeiting, RFID EPCGlobal for logistics and NFC for the customer experience there should be three serial elements with pairs of attributes numberingOrg/idQualifier: "CL"/"RFID", "GS1"/"RFID", "CL"/"NFC".

**KnitClothOrder/KCCObody/KCCOitem/apparelProd/**

**csRange/sizeMatrix/sizeRow/itemsList/itemIdentification/serialN** (serial number used for the identification of a physical unit)

in the case of garment with RFID for anti-counterfeiting, RFID EPCGlobal for logistics and NFC for the customer experience there should be three serial elements with pairs of attributes numberingOrg/idQualifier: "CL"/"RFID", "GS1"/"RFID", "CL"/"NFC".

## 2.4 Enumeration tables

List of enumeration tables used in the XML document. You can find the corresponding codes at:  
<http://www.ebiz-tcf.eu/moda-ml/imple/moda-ml-draft.asp?lingua=en&pag=6>

NT1 - Order type  
NT100 - eBIZ TCFUpstream version  
NT11 - transport causal  
NT12 - data source  
NT16 - VAT rate or code  
NT18 - message function  
NT2 - third party qualifier  
NT20 - price qualifier  
NT22 - product type of an operation  
NT29 - format of a date  
NT3 - data format  
NT37 - committed quantity qualifier  
NT39 - consumption type  
NT4 - end use  
NT40 - manufacturing note qualifiers  
NT41 - garment attributes  
NT43 - operational code qualifier  
NT51 - Filling Criterion for Package homogeneity  
NT6 - coding system owner/issuer  
NT7 - unit of measure  
T1 - terms of payment  
T10 - ISO3166 - Country  
T11 - transport package type  
T19 - fibre type  
T2 - Modes of payment  
T205 - type of job in knitting/clothing  
T21 - type of document  
T265 - type of job technology in knitting/clothing  
T275 - type of machine for knitting/clothing  
T29 - type of yarn package  
T3 - terms of delivery  
T30 - support of yarn package - material  
T32 - yarn reel wrapping type  
T33 - yarn outer packing  
T38 - transport conditions  
T4 - fabric piece inner packing (wrapping) 1  
T40 - type of transport means  
T41 - type of Allowance or Charge  
T421 - size system: nationality  
T422 - size system: market segment  
T423 - size system: base  
T44 - additional code type  
T46 - quantity variance reason  
T48 - garment part type  
T5 - fabric piece inner packing (wrapping) 2  
T6 - fabric piece outer packing  
T61 - duty or tax or fee type  
T62 - duty or tax or fee category  
T7 - manufacturing status  
T8 - Modes of Transport  
T9 - ISO4217 - Currency

## ACKNOWLEDGEMENT



This action is part of the eBIZ-4.0 project, which has received funding from the European Union's COSME Programme (2014 - 2020).

## DISCLAIMER

The content of this document represents the views of the authors only and is their sole responsibility; it cannot be considered to reflect the views of the European Commission and/or the Executive Agency for Small and Medium-sized Enterprises (EASME) or any other body of the European Union.

The European Commission and the Agency do not accept any responsibility for use that may be made of the information it contains.

## Annex A

Representative images of the principal complex elements' structure.

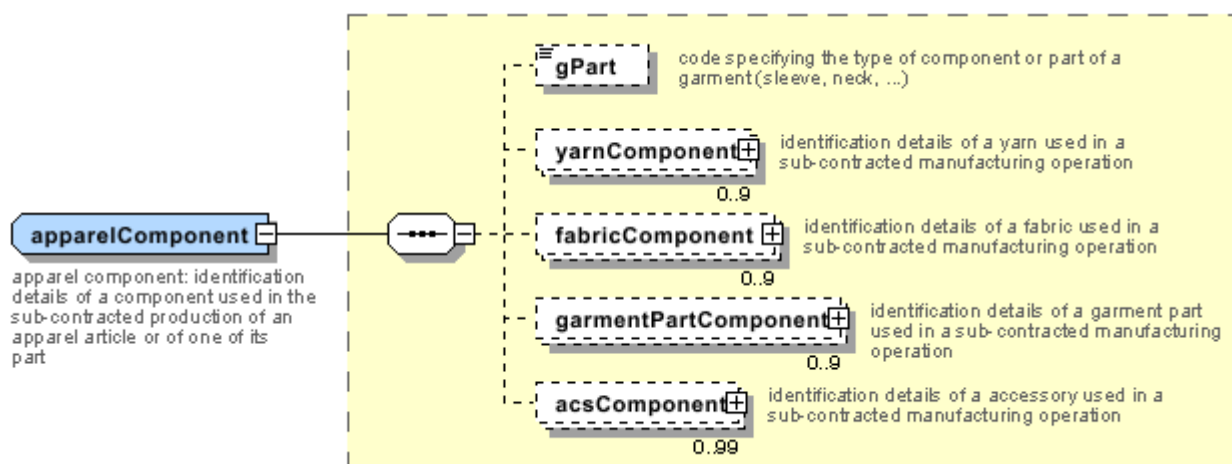
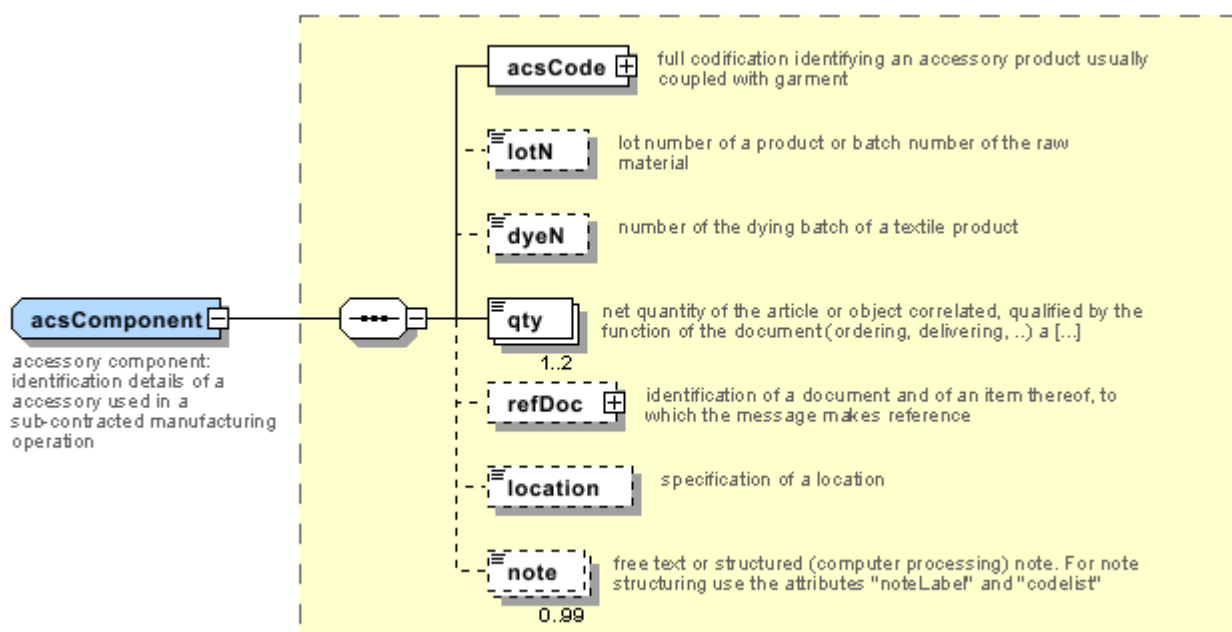

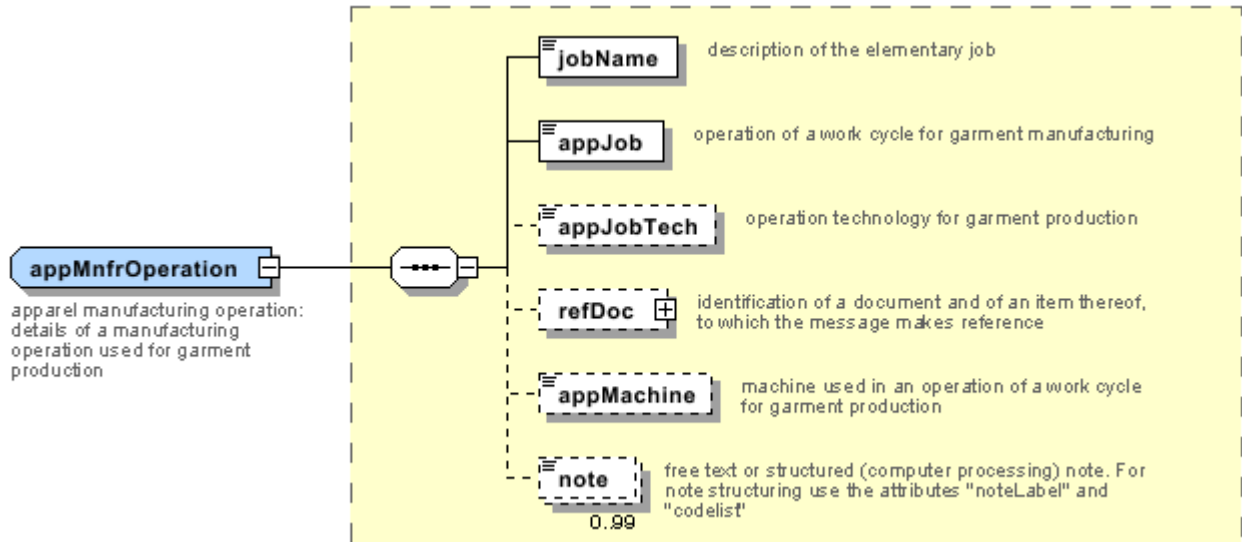
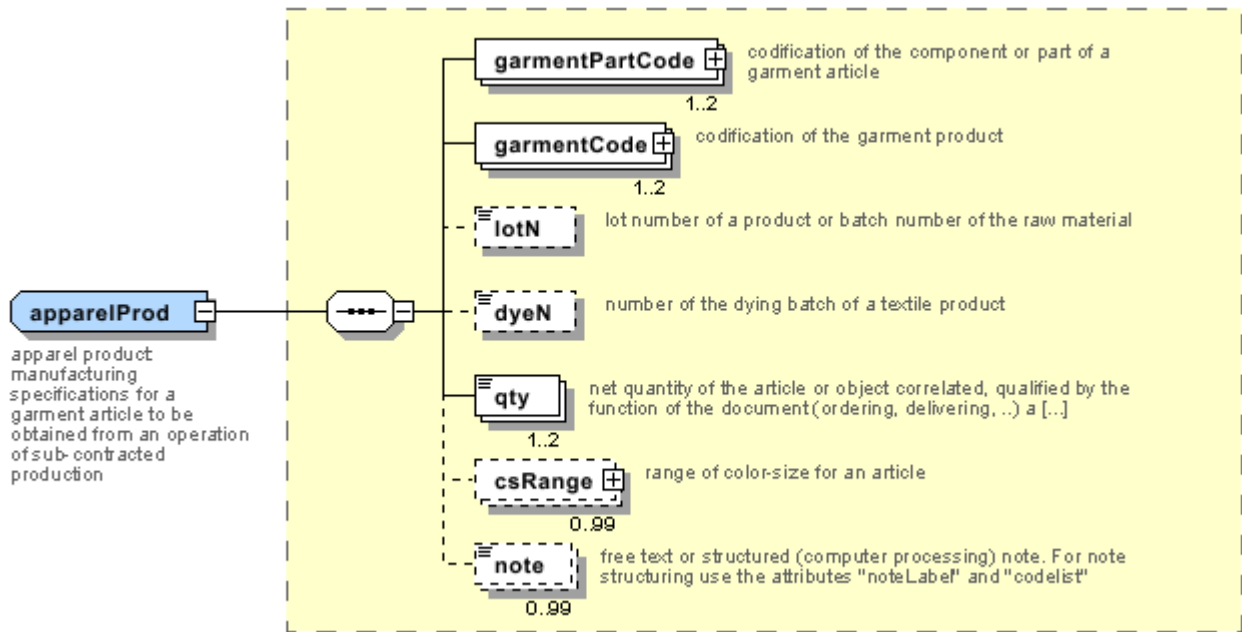

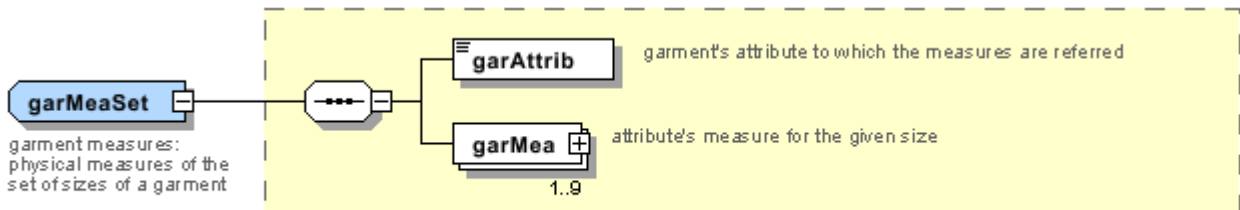
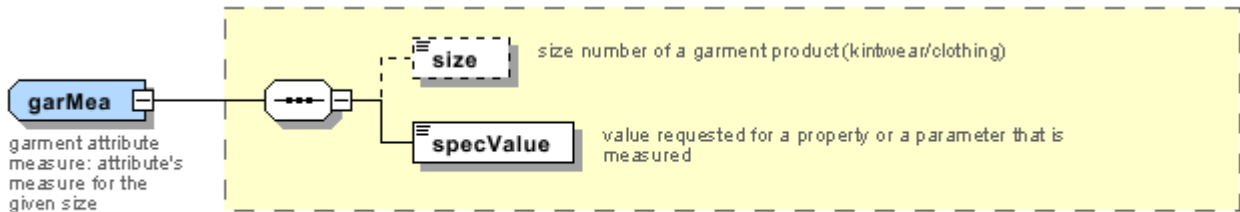
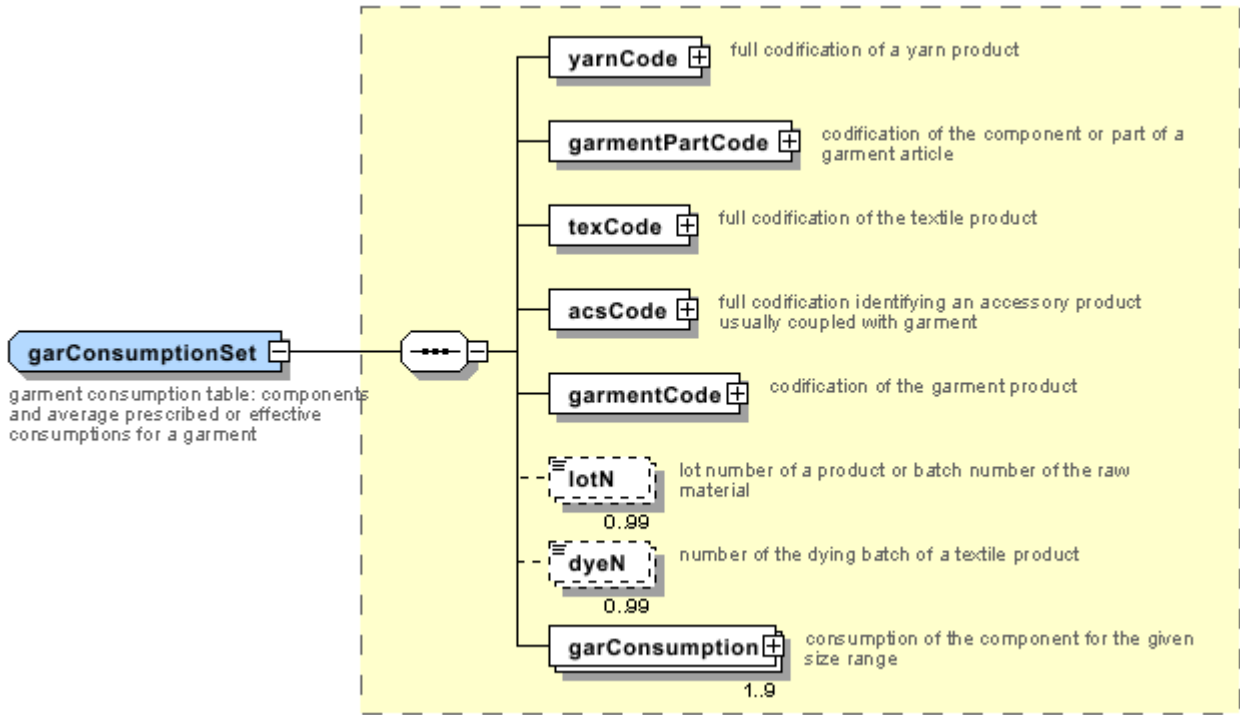



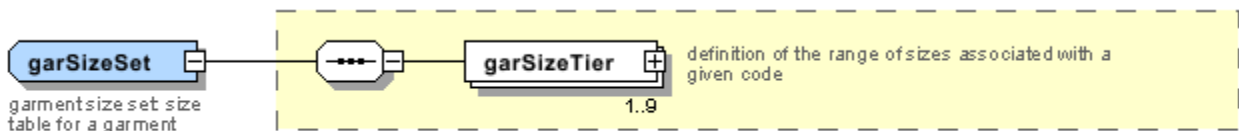
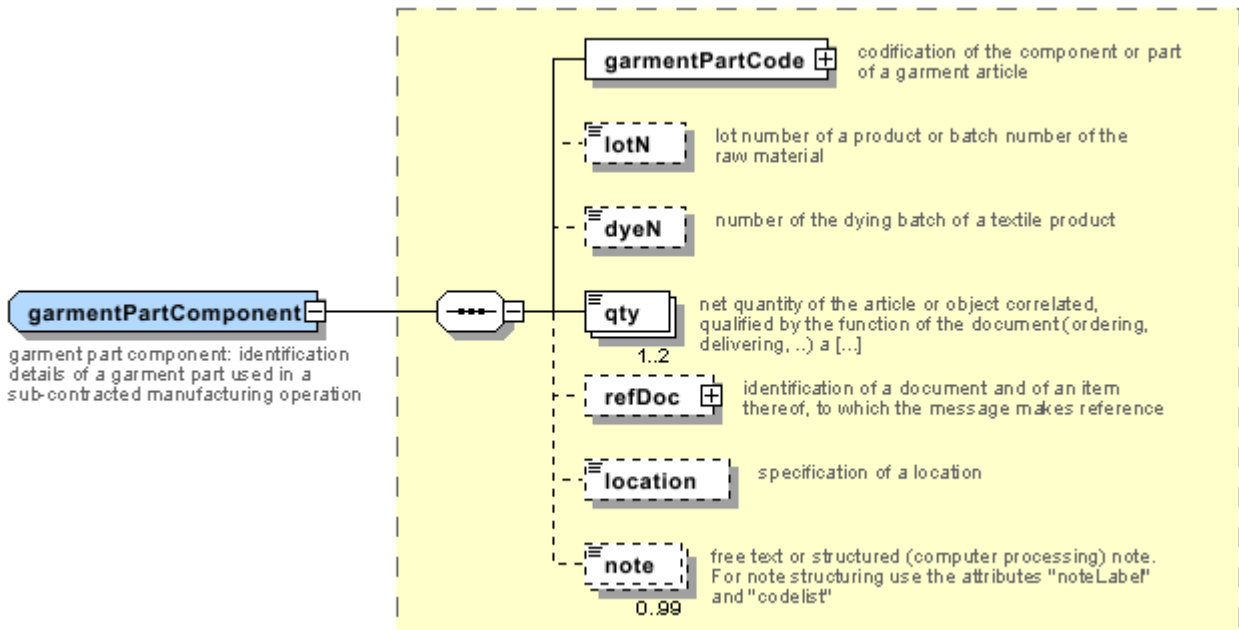
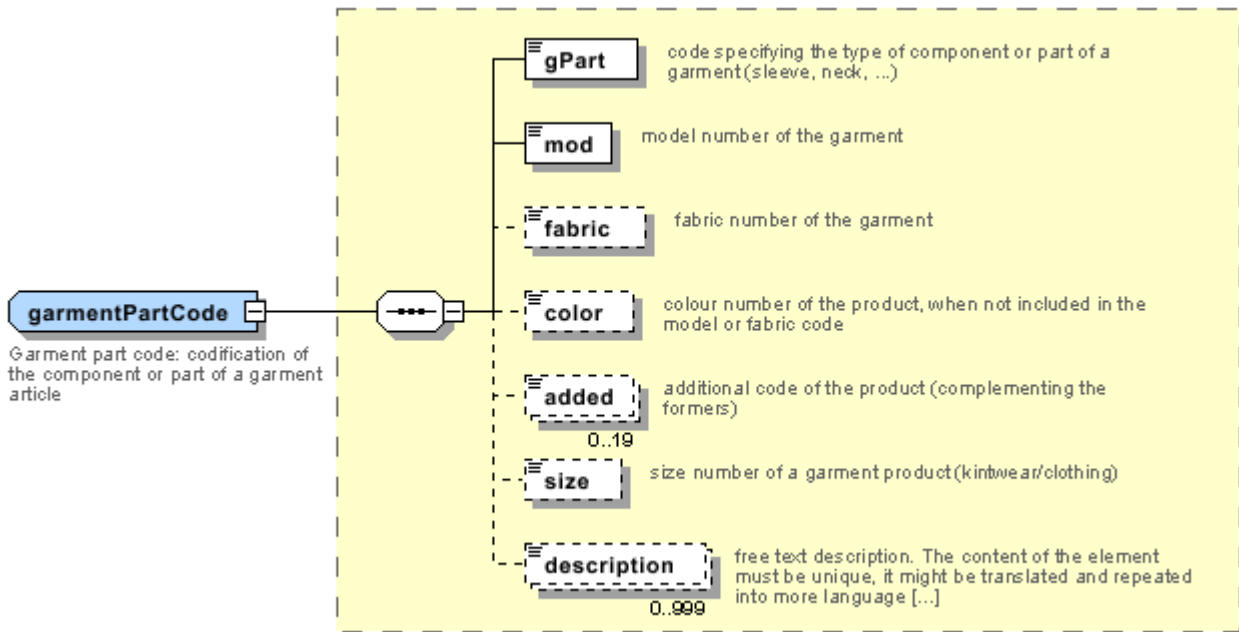

**garSizeTier**  
 garment size tier:  
 definition of the range of  
 sizes associated with a  
 given code

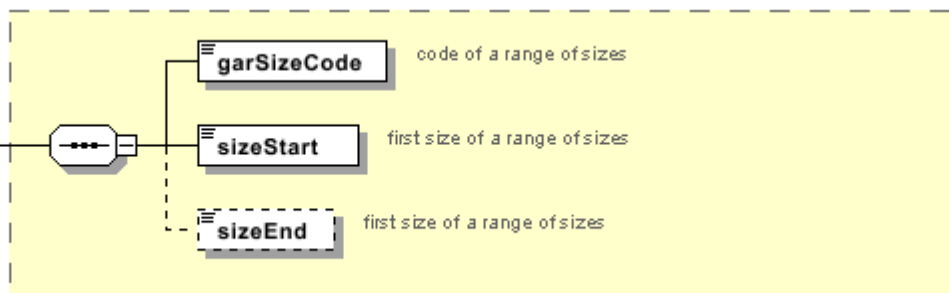

**garTecSheet**  
 garment technical sheet:  
 garment technical sheet

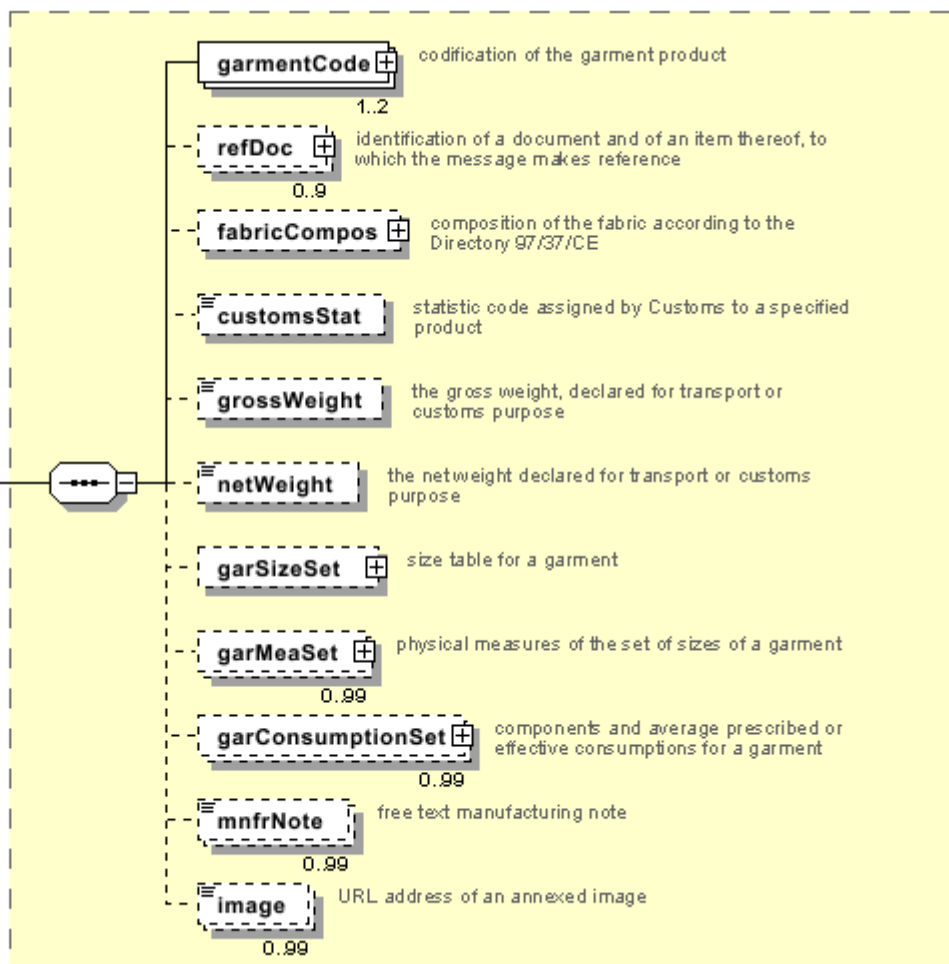

**KCCOheader**  
 KCCO header:  
 header of the  
 document GARMENT  
 COMMISSION ORDER

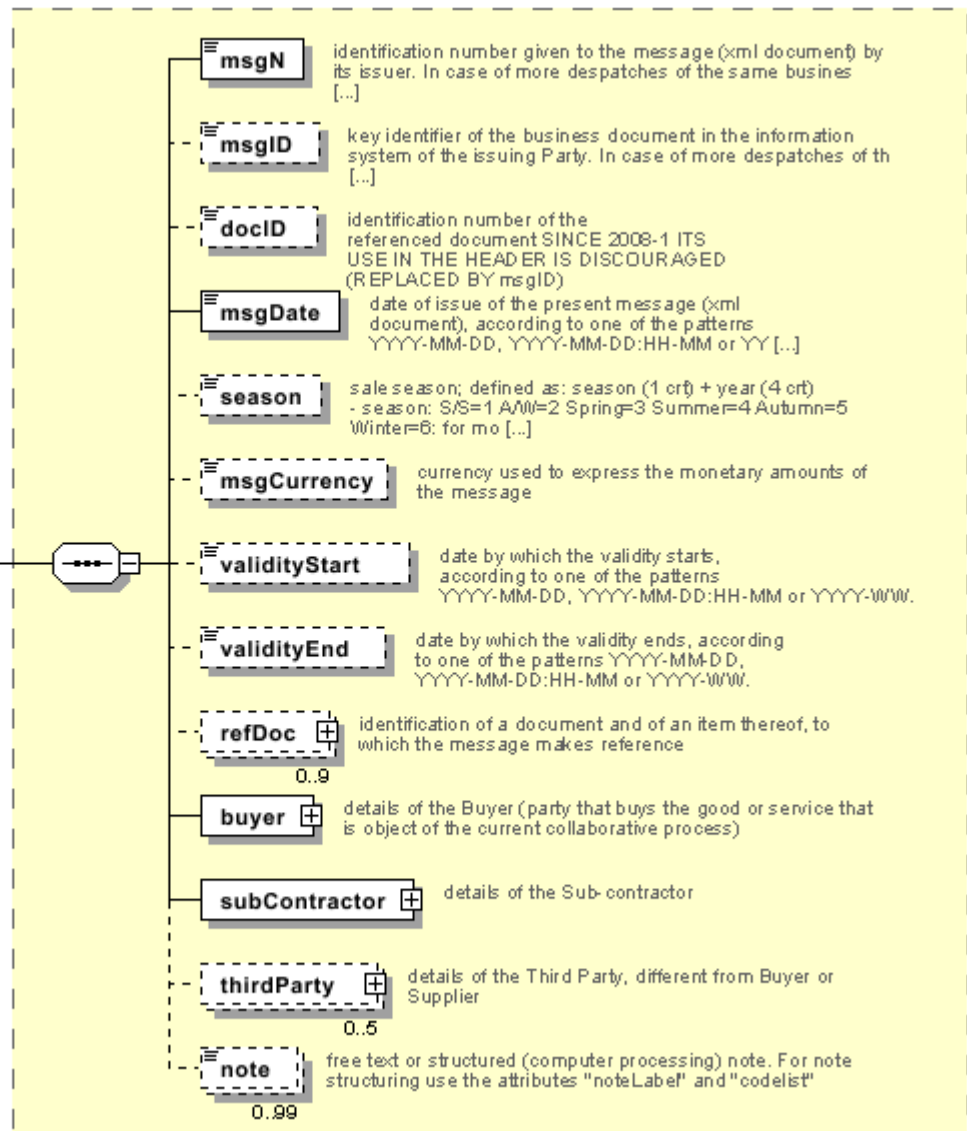

**KCCOitem**

KCCO item:  
line of the  
document  
GARMENT  
COMMISSION  
ORDER

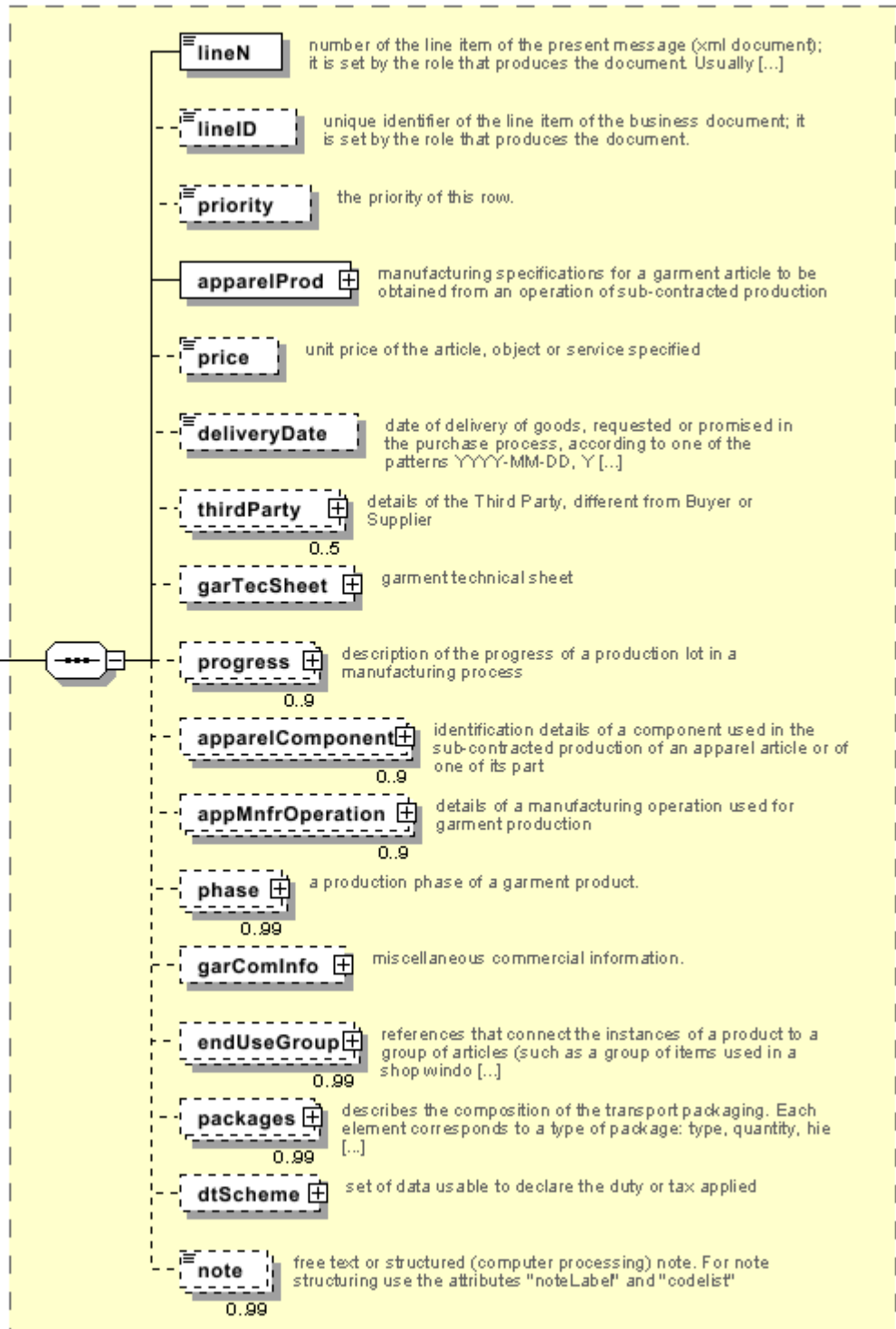

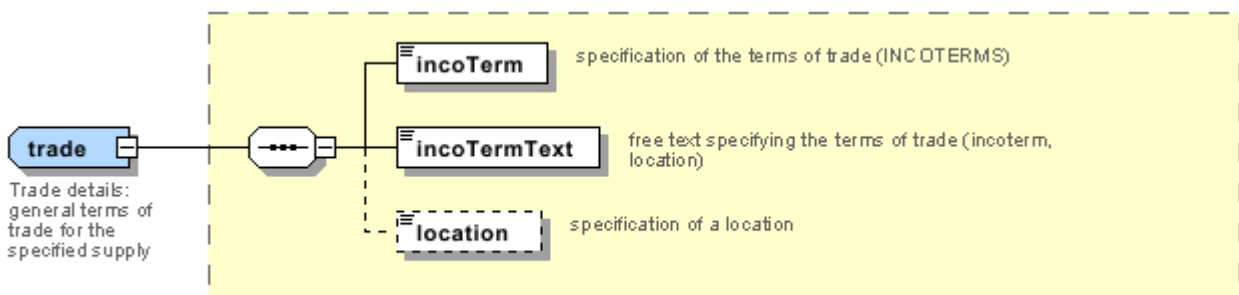
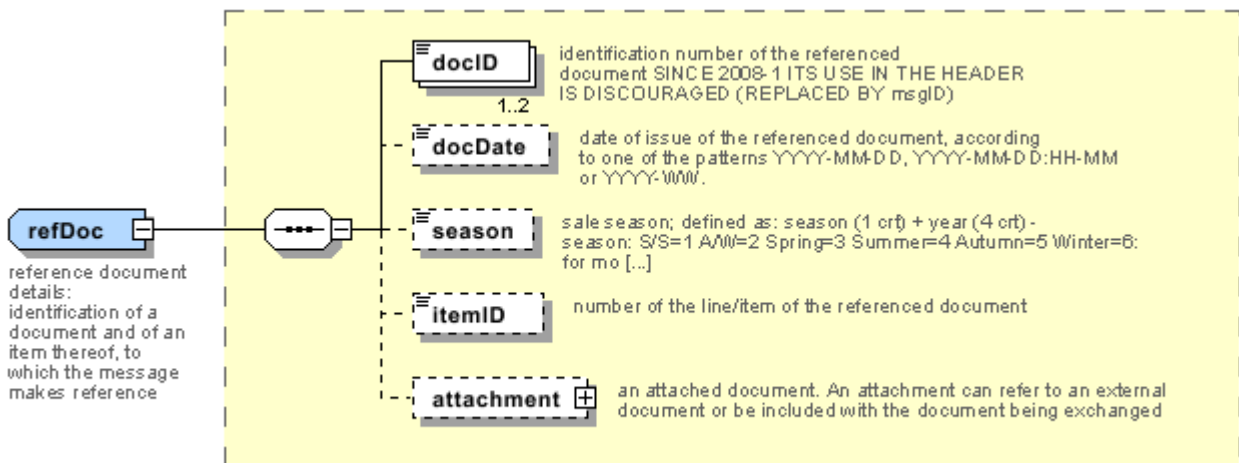
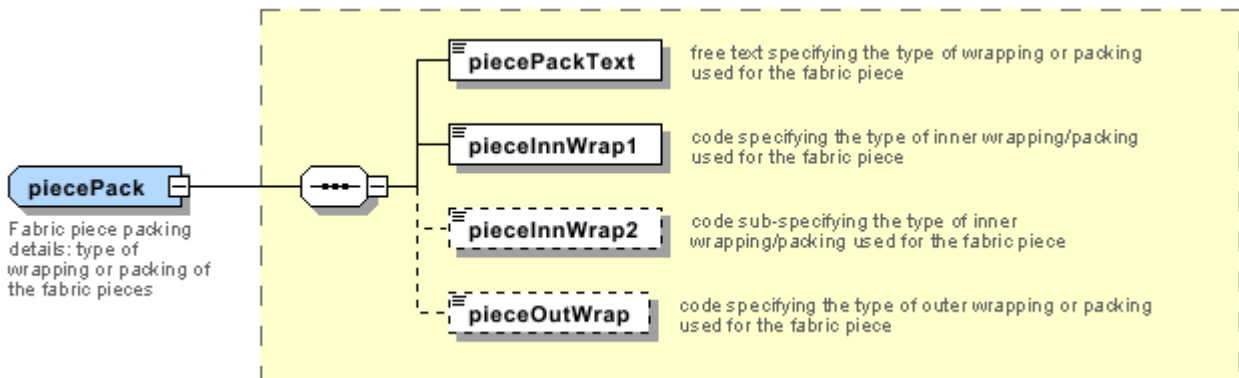
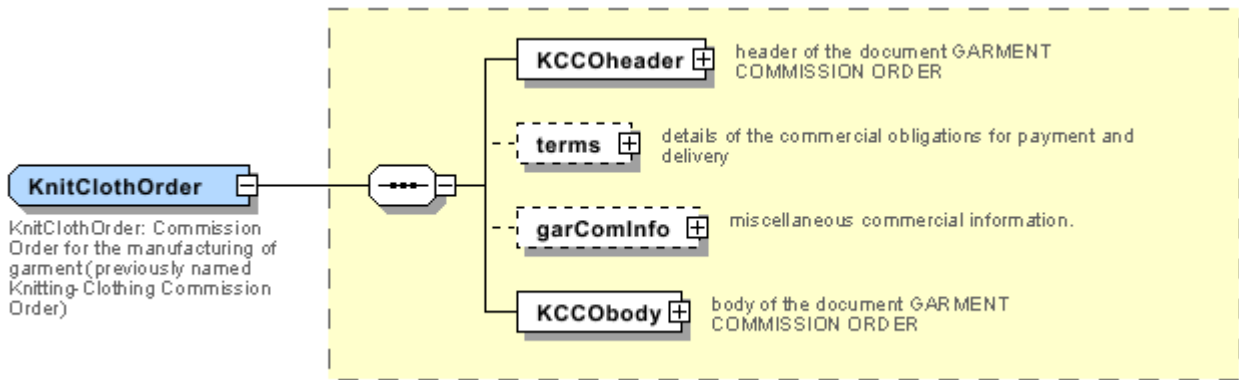

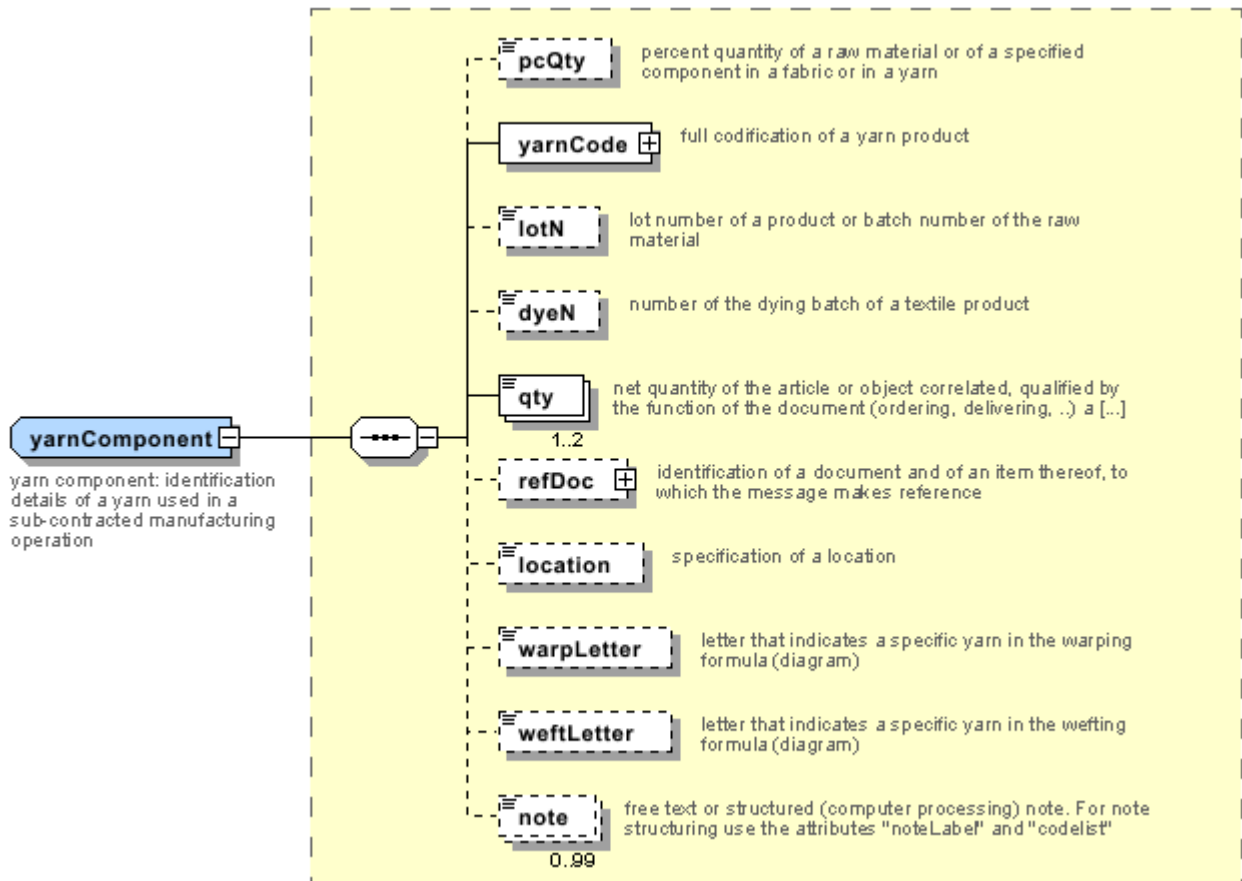



## Annex B

### NT1 - Order type

type of Order

Agency name: eBIZ

tabella cod.: NT1

File codes list (Generic code): [http://www.ebiz.enea.it/moda-ml/repository/codelist/draft/gc\\_NT1.xml](http://www.ebiz.enea.it/moda-ml/repository/codelist/draft/gc_NT1.xml)

Code	Description	Adoption note	Date of insertion
A	blanket	the order is open without a concrete delivery of product; it establishes an amount of goods to be produced in a future	
D	call-off	orders an amount of goods to be delivered (and invoiced and produced if necessary); it is important that it is clear that this amount should be subtracted from the amount of the blanket order referred in the refDoc element	
P	reservation		
STANDARD	standard		

### NT100 - eBIZ TCFUpstream version

dictionary version

Agency name: eBIZ

tabella cod.: NT100

File codes list (Generic code): [http://www.ebiz.enea.it/moda-ml/repository/codelist/draft/gc\\_NT100.xml](http://www.ebiz.enea.it/moda-ml/repository/codelist/draft/gc_NT100.xml)

Code	Description	Adoption note	Date of insertion
2013-1	v2013-1		01/07/2013
2018-1	v2018-1		04/11/2018
draft	draft		08/09/2017

### NT11 - transport causal

reason for the transport

Agency name: eBIZ



tabella cod.: NT11

File codes list (Generic code): [http://www.ebiz.enea.it/moda-ml/repository/codelist/draft/gc\\_NT11.xml](http://www.ebiz.enea.it/moda-ml/repository/codelist/draft/gc_NT11.xml)

Code	Description	Adoption note	Date of insertion
FOC	free of charge		
FRW	return from re-works		
FST	return from storage		
FVW	return from view		
FWK	return from works		
IST	in storage		
NWK	return non-worked		
RJC	return from rejection		
SEL	to sell		
STO	to storage		
VEW	to view		
WRK	to works		

#### NT12 - data source

party who has provided the data

Agency name: eBIZ

tabella cod.: NT12

File codes list (Generic code): [http://www.ebiz.enea.it/moda-ml/repository/codelist/draft/gc\\_NT12.xml](http://www.ebiz.enea.it/moda-ml/repository/codelist/draft/gc_NT12.xml)

Code	Description	Adoption note	Date of insertion
AC	internal test		
CO	external test		
CV	test after steaming		

#### NT16 - VAT rate or code

VAT rate or code ( DEPRECATED, use dtScheme element )

tabella cod.: NT16

File codes list (Generic code): [http://www.ebiz.enea.it/moda-ml/repository/codelist/draft/gc\\_NT16.xml](http://www.ebiz.enea.it/moda-ml/repository/codelist/draft/gc_NT16.xml)

#### NT18 - message function

function performed by the present message with regards to the transmission

Agency name: eBIZ

tabella cod.: NT18

File codes list (Generic code): [http://www.ebiz.enea.it/moda-ml/repository/codelist/draft/gc\\_NT18.xml](http://www.ebiz.enea.it/moda-ml/repository/codelist/draft/gc_NT18.xml)

Code	Description	Adoption note	Date of insertion
CA	delete this document		01/07/2013
CP	copy		
OR	original		
RC	re-transmission for data correction		
RT	re-transmission		

### NT2 - third party qualifier

Third Party role qualifier

Agency name: eBIZ

tabella cod.: NT2

File codes list (Generic code): [http://www.ebiz.enea.it/moda-ml/repository/codelist/draft/gc\\_NT2.xml](http://www.ebiz.enea.it/moda-ml/repository/codelist/draft/gc_NT2.xml)

Code	Description	Adoption note	Date of insertion
AG	Sales Agent		
CO	Quality Controller		
DC	Response to		
DF	Invoicce		
DI	Copy to (CC)		28/10/2014
DM	Consignee		
DP	Consignment address (Delivery Party)		
IM	Importer		
OR	Originator		10/09/2014
SP	Forwarder		
TX	Tax Representative		

### NT20 - price qualifier

type of price with reference to discount and taxes

Agency name: eBIZ

tabella cod.: NT20

File codes list (Generic code): [http://www.ebiz.enea.it/moda-ml/repository/codelist/draft/gc\\_NT20.xml](http://www.ebiz.enea.it/moda-ml/repository/codelist/draft/gc_NT20.xml)

Code	Description	Adoption note	Date of insertion
GET	gross excluding taxes		
GIT	gross including taxes		
NET	net excluding taxes		
NIT	net including taxes		

### NT22 - product type of an operation

level of the product (end or intermediate) yielded by an operation in a work cycle

Agency name: eBIZ

tabella cod.: NT22

File codes list (Generic code): [http://www.ebiz.enea.it/moda-ml/repository/codelist/draft/gc\\_NT22.xml](http://www.ebiz.enea.it/moda-ml/repository/codelist/draft/gc_NT22.xml)

Code	Description	Adoption note	Date of insertion
END	end-product		
INT	intermediate		

### NT29 - format of a date

format used for the date

Agency name: eBIZ

tabella cod.: NT29

File codes list (Generic code): [http://www.ebiz.enea.it/moda-ml/repository/codelist/draft/gc\\_NT29.xml](http://www.ebiz.enea.it/moda-ml/repository/codelist/draft/gc_NT29.xml)

Code	Description	Adoption note	Date of insertion
D	YYYY-MM-DD		
M	YYYY-MM-DD:HH-MM		
W	YYYY-WW		

### NT3 - data format

format of a string according to a customized User rule (local rule)

Agency name: eBIZ

tabella cod.: NT3

File codes list (Generic code): [http://www.ebiz.enea.it/moda-ml/repository/codelist/draft/gc\\_NT3.xml](http://www.ebiz.enea.it/moda-ml/repository/codelist/draft/gc_NT3.xml)

Code	Description	Adoption note	Date of insertion
EN4	GS1-GLN		01/07/2013
MD	mutually agreed		

### NT37 - committed quantity qualifier

specifies if the committed quantity can or can not include the loss in weight

Agency name: eBIZ

tabella cod.: NT37

File codes list (Generic code): [http://www.ebiz.enea.it/moda-ml/repository/codelist/draft/gc\\_NT37.xml](http://www.ebiz.enea.it/moda-ml/repository/codelist/draft/gc_NT37.xml)

Code	Description	Adoption note	Date of insertion
NS	quantity can include losses		
SA	quantity can not include losses		

### NT39 - consumption type

indicates what the indicated consumption quantity is referred to

Agency name: eBIZ

tabella cod.: NT39

File codes list (Generic code): [http://www.ebiz.enea.it/moda-ml/repository/codelist/draft/gc\\_NT39.xml](http://www.ebiz.enea.it/moda-ml/repository/codelist/draft/gc_NT39.xml)

Code	Description	Adoption note	Date of insertion
BOL	required quantity to obtain the indicated total amount of product (Bill of Loading)		25/07/2018
BO M	required quantity for unit of product (Bill of material)		25/07/2018

### NT4 - end use

specifies the final use of the product

Agency name: eBIZ

tabella cod.: NT4

File codes list (Generic code): [http://www.ebiz.enea.it/moda-ml/repository/codelist/draft/gc\\_NT4.xml](http://www.ebiz.enea.it/moda-ml/repository/codelist/draft/gc_NT4.xml)

Code	Description	Adoption note	Date of insertion
PC	test piece		
PR	production		
SA	Sample		10/09/2014
SC	samples card		
TI	patch		
TP	(test cut)		

#### NT40 - manufacturing note qualifiers

qualifier of the product treated in the note

Agency name: eBIZ

tabella cod.: NT40

File codes list (Generic code): [http://www.ebiz.enea.it/moda-ml/repository/codelist/draft/gc\\_NT40.xml](http://www.ebiz.enea.it/moda-ml/repository/codelist/draft/gc_NT40.xml)

Code	Description	Adoption note	Date of insertion
AD	adhesives		
BT	buttons		
CU	seams		
IB	packing		
LA	washing		
ST	ironing		

#### NT41 - garment attributes

garment's attribute to which the measures are referred

Agency name: eBIZ

tabella cod.: NT41

File codes list (Generic code): [http://www.ebiz.enea.it/moda-ml/repository/codelist/draft/gc\\_NT41.xml](http://www.ebiz.enea.it/moda-ml/repository/codelist/draft/gc_NT41.xml)

Code	Description	Adoption note	Date of insertion
C	neck center sleeve length		
CL	neck		

CV	crotch		
E	under-sleeve length		
F	raglan in front		
FC	hips		
G	muscle		
GM	sleeve ride		
H	bottom edge height		
I	cuff height		
L	neck edge height		
LG	width		
LM	sleeve length		
LN	length		
M	neck opening		
N	coppino		
O	sleeve width to 10 cm		
P	bottom width		
SP	shoulders		
VT	waist		

### NT43 - operational code qualifier

Agency name: eBIZ

tabella cod.: NT43

File codes list (Generic code): [http://www.ebiz.enea.it/moda-ml/repository/codelist/draft/gc\\_NT43.xml](http://www.ebiz.enea.it/moda-ml/repository/codelist/draft/gc_NT43.xml)

Code	Description	Adoption note	Date of insertion
1	event		08/09/2017
2	sales channel		08/09/2017
3	goods management type		08/09/2017
4	special initiative		08/09/2017

### NT51 - Filling Criterion for Package homogeneity

Filling Criterion for Package homogeneity

Agency name: eBIZ

tabella cod.: NT51

File codes list (Generic code): [http://www.ebiz.enea.it/moda-ml/repository/codelist/draft/gc\\_NT51.xml](http://www.ebiz.enea.it/moda-ml/repository/codelist/draft/gc_NT51.xml)

Code	Description	Adoption note	Date of insertion
COL	Colour		08/09/2017
MOD	Model		08/09/2017
SIZ	Size		08/09/2017

#### NT6 - coding system owner/issuer

code specifying the organisation who has created or owns the coding or numbering system

Agency name: eBIZ

tabella cod.: NT6

File codes list (Generic code): [http://www.ebiz.enea.it/moda-ml/repository/codelist/draft/gc\\_NT6.xml](http://www.ebiz.enea.it/moda-ml/repository/codelist/draft/gc_NT6.xml)

Code	Description	Adoption note	Date of insertion
CL	Customer/buyer		
CO	Quality Controller		
EN	GS1 ( ex-EAN International )		
ES	e-Stockflow		
FO	Supplier		
GS	GS1		01/07/2013
MF	VAT identifier		
ML	Moda-ML		
SP	Service Provider		

#### NT7 - unit of measure

specification of the unit of measure, it is a sub set of table Unit of Measure Code - UN/ECE REC 20 delivered by United Nations Economic Commission for Europe (UN/ECE)

Agency name: eBIZ / UN/ECE

tabella cod.: NT7

File codes list (Generic code): [http://www.ebiz.enea.it/moda-ml/repository/codelist/draft/gc\\_NT7.xml](http://www.ebiz.enea.it/moda-ml/repository/codelist/draft/gc_NT7.xml)

Other link: <http://docs.oasis-open.org/ubl/os-UBL-2.1/cl/gc/default/UnitOfMeasureCode-2.1.gc#>

Code	Description	Adoption note	Date of insertion
CMK	square centimetre		20/12/2017

CMQ	cubic centimetre		20/12/2017
CMT	centimetre		
CNE	centiNewton		
CO2TON	ton of CO2		10/09/2014
COUPLES	couples		
DMQ	cubic decimetre		
E37	pixel		11/04/2018
GRM	gram		
HUR	hour		
INH	inch		
KGM	kilogram		
KMT	kilometer		
KWH	kilowatthours		10/09/2014
LBR	pound		
MIN	minute		
MMK	centimetre		20/12/2017
MMK	square millimetre		20/12/2017
MTK	square metre		20/12/2017
MTQ	cubic metre		
MTR	metre		
NMB	numero		
ONZ	ounce		
P1	percent		
PPM	parts per milion		
PZ	piece		
RPM	rounds per metre		
YRD	yard		

### T1 - terms of payment

code specifying the terms or time by which the payment must be done

Agency name: eBIZ

tabella cod.: T1

File codes list (Generic code): [http://www.ebiz.enea.it/moda-ml/repository/codelist/draft/gc\\_T1.xml](http://www.ebiz.enea.it/moda-ml/repository/codelist/draft/gc_T1.xml)

Code	Description	Adoption note	Date of insertion
------	-------------	---------------	-------------------



ANTICIP	PAYMENT IN ADVANCE		
BLCOLLECT/120D	BILL OF LADING 120 DD		
BLCOLLECT/30D	BILL OF LADING 30 DD		
BLCOLLECT/60D	BILL OF LADING 60 DD		
BLCOLLECT/90D	BILL OF LADING 90 DD		
CASH	PAYMENT ON DELIVERY		
CASHINV	PAYMENT ON RECEIPT OF INVOICE		
CREDOC/0D	DOCUMENTARY CREDIT FOR PAYM. AT SIGHT		
CREDOC/120	DOCUMENTARY CREDIT FOR PAYM. AT 120 DD		
CREDOC/150	DOCUMENTARY CREDIT FOR PAYM. AT 150 DD		
CREDOC/180	DOCUMENTARY CREDIT FOR PAYM. AT 180 DD		
CREDOC/30D	DOCUMENTARY CREDIT FOR PAYM. AT 30 DD		
CREDOC/45D	DOCUMENTARY CREDIT FOR PAYM. AT 45 DD		
CREDOC/60	DOCUMENTARY CREDIT FOR PAYM. AT 60 DD		
CREDOC/90	DOCUMENTARY CREDIT FOR PAYM. AT 90 DD		
DEL/10	PAYMENT AT 10 DD AFTER DELIVERY		
DOCOLLECT/120D	DOCUMENTARY COLLECTION AT 120 DD		
DOCOLLECT/30D	DOCUMENTARY COLLECTION AT 30 DD		
DOCOLLECT/60D	DOCUMENTARY COLLECTION AT 60 DD		
DOCOLLECT/90D	DOCUMENTARY COLLECTION AT 90 DD		
INV/120D	PAYMENT AT 120 DD AFTER RECEIPT OF INVOICE		
INV/150D	PAYMENT AT 150 DD AFTER RECEIPT OF INVOICE		
INV/180D	PAYMENT AT 180 DD AFTER RECEIPT OF INVOICE		
INV/30D	PAYMENT AT 30 DD AFTER RECEIPT OF INVOICE		
INV/45D	PAYMENT AT 45 DD AFTER RECEIPT OF INVOICE		
INV/60D	PAYMENT AT 60 DD AFTER RECEIPT OF INVOICE		
INV/90D	PAYMENT AT 90 DD AFTER RECEIPT OF INVOICE		
INVULTIMO	PAYMENT AT END MONTH RECEIPT INVOICE		
INVULTIMO/10D	PAYMENT 10 DD AFTER END MONTH RECEIPT INVOICE		
INVULTIMO/120D	PAYMENT 120 DD AFTER END MONTH RECEIPT INVOICE		
INVULTIMO/150D	PAYMENT 150 DD AFTER END MONTH RECEIPT INVOICE		
INVULTIMO/180D	PAYMENT 180 DD AFTER END MONTH RECEIPT INVOICE		
INVULTIMO/240D	PAYMENT 240 DD AFTER END MONTH RECEIPT INVOICE		
INVULTIMO/30D	PAYMENT 30 DD AFTER END MONTH RECEIPT INVOICE		
INVULTIMO/45D	PAYMENT 45 DD AFTER END MONTH RECEIPT INVOICE		

INVULTIMO/60D	PAYMENT 60 DD AFTER END MONTH RECEIPT INVOICE		
INVULTIMO/90D	PAYMENT 90 DD AFTER END MONTH RECEIPT INVOICE		
NOPAY	WITHOUT PAYMENT		
RECREDOC/0D	IRREVOC. DOCUMENTARY CREDIT FOR PAYM. AT SIGHT		
RECREDOC/120D	IRREVOC. DOCUMENTARY CREDIT FOR PAYM. AT 120 DD		
RECREDOC/150D	IRREVOC. DOCUMENTARY CREDIT FOR PAYM. AT 150 DD		
RECREDOC/180D	IRREVOC. DOCUMENTARY CREDIT FOR PAYM. AT 180 DD		
RECREDOC/30D	IRREVOC. DOCUMENTARY CREDIT FOR PAYM. AT 30 DD		
RECREDOC/45D	IRREVOC. DOCUMENTARY CREDIT FOR PAYM. AT 45 DD		
RECREDOC/60D	IRREVOC. DOCUMENTARY CREDIT FOR PAYM. AT 60 DD		
RECREDOC/90D	IRREVOC. DOCUMENTARY CREDIT FOR PAYM. AT 90 DD		
ULTIMO	PAYMENT BY END MONTH OF DELIVERY		
ULTIMO/10	PAYMENT AT 10 DD AFTER END MONTH OF DELIVERY		

### T10 - ISO3166 - Country

code of the nation

Agency name: ISO

tabella cod.: T10

File codes list (Generic code): [http://www.ebiz.enea.it/moda-ml/repository/codelist/draft/gc\\_T10.xml](http://www.ebiz.enea.it/moda-ml/repository/codelist/draft/gc_T10.xml)

Table not printed: there are 239 elements, more than the maximum specified for printing: 99.

### T11 - transport package type

code specifying the type of package used for transport and delivery (subset of UN/ECE 8053 and UBL TransportEquipmentTypeCode-2.1)

Agency name: eBIZ

tabella cod.: T11

File codes list (Generic code): [http://www.ebiz.enea.it/moda-ml/repository/codelist/draft/gc\\_T11.xml](http://www.ebiz.enea.it/moda-ml/repository/codelist/draft/gc_T11.xml)

Other link: <http://docs.oasis-open.org/ubl/os-UBL-2.1/cl/gc/default/TransportEquipmentTypeCode-2.1.gc#>

Code	Description	Adoption note	Date of insertion
4A	box, steel		
4C	box, wood		
4G	Box, fibreboard		01/08/2018
4H	Box, plastic		01/08/2018

5H	Bag, woven plastic		01/08/2018
5L	Bag, textile		01/08/2018
5M	Bag, paper		
AJ	Cone		01/08/2018
BL	Bale, compressed		01/08/2018
BN	Bale, non-compressed		01/08/2018
BX	Box		
CI	Canister		01/08/2018
CL	Coil		01/08/2018
CN	Container, not otherwise specified as transport equipment		01/08/2018
CS	Case		01/08/2018
CT	Carton		01/08/2018
EC	Bag, plastic		01/08/2018
ED	Case, with pallet base		01/08/2018
EE	Case, with pallet base, wooden		01/08/2018
EF	Case, with pallet base, cardboard		01/08/2018
EG	Case, with pallet base, plastic		01/08/2018
EH	Case, with pallet base, metal		01/08/2018
FX	Bag, flexible container		01/08/2018
HN	Hanger		01/08/2018
NE	unpacked		
NF	Unpacked or unpackageged, single unit		01/08/2018
NG	Unpacked or unpackageged, multiple units		01/08/2018
OA	Pallet, CHEP 40 cm x 60 cm		01/08/2018
OB	Pallet, CHEP 80 cm x 120 cm		01/08/2018
OC	Pallet, CHEP 100 cm x 120 cm		01/08/2018
OD	Pallet, AS 4068-1993		01/08/2018
OE	Pallet, ISO T11		01/08/2018
PE	europallet (80x120)		
PX	pallet		
QS	box, plastic, solid		
RJ	Rack, clothing hanger		01/08/2018
RL	Reel		01/08/2018
SO	Spool		01/08/2018
TU	tube		

XD	bag, plastics film		
XK	bag,paper, multi-wall, water resistant		
ZZ	Mutually defined		01/08/2018

### T19 - fibre type

type of fibre used in a textile product

Agency name: eBIZ

tabella cod.: T19

File codes list (Generic code): [http://www.ebiz.enea.it/moda-ml/repository/codelist/draft/gc\\_T19.xml](http://www.ebiz.enea.it/moda-ml/repository/codelist/draft/gc_T19.xml)

Code	Description	Adoption note	Date of insertion
AB	abaca		20/08/2018
AC	acetate		
AF	other fibres		
AG	alginic fibre		
AL	alfa		20/08/2018
CA	hemp		
CC	coir (coconut)		20/08/2018
CL	chlorofibre		
CO	cotton		
CU	cuprous		
EA	elastan		
EL	Elastodiene		20/08/2018
FL	fluorofibre		
GI	broom		20/08/2018
GL	textile glass		
HA	hair		20/08/2018
HE	henequen		20/08/2018
HL	mixed linen		
HL	cotton linen union		20/08/2018
JU	jute		
KE	kenaf		20/08/2018
KP	kapoc		20/08/2018
LI	linen		
LY	lyocell		20/08/2018

MA	modacrylic		
MD	modal		
ME	metallized		
MG	maguey		20/08/2018
PA	polyamide		
PB	polyureic		
PC	acrylic		
PE	polyethylene		
PI	paper		20/08/2018
PL	polyester		
PM	polyimide		
PP	polypropylene		
PR	proteic		
PU	polyurethane		
RA	mamie		20/08/2018
SE	silk		
SI	sisal		20/08/2018
SN	sun		20/08/2018
TA	triacetate		
TR	textile residues or unspecified composition		20/08/2018
TV	trivinyll		
VI	viscose		
VY	vinylal		
WA	angora		
WB	beaver		20/08/2018
WC	cashgora		
WG	vicuna		
WK	camel		
WL	llama		
WM	mohair		
WN	lapin		20/08/2018
WO	wool		
WP	alpaca		
WS	cashmere		
WT	Oteer		20/08/2018

WU	guanaco		
WV	virgin wool		
WY	yack		

## T2 - Modes of payment

way or means of payment

Agency name: eBIZ

tabella cod.: T2

File codes list (Generic code): [http://www.ebiz.enea.it/moda-ml/repository/codelist/draft/gc\\_T2.xml](http://www.ebiz.enea.it/moda-ml/repository/codelist/draft/gc_T2.xml)

Code	Description	Adoption note	Date of insertion
BB	bank transfer		
IA	collection through Agent		
IS	collection through Forwarder		
RB	bank receipt		
RD	remittance		
SW	bank SWIFT		
TR	bank draft		

## T205 - type of job in knitting/clothing

operation of a work cycle for knitting/clothing

Agency name: eBIZ

tabella cod.: T205

File codes list (Generic code): [http://www.ebiz.enea.it/moda-ml/repository/codelist/draft/gc\\_T205.xml](http://www.ebiz.enea.it/moda-ml/repository/codelist/draft/gc_T205.xml)

Code	Description	Adoption note	Date of insertion
10	cutting		
20	sewing		
30	manufacturing		
40	washing		
50	ironing		
60	packing		

## T21 - type of document

type or class to which the referenced document belongs

Agency name: eBIZ

tabella cod.: T21

File codes list (Generic code): [http://www.ebiz.enea.it/moda-ml/repository/codelist/draft/gc\\_T21.xml](http://www.ebiz.enea.it/moda-ml/repository/codelist/draft/gc_T21.xml)

Code	Description	Adoption note	Date of insertion
BOR	blanket order		01/02/2018
CAT	Price catalogue - tech sheet		
CEO	Certificate of origin		13/04/2018
CER	Certificate		13/04/2018
COC	colour card		
CRN	Credit note		08/09/2017
CTO	Checking order		01/07/2013
CTR	Contract		
CXF	CxF3 file		01/07/2013
DAD	Darn order		
DDT	ddt		
DEA	Despatch advise		
DER	Despatch request		
DR	Document Request		02/12/2014
FOR	Forecast		02/12/2014
GSO	Garment stock offer		
GSX	Garment stock offer change		
INV	Invoice		
KCC	Knitting-Clothing Commission Order		02/12/2014
KCI	Garment in Work Inventory Report		02/12/2014
M2M	Made to Measure Production Order		02/12/2014
MAS	Master marker		
MCI	Visual merchandising instruction		13/04/2018
OCH	Order change		
OFF	Offer		
ORD	Purchase order		
ORP	Order response		
OSR	order status request		

OSS	Offer status		02/12/2014
OST	Order status		
OUR	our reference		
QR	Quality Report		02/12/2014
RAI	Raw Material in Work Inventory Report		02/12/2014
RDC	Raw dyeing commission order		
RDH	Raw dyeing order change		
RDR	Raw dyeing order response		
REA	Receiving advise		
REQ	Request for Offer		
RET	Return		02/12/2014
RSC	Spinning commission order		
RSH	Spinning order change		
RSR	Spinning order response		
SCL	process sheet		
TFC	Textile dyeing-finishing commission order		
TFX	Textile Dyeing-Finishing Order Change		02/12/2014
TPC	Textile printing commission order		
TPX	Textile Printing Order Change		02/12/2014
TWI	Textile in work inventory		
VMI	visual merchandising instructions		01/02/2018
WAC	Warping commission order		
WEC	Weaving commission order		
YDC	Yarn dyeing commission order		
YDH	Yarn dyeing order change		
YDR	Yarn dyeing order response		
YTC	Twisting commission order		
YWI	Yarn in work inventory		

### **T265 - type of job technology in knitting/clothing**

operation technology for knitting/clothing

Agency name: eBIZ

tabella cod.: T265

File codes list (Generic code): [http://www.ebiz.enea.it/moda-ml/repository/codelist/draft/gc\\_T265.xml](http://www.ebiz.enea.it/moda-ml/repository/codelist/draft/gc_T265.xml)



Code	Description	Adoption note	Date of insertion
00	to be developed		

### T275 - type of machine for knitting/clothing

machine used in an operation of a work cycle for knitting/clothing

Agency name: eBIZ

tabella cod.: T275

File codes list (Generic code): [http://www.ebiz.enea.it/moda-ml/repository/codelist/draft/gc\\_T275.xml](http://www.ebiz.enea.it/moda-ml/repository/codelist/draft/gc_T275.xml)

Code	Description	Adoption note	Date of insertion
PF	PAFF		

### T29 - type of yarn package

type of package (roll-up) used for a yarn product

Agency name: eBIZ

tabella cod.: T29

File codes list (Generic code): [http://www.ebiz.enea.it/moda-ml/repository/codelist/draft/gc\\_T29.xml](http://www.ebiz.enea.it/moda-ml/repository/codelist/draft/gc_T29.xml)

Code	Description	Adoption note	Date of insertion
CIL	bobbin		
CON	cone		
HNK	hank, skein		01/07/2013
MUF	muff, cake		01/07/2013
SPL	spool		
TUB	tube		
XCO	supercone		

### T3 - terms of delivery

specification of the terms of trade (INCOTERMS)

Agency name: Incoterms

tabella cod.: T3

File codes list (Generic code): [http://www.ebiz.enea.it/moda-ml/repository/codelist/draft/gc\\_T3.xml](http://www.ebiz.enea.it/moda-ml/repository/codelist/draft/gc_T3.xml)

Code	Description	Adoption note	Date of insertion
CFR	COST AND FREIGHT (named port of destination)		
CIF	COST, INSURANCE AND FREIGHT (named port of destination)		
CIP	CARRIAGE AND INSURANCE PAID (named place of destination)		
CP T	CARRIAGE PAID (named place of destination)		
DAF	DELIVERED AT FRONTIER (named place)	according to Incoterms® 2010 it is obsolete	08/12/2017
DAP	Delivered at Place of destination (named place of destination)	according to Incoterms® 2010	08/12/2017
DAT	Delivered at Terminal (named place of destination)	according to Incoterms® 2010	08/12/2017
DDP	DELIVERED DUTY PAID (named place of destination)		
DDU	DELIVERED DUTY UNPAID (named place of destination)	according to Incoterms® 2010 it is obsolete, use DAP	08/12/2017
DEQ	DELIVERED EX-QUAY (named port of destination)	according to Incoterms® 2010 it is obsolete	08/12/2017
DES	DELIVERED EX-SHIP (named port of destination)	according to Incoterms® 2010 it is obsolete	08/12/2017
EXW	EX WORKS (named place)		
FAS	FREE ALONGSIDE SHIP (named port of shipment)		
FCA	FREE CARRIER (named place)		
FOB	FREE ON BOARD (named port of shipment)		

### T30 - support of yarn package - material

type of material of which a package for yarn is made

Agency name: eBIZ

tabella cod.: T30

File codes list (Generic code): [http://www.ebiz.enea.it/moda-ml/repository/codelist/draft/gc\\_T30.xml](http://www.ebiz.enea.it/moda-ml/repository/codelist/draft/gc_T30.xml)

Code	Description	Adoption note	Date of insertion
CA	cartoon		

DY	for soft package dyeing		
MT	metallic		01/07/2013
PL	plastic		

### T32 - yarn reel wrapping type

type of wrapping in which a package of yarn is wrapped

Agency name: eBIZ

tabella cod.: T32

File codes list (Generic code): [http://www.ebiz.enea.it/moda-ml/repository/codelist/draft/gc\\_T32.xml](http://www.ebiz.enea.it/moda-ml/repository/codelist/draft/gc_T32.xml)

Code	Description	Adoption note	Date of insertion
XA	without bag		
XB	paper bag		01/07/2013
XD	plastic film bag		

### T33 - yarn outer packing

code specifying the type of outer wrapping or packing of a yarn

Agency name: eBIZ

tabella cod.: T33

File codes list (Generic code): [http://www.ebiz.enea.it/moda-ml/repository/codelist/draft/gc\\_T33.xml](http://www.ebiz.enea.it/moda-ml/repository/codelist/draft/gc_T33.xml)

Code	Description	Adoption note	Date of insertion
00			
CB	cartoon box		
CC	cartoon box 18 reels		
CD	cartoon box 36 reels		
XD	plastic film		

### T38 - transport conditions

special condition of transport or special service requested to the Forwarder

tabella cod.: T38

File codes list (Generic code): [http://www.ebiz.enea.it/moda-ml/repository/codelist/draft/gc\\_T38.xml](http://www.ebiz.enea.it/moda-ml/repository/codelist/draft/gc_T38.xml)

Code	Description	Adoption note	Date of insertion
ACC	arrange customs clearance		
CAL	Carrier loads		
CAU	Carrier unloads		
CMR	CMR carnet		
FFN	freight forwarders national conditions		
FLD	special agreement for full loading		
NCC	do not arrange customs clearance		
PPB	packaging paid by Buyer		
PPS	packaging paid by Supplier		
PRO	proof of delivery		
RFR	return container free		
RPC	return container paid by Customer		
RPS	return container paid by Supplier		
SHL	Shipper loads		
SHU	Consignee unloads		

#### T4 - fabric piece inner packing (wrapping) 1

code specifying the type of inner wrapping/packing used for the fabric piece

Agency name: eBIZ

tabella cod.: T4

File codes list (Generic code): [http://www.ebiz.enea.it/moda-ml/repository/codelist/draft/gc\\_T4.xml](http://www.ebiz.enea.it/moda-ml/repository/codelist/draft/gc_T4.xml)

Code	Description	Adoption note	Date of insertion
A	Folded, whole width		
B	Folded, doubled		
C	Folded, tube products		
D	Spoiled, whole width		
E	Spoiled, doubled, pli: left		
F	Spoiled, doubled, pli: right		
G	Rolled, whole width, single item		
H	Rolled, whole width, several items		
I	Rolled, doubled		
J	Rolled, tube products		

#### T40 - type of transport means

means of transport, in general or referred to a specific leg

Agency name: eBIZ

tabella cod.: T40

File codes list (Generic code): [http://www.ebiz.enea.it/moda-ml/repository/codelist/draft/gc\\_T40.xml](http://www.ebiz.enea.it/moda-ml/repository/codelist/draft/gc_T40.xml)

Code	Description	Adoption note	Date of insertion
AIR	aircraft		
SHP	ship		
TRU	truck		
VAN	van		

#### T41 - type of Allowance or Charge

coded specification of an Allowance or Charge (elaborated from UNECE 4465)

Agency name: eBIZ

tabella cod.: T41

File codes list (Generic code): [http://www.ebiz.enea.it/moda-ml/repository/codelist/draft/gc\\_T41.xml](http://www.ebiz.enea.it/moda-ml/repository/codelist/draft/gc_T41.xml)

Code	Description	Adoption note	Date of insertion
1	Agreed settlement		19/08/2018
10	Costs for draft		19/08/2018
11	Bank charges	DEPRECATED, use C BK	19/08/2018
12	Agent commission		19/08/2018
14	Wrong delivery		19/08/2018
15	Goods returned to agent		19/08/2018
16	Goods partly returned		19/08/2018
17	Transport damage		19/08/2018

19	Trade discount		19/08/2018
2	Below specification goods		19/08/2018
20	Deduction for late delivery	DEPRECATED, use C WB	19/08/2018
21	Advertising costs		19/08/2018
22	Customs duties		19/08/2018
23	Telephone and postal costs		19/08/2018
24	Repair costs		19/08/2018
25	Attorney fees		19/08/2018
26	Taxes		19/08/2018
3	Damaged goods		19/08/2018
30	Direct payment to seller		19/08/2018
32	Goods not delivered		19/08/2018
33	Late delivery		19/08/2018
35	Goods returned		19/08/2018
36	Invoice not received		19/08/2018
37	Credit note to debtor/not to us		19/08/2018
38	Deducted bonus		19/08/2018
39	Deducted discount		19/08/2018
4	Short delivery		19/08/2018
40	Deducted freight costs		19/08/2018
41	Deduction against other invoices		19/08/2018
42	Credit balance(s)		19/08/2018

45	Debit note to seller		19/08/2018
46	Discount beyond terms		19/08/2018
48	Allowance/charge error		19/08/2018
49	Substitute product		19/08/2018
50	Terms of sale error		19/08/2018
52	Wrong invoice		19/08/2018
53	Duplicate invoice		19/08/2018
54	Weight error		19/08/2018
55	Additional charge not authorized		19/08/2018
56	Incorrect discount		19/08/2018
57	Price change		19/08/2018
58	Variation		19/08/2018
59	Chargeback		19/08/2018
65	Settlement to agent		19/08/2018
66	Cash discount		19/08/2018
7	Payment on account		19/08/2018
70	Wrong monetary amount resulting from incorrect free goods quantity		19/08/2018
72	Temporary special promotion		19/08/2018
73	Difference in tax rate		19/08/2018
74	Quantity discount		19/08/2018
75	Promotion discount		19/08/2018
76	Cancellation deadline passed		19/08/2018

77	Pricing discount		19/08/2018
78	Volume discount		19/08/2018
79	Sundry discount		19/08/2018
8	Returnable container charge included		19/08/2018
9	Invoice error		19/08/2018
AW A	bonus for works ahead of schedule		
CBK	bank charges		
CCR	servizio di corriere		
CIN	insurance		
CLB	labelling		
CPK	packing		
CSP	special packing		
CW B	penalty for works behind schedule		

#### T421 - size system: nationality

nation or agency identifying the size system

Agency name: eBIZ

tabella cod.: T421

File codes list (Generic code): [http://www.ebiz.enea.it/moda-ml/repository/codelist/draft/gc\\_T421.xml](http://www.ebiz.enea.it/moda-ml/repository/codelist/draft/gc_T421.xml)

Code	Description	Adoption note	Date of insertion
DE	Germany		
ES	Spain		
EU	Europe		
FR	France		
IT	Italy		
UK	United Kingdom		
US	USA		
XX	International		



### T422 - size system: market segment

market segment identifying the size system

Agency name: eBIZ

tabella cod.: T422

File codes list (Generic code): [http://www.ebiz.enea.it/moda-ml/repository/codelist/draft/gc\\_T422.xml](http://www.ebiz.enea.it/moda-ml/repository/codelist/draft/gc_T422.xml)

Code	Description	Adoption note	Date of insertion
B	baby		
C	child		
K	kid		
M	man		
U	unisex		
W	woman		

### T423 - size system: base

base of the size system

Agency name: eBIZ

tabella cod.: T423

File codes list (Generic code): [http://www.ebiz.enea.it/moda-ml/repository/codelist/draft/gc\\_T423.xml](http://www.ebiz.enea.it/moda-ml/repository/codelist/draft/gc_T423.xml)

Code	Description	Adoption note	Date of insertion
1	arab numbers		
2	latin numbers		
3	symbols		
4	letters		
H	height		
L	length		
U	unic		
W	weight		

### T44 - additional code type

qualifier of the additional coding of a product

Agency name: eBIZ

tabella cod.: T44

File codes list (Generic code): [http://www.ebiz.enea.it/moda-ml/repository/codelist/draft/gc\\_T44.xml](http://www.ebiz.enea.it/moda-ml/repository/codelist/draft/gc_T44.xml)

Code	Description	Adoption note	Date of insertion
CC	colour card		
CL	sales collection		
CO	company identification code		08/09/2017
DY	dye number		
LT	lot number		
MDI	Made in		08/09/2017
MS	manufacturing state		
PKG	packaging		09/09/2014
PL	product line		
RGB	RGB value		
SE	selvedge code		

#### T46 - quantity variance reason

reason for the difference between the two quantities specified by the context

Agency name: eBIZ

tabella cod.: T46

File codes list (Generic code): [http://www.ebiz.enea.it/moda-ml/repository/codelist/draft/gc\\_T46.xml](http://www.ebiz.enea.it/moda-ml/repository/codelist/draft/gc_T46.xml)

Code	Description	Adoption note	Date of insertion
DAM	damaged on receipt		
DIF	different article		
NAC	not acceptable for quality or conformance		
NRC	not received		

#### T48 - garment part type

code specifying the type of component or part of a garment (sleeve, neck, ...)

Agency name: eBIZ

tabella cod.: T48

File codes list (Generic code): [http://www.ebiz.enea.it/moda-ml/repository/codelist/draft/gc\\_T48.xml](http://www.ebiz.enea.it/moda-ml/repository/codelist/draft/gc_T48.xml)

Code	Description	Adoption note	Date of insertion
BB	bottom back		01/08/2018
BF	bottom fore/front		01/08/2018
CO	collar		01/08/2018
CU	cuff		01/08/2018
DV	fore		
EM	embroidery		01/08/2018
OC	other component		01/08/2018
PO	pocket		01/08/2018
SC	back		
SL	sleeve		01/08/2018
TB	top back		01/08/2018
TF	top fore/front		01/08/2018

## T5 - fabric piece inner packing (wrapping) 2

code specifying the sub-type of inner wrapping/packing used for the fabric piece

Agency name: eBIZ

tabella cod.: T5

File codes list (Generic code): [http://www.ebiz.enea.it/moda-ml/repository/codelist/draft/gc\\_T5.xml](http://www.ebiz.enea.it/moda-ml/repository/codelist/draft/gc_T5.xml)

Code	Description	Adoption note	Date of insertion
A	Open		
B	Folded once, not looped		
C	Folded twice, not looped		
H	Folded once, looped		
I	Folded twice, looped		
J	Without inner object, right side inside		
K	On carton or spooling plank, right side inside		
L	On spool (for pressure sensitive products), right side inside		
M	Without inner object, left side inside		
N	On carton or spooling plank, left side inside		
O	On spool (for pressure sensitive products), left side inside		
P	Without inner object, right side inside (deprecated code)		
Q	On carton, right side inside		

R	On wooden stick, right side inside		
S	Without inner object, left side inside (deprecated code)		
T	On carton, left side inside		
U	On wooden stick, left side inside		

### T6 - fabric piece outer packing

code specifying the type of outer wrapping or packing used for the fabric piece

Agency name: eBIZ

tabella cod.: T6

File codes list (Generic code): [http://www.ebiz.enea.it/moda-ml/repository/codelist/draft/gc\\_T6.xml](http://www.ebiz.enea.it/moda-ml/repository/codelist/draft/gc_T6.xml)

Code	Description	Adoption note	Date of insertion
0	Not wrapped		
1	Totally wrapped		
2	Wrapped, one side open		
3	Wrapped, both sides open		
4	Wrapped, one side open, with show corner		
5	Wrapped in cartons		
6	Double wrapped		

### T61 - duty or tax or fee type

duty or tax or fee type

Agency name: eBIZ

tabella cod.: T61

File codes list (Generic code): [http://www.ebiz.enea.it/moda-ml/repository/codelist/draft/gc\\_T61.xml](http://www.ebiz.enea.it/moda-ml/repository/codelist/draft/gc_T61.xml)

Code	Description	Adoption note	Date of insertion
BOL	stamp duty		01/07/2013
CUD	customs duty		01/07/2013
ENV	environmental tax		01/07/2013
FRE	no tax		01/07/2013
OTH	other tax charges		01/07/2013
VAT	value added tax		01/07/2013

## T62 - duty or tax or fee category

duty or tax or fee category

Agency name: eBIZ

tabella cod.: T62

File codes list (Generic code): [http://www.ebiz.enea.it/moda-ml/repository/codelist/draft/gc\\_T62.xml](http://www.ebiz.enea.it/moda-ml/repository/codelist/draft/gc_T62.xml)

Code	Description	Adoption note	Date of insertion
AA	lower than standard rate		01/07/2013
E	tax not applicable		01/07/2013
H	higher than standard rate		01/07/2013
O	outside scope of tax		01/07/2013
S	standard rate		01/07/2013
Z	zero rate goods		01/07/2013

## T7 - manufacturing status

code of the manufacturing stage used to describe the progress in the production cycle

Agency name: eBIZ

tabella cod.: T7

File codes list (Generic code): [http://www.ebiz.enea.it/moda-ml/repository/codelist/draft/gc\\_T7.xml](http://www.ebiz.enea.it/moda-ml/repository/codelist/draft/gc_T7.xml)

Code	Description	Adoption note	Date of insertion
000	to be launched		
001	launched		01/07/2013
010	knitted		
020	packed		
090	preparing		01/07/2013
095	prepared		01/07/2013
100	warping		
199	warped		
200	weaving		
299	woven		
300	dyeing		
399	dyed		

400	finishing		
499	finished		
500	printing		
599	printed		
600	darning		
640	preparing for printing		01/07/2013
650	prepared for printing		01/07/2013
660	checking		01/07/2013
670	checked		01/07/2013
700	spinning		
799	spun		
800	twisting		
899	twisted		
900	despatch-ready		
950	despatched		
999	other, see note if any		01/07/2013

### T8 - Modes of Transport

way of transport, in general or referred to the specified leg

Agency name: eBIZ

tabella cod.: T8

File codes list (Generic code): [http://www.ebiz.enea.it/moda-ml/repository/codelist/draft/gc\\_T8.xml](http://www.ebiz.enea.it/moda-ml/repository/codelist/draft/gc_T8.xml)

Code	Description	Adoption note	Date of insertion
1	MARITIME TRANSPORT		
10	Courier		01/07/2013
2	RAIL TRANSPORT		
3	ROAD TRANSPORT		
4	AIR TRANSPORT		
5	MAIL		
6	AIR + SHIP TRANSPORT		
8	INLAND WATER TRANSPORT		
9	MODE UNKNOWN		

## **T9 - ISO4217 - Currency**

currency code

Agency name: ISO

tabella cod.: T9

File codes list (Generic code): [http://www.ebiz.enea.it/moda-ml/repository/codelist/draft/gc\\_T9.xml](http://www.ebiz.enea.it/moda-ml/repository/codelist/draft/gc_T9.xml)

Table not printed: there are 205 elements, more than the maximum specified for printing: 99.