



<http://www.ebiz-tcf.eu>

IMPLEMENTATION GUIDE

includes COMPARISON BETWEEN CURRENT and LAST
PREVIOUSLY RELEASED VERSION

TRANSACTION "SPINNING ORDER CHANGE"

Version: v2018-1

Date of release: 18/7/2019

Document code: G055rv

technical Documentation: <http://www.ebiz.enea.it>

XML Schemas repository: <http://www.ebiz.enea.it/moda-ml/repository/schema/v2018-1/default.asp>

Guides repository: <http://www.ebiz.enea.it/moda-ml/repository/guide/v2018-1/default.asp>

Guide filename: G055rv-eBIZ-SpinningOrderChange.pdf

1. BUSINESS DESCRIPTION

1.1 Scope

The present guide has been issued to assist the companies of the Textile-Clothing sector in the implementation of the standard XML document type "SPINNING ORDER CHANGE", providing all the instruction required for its use in the context of e-commerce between Dyeing Subcontractors and their Customers shown in the enclosed diagram

All the rules required for the construction and validation of the document are embedded into the specific XML-Schema, which is detailed in section "Implementation guide".

1.2 Generalities

The Commissioner sends to the Subcontractor a spinning Order Change any time he must modify some conditions of his previous Order (eg. to suspend operations already ordered) or amend errors.

Basic function of the message is to replace an invalid Order with a valid Order, amending:

- suppliable quantities
- dates and places of delivery
- prices

The Order Change can show a number of lines different from the related Purchase Order, when variations/cancellations have occurred so as to create the splitting of an Order Line.

However the sum of the quantities of the lines in the Order Change (confirmed + varied + cancelled) must always not less than the sum of the quantities in the original Order.

When the quantity is change the original line must be splitted and the confimed amount and canceled amount should be explicated through the 'act' flag.

1.3. Possible scenario

Subcontracted spinning of raw material

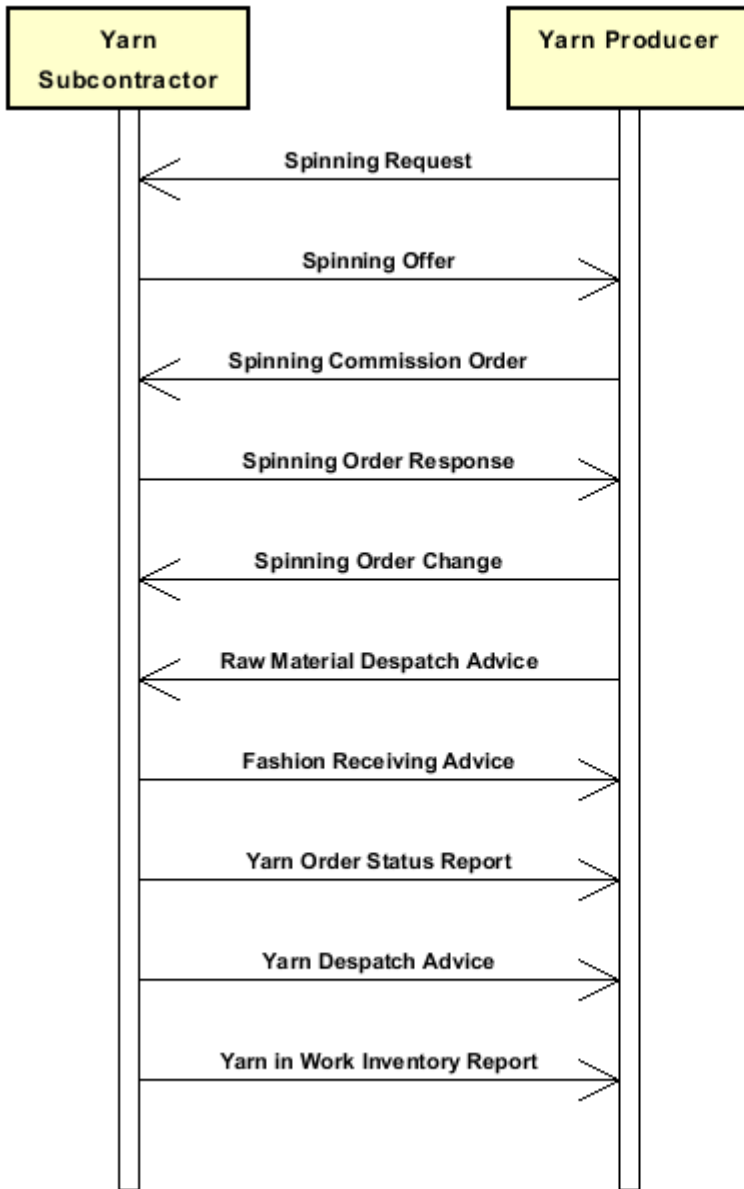

2. IMPLEMENTATION GUIDE

2.1 General structure of XML document

All the business data that can be exchanged through this class of documents are shown in the following "document structure", that provides a simplified vision of the Schema.

In particular:

- the two numbers following each element define its "cardinality" (minimum and maximum number of occurrences); the minimum equal zero indicates that the element is optional, the minimum greater than zero indicates that is mandatory;
- the bold character denotes the complex elements (aggregates of simple elements) that were built for the sake of functionality and re-usability of some complex informations sets. The child elements in each parent element are easily spotted as "indented";
- the symbol "@" denotes an attribute of the preceding element; here "the usage indicator (optional, required, ...)" is shown in square brackets.

Legenda

- N: new element
- U: updated properties
- P: changes in children
- p: is a changed child
- A: changes in attributes
- a: is a new or changed attribute
- *: is a subtype

Structure

RAWSpinOrdChange

@msgfunction [Optional] [Default= OR]

@version [Optional] [Default= 2018-1]

@useProfile [Optional]

```
| RSCXheader 1-1 (P)
| | msgN 1-1
| | - choose -
| | | docID 0-1
| | | @numberingOrg [Optional]
| | | - or -
| | | msgID 0-1
| | | - end choose -
| | | msgDate 1-1
| | | @dateForm [Optional]
| | | season 0-1 (A)
| | | @numberingOrg [Optional] (a)
| | | @codeList [Optional] (a)
| | | @listName [Optional] (a)
| | | @listVersion [Optional] (a)
| | | msgCurrency 0-1
| | | refDoc 1-9 (P)
| | | @docType [Required]
| | | | docID 1-2 (p)
| | | | @numberingOrg [Optional]
| | | | docDate 0-1
| | | | @dateForm [Optional]
| | | | season 0-1 (A)
| | | | @numberingOrg [Optional] (a)
| | | | @codeList [Optional] (a)
| | | | @listName [Optional] (a)
```

- | | | *@listVersion [Optional]* (a)
- | | | itemID 0-1 (U)
- | | | **attachment 0-1** (N)
- | | | *@uid [Optional]*
 - | | | | fileName 0-1 (N)
 - | | | | *@numberingOrg [Optional]*
 - | | | | binaryObject 0-1 (N)
 - | | | | *@format [Optional]* (N)
 - | | | | *@mime [Optional]* (N)
 - | | | | *@encoding [Optional]* (N)
 - | | | | *@characterSet [Optional]* (N)
- | | | **externalReference 0-99** (N)
 - | | | | uri 1-1 (N)
 - | | | | *@isURL [Optional] [Default= true]* (Na)
 - | | | | mimeTypeCode 0-1 (N)
 - | | | | formatCode 0-1 (N)
 - | | | | encodingCode 0-1 (N)
 - | | | | characterSetCode 0-1 (N)
- | | | **buyer 1-1** (AP)
 - | | | | *@logo [Optional]*
 - | | | | *@sender [Optional]* (a*)
 - | | | | | id 1-1 (p)
 - | | | | | *@numberingOrg [Optional]*
 - | | | | | additionalIdentifier 0-9 (N)
 - | | | | | *@numberingOrg [Optional]* (a)
 - | | | | | *@idQualifier [Optional]* (Na)
 - | | | | | legalName 0-1 (U)
 - | | | | | dept 0-1
 - | | | | | subDept 0-1 (N)
 - | | | | | person 0-1
 - | | | | | | *@email [Optional]*
 - | | | | | | *@phone [Optional]*
 - | | | | | | *@fax [Optional]*
 - | | | | | | street 0-1
 - | | | | | | city 0-1
 - | | | | | | subCountry 0-1
 - | | | | | | country 0-1
 - | | | | | | postCode 0-1
- | | | **subContractor 1-1** (AP)
 - | | | | *@sender [Optional]* (a*)
 - | | | | | id 1-1
 - | | | | | | *@numberingOrg [Optional]*
 - | | | | | legalName 0-1 (U)
 - | | | | | dept 0-1
 - | | | | | subDept 0-1 (N)
 - | | | | | person 0-1
 - | | | | | | *@email [Optional]*
 - | | | | | | *@phone [Optional]*
 - | | | | | | *@fax [Optional]*
 - | | | | | | street 0-1
 - | | | | | | city 0-1
 - | | | | | | subCountry 0-1
 - | | | | | | country 0-1
 - | | | | | | postCode 0-1
- | | | **thirdParty 0-5** (AP)
 - | | | | *@VAT [Optional]*
 - | | | | *@role [Required]*
 - | | | | *@sender [Optional]* (a*)
 - | | | | | id 1-1
 - | | | | | | *@numberingOrg [Optional]*
 - | | | | | legalName 0-1 (U)

- | | dept 0-1
- | | subDept 0-1 (N)
- | | person 0-1
- | | @email [Optional]
- | | @phone [Optional]
- | | @fax [Optional]
- | | street 0-1
- | | city 0-1
- | | subCountry 0-1
- | | country 0-1
- | | postCode 0-1
- | | note 0-99
- | | @numberingOrg [Optional]
- | | @codeList [Optional]
- | | @noteLabel [Optional]

| **terms 0-1 (P)**

- | | **payment 0-5**
- | | @finDiscount [Optional]
- | | @finSurcharge [Optional]
- | | - choose -
- | | | payTerm 1-1
- | | | - or -
- | | | payTermText 1-1 (U)
- | | | - end choose -
- | | | payMode 0-1

- | | **insPayment 0-5**
- | | @part [Required]
- | | - choose -
- | | | payTerm 1-1
- | | | - or -
- | | | payTermText 1-1 (U)
- | | | - end choose -
- | | | payMode 0-1

- | | **trade 0-1**
- | | - choose -
- | | | incoTermText 1-1 (U)
- | | | - or -
- | | | incoTerm 1-1
- | | | - end choose -
- | | | location 0-1
- | | | @LRI [Optional]

- | | **transInfo 0-5 (pAP)**
- | | @transReason [Optional]
- | | @progr [Optional] (N)
- | | transMode 1-1
- | | carrier 0-1
- | | deliveryPlace 0-1 (U)
- | | grossWeight 0-1
- | | @um [Required]
- | | netWeight 0-1
- | | @um [Required]
- | | transMeans 0-1
- | | transCondition 0-3
- | | transConditionText 0-1 (U)
- | | despatchPlace 0-1 (N)
- | | despatchDate 0-1 (N)
- | | @dateForm [Optional] (a)
- | | delEffectiveDate 0-1 (p)
- | | @dateForm [Optional]

- | | **allowanceCharge 0-9 (A)**

- | | @um [Optional] (a)
- | | @VAT [Optional]
- | | @minQty [Optional] (a)
- | | @currency [Optional] (a)
- | | @maxQty [Optional] (N)
- | | @isCharge [Optional] (N)
- | | - choose -
- | | | AC_category 1-1
- | | - or -
- | | | AC_categoryText 1-1 (U)
- | | - end choose -
- | | - choose -
- | | | AC_percent 1-1
- | | - or -
- | | | AC_amount 1-1 (A)
- | | | @currency [Optional] (a)
- | | - end choose -
- | | | **dtScheme 0-1** (P)
- | | | @taxType [Required]
- | | | taxCategory 0-1
- | | | taxRate 0-1
- | | | legalRef 0-1 (A)
- | | | @numberingOrg [Optional]
- | | | @codeList [Optional]
- | | | @listName [Optional]
- | | | @listVersion [Optional]
- | | | note 0-99
- | | | @numberingOrg [Optional]
- | | | @codeList [Optional]
- | | | @noteLabel [Optional]

| RSCXbody 1-1

- | | **RSCXitem 1-unbounded** (P)
- | | @act [Required]
- | | lineN 1-1
- | | @VAT [Optional]
- | | **refDoc 1-9** (P)
- | | @docType [Required]
- | | docID 1-2 (p)
- | | @numberingOrg [Optional]
- | | docDate 0-1
- | | @dateForm [Optional]
- | | season 0-1 (A)
- | | @numberingOrg [Optional] (a)
- | | @codeList [Optional] (a)
- | | @listName [Optional] (a)
- | | @listVersion [Optional] (a)
- | | itemID 0-1 (U)
- | | **attachment 0-1** (N)
- | | @uid [Optional]
- | | | fileName 0-1 (N)
- | | | @numberingOrg [Optional] (a)
- | | | binaryObject 0-1 (N)
- | | | @format [Optional] (Na)
- | | | @mime [Optional] (Na)
- | | | @encoding [Optional] (Na)
- | | | @characterSet [Optional] (Na)
- | | | **externalReference 0-99** (N)
- | | | | uri 1-1 (N)
- | | | | @isURL [Optional] [Default= true] (Na)
- | | | | mimeTypeCode 0-1 (N)

```

| | | | | formatCode 0-1 (N)
| | | | | encodingCode 0-1 (N)
| | | | | characterSetCode 0-1 (N)
| | | | | yarnProd 0-1 (P)
| | | | | @CTest [Optional]
| | | | | | yarnCode 1-1 (P)
| | | | | | | @numberingOrg [Optional] [Default= CL]
| | | | | | | | art 1-1 (U)
| | | | | | | | | @numberingOrg [Optional]
| | | | | | | | | @codeList [Optional]
| | | | | | | | | @listName [Optional]
| | | | | | | | | @listVersion [Optional]
| | | | | | | | | color 0-1
| | | | | | | | | | @numberingOrg [Optional]
| | | | | | | | | | @codeList [Optional]
| | | | | | | | | | @listName [Optional]
| | | | | | | | | | @listVersion [Optional]
| | | | | | | | | added 0-9
| | | | | | | | | | @numberingOrg [Optional]
| | | | | | | | | | @addType [Optional]
| | | | | | | | | description 0-unbounded (AU)
| | | | | | | | | | @ln [Optional] (N)
| | | | | | | | | yarnCompos 0-1
| | | | | | | | | | percCompos 1-9
| | | | | | | | | | | @fibre [Required]
| | | | | | | | | | yarnSpecs 0-99 (p)
| | | | | | | | | | - choose -
| | | | | | | | | | | yarnCharText 1-1 (U)
| | | | | | | | | | | - or -
| | | | | | | | | | | | yarnChar 1-1
| | | | | | | | | | | | - end choose -
| | | | | | | | | | | | | experimValue 0-1
| | | | | | | | | | | | | | @um [Optional]
| | | | | | | | | | | | | | @method [Optional]
| | | | | | | | | | | | | | @application [Optional]
| | | | | | | | | | | | | | @idCO [Optional]
| | | | | | | | | | | | | | specValue 0-1
| | | | | | | | | | | | | | | @um [Optional]
| | | | | | | | | | | | | | | @source [Optional]
| | | | | | | | | | | | | | | @method [Optional]
| | | | | | | | | | | | | | | @application [Optional]
| | | | | | | | | | | | | | | @CV [Optional]
| | | | | | | | | | | | | | - choose -
| | | | | | | | | | | | | | | tolerance 0-2
| | | | | | | | | | | | | | | | @um [Required]
| | | | | | | | | | | | | | | - or -
| | | | | | | | | | | | | | | | pcTolerance 0-2
| | | | | | | | | | | | | | | | | @um [Optional]
| | | | | | | | | | | | | | | | - end choose -
| | | | | | | | | | | | | | | | colorCardItem 0-1 (P)
| | | | | | | | | | | | | | | | color 1-2
| | | | | | | | | | | | | | | | | @numberingOrg [Optional]
| | | | | | | | | | | | | | | | | @codeList [Optional]
| | | | | | | | | | | | | | | | | @listName [Optional]
| | | | | | | | | | | | | | | | | @listVersion [Optional]
| | | | | | | | | | | | | | | | | CIELab 0-unbounded
| | | | | | | | | | | | | | | | | | @illuminant [Optional]
| | | | | | | | | | | | | | | | | | @standardObserver [Optional]
| | | | | | | | | | | | | | | | | | | L 1-1
| | | | | | | | | | | | | | | | | | | a 1-1
| | | | | | | | | | | | | | | | | | | b 1-1

```



```

| | | | refDoc 0-1 (P)
| | | | @docType [Required]
| | | | docID 1-2 (p)
| | | | @numberingOrg [Optional]
| | | | docDate 0-1
| | | | @dateForm [Optional]
| | | | season 0-1 (A)
| | | | @numberingOrg [Optional] (a)
| | | | @codeList [Optional] (a)
| | | | @listName [Optional] (a)
| | | | @listVersion [Optional] (a)
| | | | itemID 0-1 (U)
| | | | attachment 0-1 (N)
| | | | @uid [Optional]
| | | | | fileName 0-1 (N)
| | | | | @numberingOrg [Optional] (a)
| | | | | binaryObject 0-1 (N)
| | | | | @format [Optional] (Na)
| | | | | @mime [Optional] (Na)
| | | | | @encoding [Optional] (Na)
| | | | | @characterSet [Optional] (Na)
| | | | | externalReference 0-99 (N)
| | | | | | uri 1-1 (N)
| | | | | | @isURL [Optional] [Default= true] (Na)
| | | | | | mimeTypeCode 0-1 (N)
| | | | | | formatCode 0-1 (N)
| | | | | | encodingCode 0-1 (N)
| | | | | | characterSetCode 0-1 (N)
| | | | description 0-unbounded (AU)
| | | | @In [Optional] (N)
| | | | lotN 0-1
| | | | @numberingOrg [Optional]
| | | | dyeN 0-1
| | | | @numberingOrg [Optional]
| | | | yarnPack 0-1
| | | | | yarnReel 1-1
| | | | | @reelType [Required]
| | | | | @reelMat [Optional]
| | | | | | yarnReelD 0-1
| | | | | | @um [Required]
| | | | | | yarnReelH 0-1
| | | | | | @um [Required]
| | | | | | yarnConeAngle 0-1
| | | | | | yarnReelQty 0-2
| | | | | | @um [Required]
| | | | | | label 0-1
| | | | | | labelWrit 0-1
| | | | | yarnInWrap 0-1
| | | | | | yarnReelWrap 1-1
| | | | | | label 0-1
| | | | | | labelWrit 0-1
| | | | - choose -
| | | | | yarnOutWrapText 0-1 (U)
| | | | - or -
| | | | | yarnOutWrap 0-1
| | | | - end choose -
| | | | note 0-99
| | | | @numberingOrg [Optional]
| | | | @codeList [Optional]
| | | | @noteLabel [Optional]
| | | | qty 0-2

```

@um [Required]
 price 0-1 (AU)
 @um [Optional]
 @priceQualifier [Optional] [Default= NET]
 @currency [Optional] (a)
 deliveryDate 0-1
 @dateForm [Optional]
thirdParty 0-3 (AP)
 @VAT [Optional]
 @role [Required]
 @sender [Optional] (a*)
 | id 1-1
 | @numberingOrg [Optional]
 | legalName 0-1 (U)
 | dept 0-1
 | subDept 0-1 (N)
 | person 0-1
 | @email [Optional]
 | @phone [Optional]
 | @fax [Optional]
 | street 0-1
 | city 0-1
 | subCountry 0-1
 | country 0-1
 | postCode 0-1
rawComponent 0-9 (P)
 @CQQ [Optional]
 | pcQty 0-1
 | @um [Optional]
rawCode 1-1 (P)
 @numberingOrg [Optional]
 | art 1-1 (U)
 | @numberingOrg [Optional]
 | @codeList [Optional]
 | @listName [Optional]
 | @listVersion [Optional]
 | color 0-1
 | @numberingOrg [Optional]
 | @codeList [Optional]
 | @listName [Optional]
 | @listVersion [Optional]
 | added 0-9
 | @numberingOrg [Optional]
 | @addType [Optional]
 | description 0-unbounded (AU)
 | @ln [Optional] (N)
 lotN 0-1
 @numberingOrg [Optional]
 dyeN 0-1
 @numberingOrg [Optional]
 qty 1-2
 @um [Required]
refDoc 0-9 (P)
 @docType [Required]
 | docID 1-2
 | @numberingOrg [Optional]
 | docDate 0-1
 | @dateForm [Optional]
 | season 0-1 (A)
 | @numberingOrg [Optional] (a)
 | @codeList [Optional] (a)

```

| | | | @listName [Optional] (a)
| | | | @listVersion [Optional] (a)
| | | | itemID 0-1 (U)
| | | | attachment 0-1 (N)
| | | | | @uid [Optional]
| | | | | | fileName 0-1 (N)
| | | | | | @numberingOrg [Optional] (a)
| | | | | | binaryObject 0-1 (N)
| | | | | | @format [Optional] (Na)
| | | | | | @mime [Optional] (Na)
| | | | | | @encoding [Optional] (Na)
| | | | | | @characterSet [Optional] (Na)
| | | | | | externalReference 0-99 (N)
| | | | | | | uri 1-1 (N)
| | | | | | | | @isURL [Optional] [Default= true] (Na)
| | | | | | | | mimeTypeCode 0-1 (N)
| | | | | | | | formatCode 0-1 (N)
| | | | | | | | encodingCode 0-1 (N)
| | | | | | | | characterSetCode 0-1 (N)
| | | | location 0-1
| | | | | @LRI [Optional]
| | | | note 0-99
| | | | | @numberingOrg [Optional]
| | | | | @codeList [Optional]
| | | | | @noteLabel [Optional]
| | | | rawMnfrOperation 0-9 (P)
| | | | - choose -
| | | | | rawJob 1-1
| | | | - or -
| | | | | jobName 1-1
| | | | - end choose -
| | | | refDoc 0-9 (P)
| | | | | @docType [Required]
| | | | | | docID 1-2 (p)
| | | | | | @numberingOrg [Optional]
| | | | | | docDate 0-1
| | | | | | @dateForm [Optional]
| | | | | | season 0-1 (A)
| | | | | | @numberingOrg [Optional] (a)
| | | | | | @codeList [Optional] (a)
| | | | | | @listName [Optional] (a)
| | | | | | @listVersion [Optional] (a)
| | | | | | itemID 0-1 (U)
| | | | | | attachment 0-1 (N)
| | | | | | | @uid [Optional]
| | | | | | | | fileName 0-1 (N)
| | | | | | | | @numberingOrg [Optional] (a)
| | | | | | | | binaryObject 0-1 (N)
| | | | | | | | @format [Optional] (Na)
| | | | | | | | @mime [Optional] (Na)
| | | | | | | | @encoding [Optional] (Na)
| | | | | | | | @characterSet [Optional] (Na)
| | | | | | | | externalReference 0-99 (N)
| | | | | | | | | uri 1-1 (N)
| | | | | | | | | | @isURL [Optional] [Default= true] (Na)
| | | | | | | | | | mimeTypeCode 0-1 (N)
| | | | | | | | | | formatCode 0-1 (N)
| | | | | | | | | | encodingCode 0-1 (N)
| | | | | | | | | | characterSetCode 0-1 (N)
| | | | note 0-99
| | | | | @numberingOrg [Optional]

```

```

| | | | @codeList [Optional]
| | | | @noteLabel [Optional]
| | | yarnMnfrOperation 0-9 (P)
| | | - choose -
| | | | jobName 1-1
| | | - or -
| | | | yarnJob 1-1
| | | - end choose -
| | | | yarnJobTech 0-1
| | | | refDoc 0-9 (P)
| | | | @docType [Required]
| | | | | docID 1-2 (p)
| | | | | @numberingOrg [Optional]
| | | | | docDate 0-1
| | | | | @dateForm [Optional]
| | | | | season 0-1 (A)
| | | | | @numberingOrg [Optional] (a)
| | | | | @codeList [Optional] (a)
| | | | | @listName [Optional] (a)
| | | | | @listVersion [Optional] (a)
| | | | | itemID 0-1 (U)
| | | | | attachment 0-1 (N)
| | | | | @uid [Optional]
| | | | | | fileName 0-1 (N)
| | | | | | @numberingOrg [Optional] (a)
| | | | | | binaryObject 0-1 (N)
| | | | | | @format [Optional] (Na)
| | | | | | @mime [Optional] (Na)
| | | | | | @encoding [Optional] (Na)
| | | | | | @characterSet [Optional] (Na)
| | | | | | externalReference 0-99 (N)
| | | | | | | uri 1-1 (N)
| | | | | | | @isURL [Optional] [Default= true] (Na)
| | | | | | | mimeTypeCode 0-1 (N)
| | | | | | | formatCode 0-1 (N)
| | | | | | | encodingCode 0-1 (N)
| | | | | | | characterSetCode 0-1 (N)
| | | | yarnMachine 0-1
| | | | yarnMachineSpecs 0-9
| | | | | yarnMachineParam 1-1
| | | | | specValue 0-1
| | | | | @um [Optional]
| | | | | @source [Optional]
| | | | | @method [Optional]
| | | | | @application [Optional]
| | | | | @CV [Optional]
| | | | - choose -
| | | | | tolerance 0-2
| | | | | @um [Required]
| | | | - or -
| | | | | pcTolerance 0-2
| | | | | @um [Optional]
| | | | - end choose -
| | | | | note 0-99
| | | | | @numberingOrg [Optional]
| | | | | @codeList [Optional]
| | | | | @noteLabel [Optional]
| | | | dtScheme 0-1 (P)
| | | | @taxType [Required]
| | | | | taxCategory 0-1
| | | | | taxRate 0-1

```

			legalRef 0-1 (A)
			@numberingOrg [Optional]
			@codeList [Optional]
			@listName [Optional]
			@listVersion [Optional]
			note 0-99
			@numberingOrg [Optional]
			@codeList [Optional]
			@noteLabel [Optional]
			note 0-99
			@numberingOrg [Optional]
			@codeList [Optional]
			@noteLabel [Optional]

2.2 Detailed description of document elements

Following tables show all elements (complex and simple) used in this document. Description includes: 1) element's information: xml tag, name, brief description, data type and syntax constraints; 2) information about use of the element in a particular position in the document: xpath and possible associated notes.

2.2.1 Complex elements (Aggregate Business Information Entities)

Complex elements are those elements whose content is composed of other elements (childs).Complex elements are alphabetically ordered.

allowanceCharge	Allowances and Charges related to an Order or a contract (XPath RAWSpinOrdChange/terms/allowanceCharge) 0-9 (A)
attachment	an attached document. An attachment can refer to an external document or be included with the document being exchanged (XPath RAWSpinOrdChange/RSCXbody/RSCXitem/rawComponent/refDoc/attachment) 0-1 (N) (XPath RAWSpinOrdChange/RSCXbody/RSCXitem/rawMnfrOperation/refDoc/attachment) 0-1 (N) (XPath RAWSpinOrdChange/RSCXheader/refDoc/attachment) 0-1 (N) (XPath RAWSpinOrdChange/RSCXbody/RSCXitem/yarnMnfrOperation/refDoc/attachment) 0-1 (N) (XPath RAWSpinOrdChange/RSCXbody/RSCXitem/refDoc/attachment) 0-1 (N) (XPath RAWSpinOrdChange/RSCXbody/RSCXitem/yarnProd/colorCardItem/refDoc/attachment) 0-1 (N)
buyer	details of the Buyer (party that buys the good or service that is object of the current collaborative process) - base type: Nad, (XPath RAWSpinOrdChange/RSCXheader/buyer) 1-1 (AP)
CIELab	color point in the CIELab color space (XPath RAWSpinOrdChange/RSCXbody/RSCXitem/yarnProd/colorCardItem/CIELab) 0-unbounded
colorCardItem	item of the color card (XPath RAWSpinOrdChange/RSCXbody/RSCXitem/yarnProd/colorCardItem) 0-1 (P)
dtScheme	set of data usable to declare the duty or tax applied (XPath RAWSpinOrdChange/RSCXbody/RSCXitem/dtScheme) 0-1 (P) - note: <i>recommended alternative to the attribute @VAT</i> (XPath RAWSpinOrdChange/terms/allowanceCharge/dtScheme) 0-1 (P)
externalReference	details about an external object, such as a document stored at a remote location (XPath RAWSpinOrdChange/RSCXbody/RSCXitem/yarnProd/colorCardItem/refDoc/attachment/externalReference) 0-99 (N) (XPath RAWSpinOrdChange/RSCXbody/RSCXitem/refDoc/attachment/externalReference) 0-99 (N) (XPath RAWSpinOrdChange/RSCXheader/refDoc/attachment/externalReference) 0-99 (N) (XPath RAWSpinOrdChange/RSCXbody/RSCXitem/rawComponent/refDoc/attachment/externalReference) 0-99 (N) (XPath RAWSpinOrdChange/RSCXbody/RSCXitem/rawMnfrOperation/refDoc/attachment/externalReference) 0-99 (N) (XPath RAWSpinOrdChange/RSCXbody/RSCXitem/yarnMnfrOperation/refDoc/attachment/externalReference) 0-99 (N)

insPayment	<p>payment details for payment by installments (XPath RAWSpinOrdChange/terms/insPayment) 0-5 - note: <i>excluded the case of offers, this set of data is alternative to payment set and must be iterated for each payment installment</i></p>
payment	<p>payment details for payment all in one (XPath RAWSpinOrdChange/terms/payment) 0-5 - note: <i>excluded the case of offers, this set of data is alternative to insPayment, it can be iterated to specify alternative terms of payment (e.g.: 60 days or 30 days with 3% discount)</i></p>
rawCode	<p>full codification of a raw material (XPath RAWSpinOrdChange/RSCXbody/RSCXitem/rawComponent/rawCode) 1-1 (P)</p>
rawComponent	<p>identification details of a raw material used in a sub-contracted manufacturing operation (XPath RAWSpinOrdChange/RSCXbody/RSCXitem/rawComponent) 0-9 (P)</p>
rawMnfrOperation	<p>details of a manufacturing operation on raw material used for manufacturing a yarn product (XPath RAWSpinOrdChange/RSCXbody/RSCXitem/rawMnfrOperation) 0-9 (P)</p>
refDoc	<p>identification of a document and of an item thereof, to which the message makes reference (XPath RAWSpinOrdChange/RSCXbody/RSCXitem/refDoc) 1-9 (P) - note: <i>At least one occurrence should contain a reference to the order it responds to (for example docType=ORD or OCH or BOR)</i> (XPath RAWSpinOrdChange/RSCXbody/RSCXitem/rawMnfrOperation/refDoc) 0-9 (P) (XPath RAWSpinOrdChange/RSCXbody/RSCXitem/rawComponent/refDoc) 0-9 (P) (XPath RAWSpinOrdChange/RSCXheader/refDoc) 1-9 (P) - note: <i>At least one occurrence should contain a reference to the order it responds to (for example docType=ORD or OCH or BOR)</i> (XPath RAWSpinOrdChange/RSCXbody/RSCXitem/yarnProd/colorCardItem/refDoc) 0-1 (P) - note: <i>here the CxF3 file can be referenced</i> (XPath RAWSpinOrdChange/RSCXbody/RSCXitem/yarnMnfrOperation/refDoc) 0-9 (P) - note: <i>here a Process Sheet transmitted to the Subcontractor can be referenced</i></p>
RSCXbody	<p>body of the documents SPINNING ORDER RESPONSE and CHANGE (XPath RAWSpinOrdChange/RSCXbody) 1-1</p>
RSCXheader	<p>header of the documents SPINNING ORDER RESPONSE and CHANGE (XPath RAWSpinOrdChange/RSCXheader) 1-1 (P)</p>
RSCXitem	<p>line of the documents SPINNING ORDER RESPONSE and CHANGE (XPath RAWSpinOrdChange/RSCXbody/RSCXitem) 1-unbounded (P)</p>
subContractor	<p>details of the Sub-contractor - base type: Nad, (XPath RAWSpinOrdChange/RSCXheader/subContractor) 1-1 (AP)</p>
terms	<p>details of the commercial obligations for payment and delivery (XPath RAWSpinOrdChange/terms) 0-1 (P)</p>
thirdParty	<p>details of the Third Party, different from Sender and Receiver of the document - base type: Nad, (XPath RAWSpinOrdChange/RSCXheader/thirdParty) 0-5 (AP) (XPath RAWSpinOrdChange/RSCXbody/RSCXitem/thirdParty) 0-3 (AP)</p>
trade	<p>general terms of trade for the specified supply</p>

	(XPath RAWSpinOrdChange/terms/trade) 0-1
transInfo	details of transport: mode, carrier and delivery place (XPath RAWSpinOrdChange/terms/transInfo) 0-5 (pAP)
yarnCode	full codification of a yarn product (XPath RAWSpinOrdChange/RSCXbody/RSCXitem/yarnProd/yarnCode) 1-1 (P) - note: <i>also intermediate products must be virtually codified</i>
yarnCompos	fibrous composition of a yarn product (XPath RAWSpinOrdChange/RSCXbody/RSCXitem/yarnProd/yarnCompos) 0-1
yarnInWrap	details specifying the inner wrapping of a yarn product (XPath RAWSpinOrdChange/RSCXbody/RSCXitem/yarnProd/yarnPack/yarnInWrap) 0-1
yarnMachineSpecs	technical specifications of a machine used in an operation of a work cycle for yarn (type and settings) (XPath RAWSpinOrdChange/RSCXbody/RSCXitem/yarnMnfrOperation/yarnMachineSpecs) 0-9
yarnMnfrOperation	details of a manufacturing operation used for manufacturing a yarn product (XPath RAWSpinOrdChange/RSCXbody/RSCXitem/yarnMnfrOperation) 0-9 (P)
yarnPack	details of type of presentation used for the yarn (XPath RAWSpinOrdChange/RSCXbody/RSCXitem/yarnProd/yarnPack) 0-1
yarnProd	manufacturing specifications of the product to be obtained from an operation of the sub-contracted production of a yarn (XPath RAWSpinOrdChange/RSCXbody/RSCXitem/yarnProd) 0-1 (P)
yarnReel	details of the packaging of a yarn product (bobbin and reel,..) (XPath RAWSpinOrdChange/RSCXbody/RSCXitem/yarnProd/yarnPack/yarnReel) 1-1
yarnSpecs	technical properties of a yarn product linked to an operation of the sub-contracted production of yarn or to the purchase of yarn (XPath RAWSpinOrdChange/RSCXbody/RSCXitem/yarnProd/yarnSpecs) 0-99 (p) - note: <i>here are the specifications referred to the article identified with</i>

2.2.2 Simple elements (Basic Business Information Entities)

Simple elements are those elements whose content is characterized by a data type plus a domain of possible values. Simple elements are alphabetically ordered.

a	"a" dimension of the CIE Lab color system - base type: decimal, (XPath RAWSpinOrdChange/RSCXbody/RSCXitem/yarnProd/colorCardItem/CIE Lab/a) 1-1
AC_amount	amount of an Allowance or Charge - base type: decimal, fraction digits: 2, (XPath RAWSpinOrdChange/terms/allowanceCharge/AC_amount) 1-1 (A)
AC_category	coded specification of an Allowance or Charge - base type: string, cod. table: T41 http://www.ebiz.enea.it/moda-ml/repository/codelist/v2018-1/gc_T41.xml (XPath RAWSpinOrdChange/terms/allowanceCharge/AC_category) 1-1
AC_categoryText	free text description of an Allowance or Charge - base type: string, max length: 250, (XPath RAWSpinOrdChange/terms/allowanceCharge/AC_categoryText) 1-1 (U)

AC_percent	amount of an Allowance or Charge as a percentage (always non negative value) - base type: decimal, max inclusive: 100, fraction digits: 2, (XPath RAWSpinOrdChange/terms/allowanceCharge/AC_percent) 1-1
@act	status that the current line assigns to the line addressed in the reference document; if it is already canceled it maintains the status. - base type: string, cod. table: NT5 http://www.ebiz.enea.it/moda-ml/repository/codelist/v2018-1/gc_NT5.xml (XPath RAWSpinOrdChange/RSCXbody/RSCXitem/@act) [Required]
added	additional code of the product (complementing the formers) - base type: string, max length: 80, (XPath RAWSpinOrdChange/RSCXbody/RSCXitem/yarnProd/yarnCode/added) 0-9 - note: here an additional codification (see table T44) can be specified (XPath RAWSpinOrdChange/RSCXbody/RSCXitem/rawComponent/rawCode/added) 0-9
additionalIdentifier	additional identification code of a Party, for example customs registries or others - base type: string, max length: 15, (XPath RAWSpinOrdChange/RSCXheader/buyer/additionalIdentifier) 0-9 (N) - note: identifiers for example for exports, such as MID (Manufacturer Identification Code), EORI (E.O.R.I. - Economic Operator Registration and Identification)
@addType	qualifier of the additional coding of a product - base type: string, cod. table: T44 http://www.ebiz.enea.it/moda-ml/repository/codelist/v2018-1/gc_T44.xml (XPath RAWSpinOrdChange/RSCXbody/RSCXitem/rawComponent/rawCode/added/@addType) [Optional] - nota: addType allows the clarification of the meaning of the added element content; it is strongly suggested to use it always. (XPath RAWSpinOrdChange/RSCXbody/RSCXitem/yarnProd/yarnCode/added/@addType) [Optional] - nota: addType allows the clarification of the meaning of the added element content; it is strongly suggested to use it always.
@application	force or similar condition (e.g. no. of revolutions) applied in a test as specified within the standard - base type: string, max length: 15, (XPath RAWSpinOrdChange/RSCXbody/RSCXitem/yarnMnfrOperation/yarnMachineSpecs/specValue/@application) [Optional] (XPath RAWSpinOrdChange/RSCXbody/RSCXitem/yarnProd/yarnSpecs/experimValue/@application) [Optional] (XPath RAWSpinOrdChange/RSCXbody/RSCXitem/yarnProd/yarnSpecs/specValue/@application) [Optional]
art	article number of the product - base type: string, max length: 80, (XPath RAWSpinOrdChange/RSCXbody/RSCXitem/yarnProd/yarnCode/art) 1-1 (U) (XPath RAWSpinOrdChange/RSCXbody/RSCXitem/rawComponent/rawCode/art) 1-1 (U)
b	"b" dimension of the CIELab color system - base type: decimal, (XPath RAWSpinOrdChange/RSCXbody/RSCXitem/yarnProd/colorCardItem/CIELab/b) 1-1
binaryObject	a binary large object containing an attached document, Coding 'base64Binary' is recommended. - base type: base64Binary,

	<p>(XPath RAWSpinOrdChange/RSCXbody/RSCXitem/rawMnfrOperation/refDoc/attachment/binaryObject) 0-1 (N)</p> <p>(XPath RAWSpinOrdChange/RSCXbody/RSCXitem/yarnMnfrOperation/refDoc/attachment/binaryObject) 0-1 (N)</p> <p>(XPath RAWSpinOrdChange/RSCXbody/RSCXitem/refDoc/attachment/binaryObject) 0-1 (N)</p> <p>(XPath RAWSpinOrdChange/RSCXbody/RSCXitem/yarnProd/colorCardItem/refDoc/attachment/binaryObject) 0-1 (N)</p> <p>(XPath RAWSpinOrdChange/RSCXheader/refDoc/attachment/binaryObject) 0-1 (N)</p> <p>(XPath RAWSpinOrdChange/RSCXbody/RSCXitem/rawComponent/refDoc/attachment/binaryObject) 0-1 (N)</p>
carrier	<p>identification of the transport carrier</p> <p>- base type: string, max length: 40,</p> <p>(XPath RAWSpinOrdChange/terms/transInfo/carrier) 0-1</p>
@characterSet	<p>the character set of the binary object (examples UTF-8, UTF-16, Windows-1252, ISO-8859-7,..)</p> <p>- base type: normalizedString,</p> <p>(XPath RAWSpinOrdChange/RSCXbody/RSCXitem/rawComponent/refDoc/attachment/binaryObject/@characterSet) [Optional] (Na)</p> <p>(XPath RAWSpinOrdChange/RSCXheader/refDoc/attachment/binaryObject/@characterSet) [Optional] (N)</p> <p>(XPath RAWSpinOrdChange/RSCXbody/RSCXitem/refDoc/attachment/binaryObject/@characterSet) [Optional] (Na)</p> <p>(XPath RAWSpinOrdChange/RSCXbody/RSCXitem/rawMnfrOperation/refDoc/attachment/binaryObject/@characterSet) [Optional] (Na)</p> <p>(XPath RAWSpinOrdChange/RSCXbody/RSCXitem/yarnMnfrOperation/refDoc/attachment/binaryObject/@characterSet) [Optional] (Na)</p> <p>(XPath RAWSpinOrdChange/RSCXbody/RSCXitem/yarnProd/colorCardItem/refDoc/attachment/binaryObject/@characterSet) [Optional] (Na)</p>
characterSetCode	<p>the character set of an external document (examples UTF-8, UTF-16, Windows-1252, ISO-8859-7,..)</p> <p>- base type: normalizedString,</p> <p>(XPath RAWSpinOrdChange/RSCXbody/RSCXitem/refDoc/attachment/externalReference/characterSetCode) 0-1 (N)</p> <p>(XPath RAWSpinOrdChange/RSCXbody/RSCXitem/yarnProd/colorCardItem/refDoc/attachment/externalReference/characterSetCode) 0-1 (N)</p> <p>(XPath RAWSpinOrdChange/RSCXbody/RSCXitem/rawComponent/refDoc/attachment/externalReference/characterSetCode) 0-1 (N)</p> <p>(XPath RAWSpinOrdChange/RSCXbody/RSCXitem/yarnMnfrOperation/refDoc/attachment/externalReference/characterSetCode) 0-1 (N)</p> <p>(XPath RAWSpinOrdChange/RSCXbody/RSCXitem/rawMnfrOperation/refDoc/attachment/externalReference/characterSetCode) 0-1 (N)</p> <p>(XPath RAWSpinOrdChange/RSCXheader/refDoc/attachment/externalReference/characterSetCode) 0-1 (N)</p>
city	<p>name of the city (town, village)</p> <p>- base type: string, max length: 40,</p> <p>(XPath RAWSpinOrdChange/RSCXheader/buyer/city) 0-1</p> <p>(XPath RAWSpinOrdChange/RSCXbody/RSCXitem/thirdParty/city) 0-1</p> <p>(XPath RAWSpinOrdChange/RSCXheader/subContractor/city) 0-1</p> <p>(XPath RAWSpinOrdChange/RSCXheader/thirdParty/city) 0-1</p>
@codeList	<p>it specifies the URL where the list of codes used to make an instance of the element can be found</p> <p>- base type: string, max length: 255,</p>

(XPath RAWSpinOrdChange/RSCXbody/RSCXitem/rawMnfrOperation/refDoc/season/@codeList) [Optional] (a)
- nota: *this attribute should be used either single or coupled with "listName" and "listVersion"*

(XPath RAWSpinOrdChange/RSCXbody/RSCXitem/yarnProd/colorCardItem/color/@codeList) [Optional]
- nota: *this attribute should be used either single or coupled with "listName" and "listVersion"*

(XPath RAWSpinOrdChange/RSCXheader/refDoc/season/@codeList) [Optional] (a)
- nota: *this attribute should be used either single or coupled with "listName" and "listVersion"*

(XPath RAWSpinOrdChange/RSCXbody/RSCXitem/rawComponent/rawCode/art/@codeList) [Optional]
- nota: *at least one out of this attribute and "numberingOrg" should be set*

(XPath RAWSpinOrdChange/RSCXbody/RSCXitem/note/@codeList) [Optional]
- nota: *must be used to provide (URL) the list of codes used in "noteLabel"*

(XPath RAWSpinOrdChange/terms/allowanceCharge/dtScheme/legalRef/@codeList) [Optional]
(XPath RAWSpinOrdChange/RSCXbody/RSCXitem/rawComponent/refDoc/season/@codeList) [Optional] (a)
- nota: *this attribute should be used either single or coupled with "listName" and "listVersion"*

(XPath RAWSpinOrdChange/RSCXheader/season/@codeList) [Optional] (a)
- nota: *this attribute should be used either single or coupled with "listName" and "listVersion"*

(XPath RAWSpinOrdChange/terms/allowanceCharge/dtScheme/note/@codeList) [Optional]
- nota: *must be used to provide (URL) the list of codes used in "noteLabel"*

(XPath RAWSpinOrdChange/RSCXbody/RSCXitem/refDoc/season/@codeList) [Optional] (a)
- nota: *this attribute should be used either single or coupled with "listName" and "listVersion"*

(XPath RAWSpinOrdChange/RSCXbody/RSCXitem/rawComponent/rawCode/color/@codeList) [Optional]
- nota: *this attribute should be used either single or coupled with "listName" and "listVersion"*

(XPath RAWSpinOrdChange/RSCXbody/RSCXitem/yarnProd/colorCardItem/refDoc/season/@codeList) [Optional] (a)
- nota: *this attribute should be used either single or coupled with "listName" and "listVersion"*

(XPath RAWSpinOrdChange/RSCXbody/RSCXitem/rawComponent/note/@codeList) [Optional]
- nota: *must be used to provide (URL) the list of codes used in "noteLabel"*

(XPath RAWSpinOrdChange/RSCXheader/note/@codeList) [Optional]
- nota: *must be used to provide (URL) the list of codes used in "noteLabel"*

(XPath RAWSpinOrdChange/RSCXbody/RSCXitem/rawMnfrOperation/note/@codeList) [Optional]
- nota: *must be used to provide (URL) the list of codes used in "noteLabel"*

(XPath RAWSpinOrdChange/RSCXbody/RSCXitem/dtScheme/legalRef/@codeList) [Optional]
(XPath RAWSpinOrdChange/RSCXbody/RSCXitem/yarnProd/yarnCode/color/@codeList) [Optional]
- nota: *this attribute should be used either single or coupled with "listName" and "listVersion"*

(XPath RAWSpinOrdChange/RSCXbody/RSCXitem/yarnMnfrOperation/note/@codeList) [Optional]
- nota: *must be used to provide (URL) the list of codes used in "noteLabel"*

(XPath RAWSpinOrdChange/RSCXbody/RSCXitem/yarnMnfrOperation/refDoc/season/@codeList) [Optional] (a)
- nota: *this attribute should be used either single or coupled with "listName" and "listVersion"*

	<p>(XPath RAWSpinOrdChange/RSCXbody/RSCXitem/yarnProd/note/@codeList) [Optional]</p> <p>- nota: <i>must be used to provide (URL) the list of codes used in "noteLabel"</i> (XPath RAWSpinOrdChange/RSCXbody/RSCXitem/dtScheme/note/@codeList) [Optional]</p> <p>- nota: <i>must be used to provide (URL) the list of codes used in "noteLabel"</i> (XPath RAWSpinOrdChange/RSCXbody/RSCXitem/yarnProd/yarnCode/art/@codeList) [Optional]</p> <p>- nota: <i>at least one out of this attribute and "numberingOrg" should be set</i></p>
color	<p>colour number of the product, when not included in the model or fabric code</p> <p>- base type: string, max length: 15,</p> <p>(XPath RAWSpinOrdChange/RSCXbody/RSCXitem/rawComponent/rawCode/color) 0-1</p> <p>(XPath RAWSpinOrdChange/RSCXbody/RSCXitem/yarnProd/colorCardItem/color) 1-2</p> <p>- note: <i>multiple color values allowed if they differ for at least one of the numberingOrg and listName attributes</i></p> <p>(XPath RAWSpinOrdChange/RSCXbody/RSCXitem/yarnProd/yarnCode/color) 0-1</p>
country	<p>code of the nation</p> <p>- base type: string, cod. table: T10</p> <p>http://www.ebiz.enea.it/moda-ml/repository/codelist/v2018-1/gc_T10.xml</p> <p>(XPath RAWSpinOrdChange/RSCXheader/thirdParty/country) 0-1</p> <p>(XPath RAWSpinOrdChange/RSCXheader/subContractor/country) 0-1</p> <p>(XPath RAWSpinOrdChange/RSCXbody/RSCXitem/thirdParty/country) 0-1</p> <p>(XPath RAWSpinOrdChange/RSCXheader/buyer/country) 0-1</p>
@CQQ	<p>specifies if the committed quantity can or can not include the loss in weight</p> <p>- base type: string, cod. table: NT37</p> <p>http://www.ebiz.enea.it/moda-ml/repository/codelist/v2018-1/gc_NT37.xml</p> <p>(XPath RAWSpinOrdChange/RSCXbody/RSCXitem/rawComponent/@CQQ) [Optional]</p>
@CTest	<p>indicates the need to execute a colour test before the operation</p> <p>- base type: string, cod. table: NT38</p> <p>http://www.ebiz.enea.it/moda-ml/repository/codelist/v2018-1/gc_NT38.xml</p> <p>(XPath RAWSpinOrdChange/RSCXbody/RSCXitem/yarnProd/@CTest) [Optional]</p>
@currency	<p>currency in which a specified monetary data is expressed</p> <p>- base type: string, cod. table: T9</p> <p>http://www.ebiz.enea.it/moda-ml/repository/codelist/v2018-1/gc_T9.xml</p> <p>(XPath RAWSpinOrdChange/terms/allowanceCharge/@currency) [Optional] (a)</p> <p>(XPath RAWSpinOrdChange/RSCXbody/RSCXitem/price/@currency) [Optional] (a)</p> <p>- nota: <i>Currency referred by the price.</i></p> <p>(XPath RAWSpinOrdChange/terms/allowanceCharge/AC_amount/@currency) [Optional] (a)</p>
@CV	<p>coefficient of variation (CV) of a measurement</p> <p>- base type: decimal,</p> <p>(XPath RAWSpinOrdChange/RSCXbody/RSCXitem/yarnProd/yarnSpecs/specValue/@CV) [Optional]</p> <p>(XPath RAWSpinOrdChange/RSCXbody/RSCXitem/yarnMnfrOperation/yarnMachineSpecs/specValue/@CV) [Optional]</p>
@dateForm	<p>format used for the date</p> <p>- base type: string, cod. table: NT29</p> <p>http://www.ebiz.enea.it/moda-ml/repository/codelist/v2018-1/gc_NT29.xml</p> <p>(XPath RAWSpinOrdChange/RSCXbody/RSCXitem/rawMnfrOperation/refDoc/docDate/@dateForm) [Optional]</p> <p>(XPath RAWSpinOrdChange/RSCXbody/RSCXitem/deliveryDate/@dateForm) [Optional]</p> <p>(XPath RAWSpinOrdChange/RSCXheader/refDoc/docDate/@dateForm) [Optional]</p> <p>(XPath RAWSpinOrdChange/terms/transInfo/despatchDate/@dateForm) [Optional] (a)</p>

	<p>(XPath RAWSpinOrdChange/RSCXbody/RSCXitem/rawComponent/refDoc/docDate/@dateForm) [Optional]</p> <p>(XPath RAWSpinOrdChange/terms/transInfo/delEffectiveDate/@dateForm) [Optional]</p> <p>(XPath RAWSpinOrdChange/RSCXbody/RSCXitem/yarnMnfrOperation/refDoc/docDate/@dateForm) [Optional]</p> <p>(XPath RAWSpinOrdChange/RSCXbody/RSCXitem/refDoc/docDate/@dateForm) [Optional]</p> <p>(XPath RAWSpinOrdChange/RSCXheader/msgDate/@dateForm) [Optional]</p> <p>(XPath RAWSpinOrdChange/RSCXbody/RSCXitem/yarnProd/colorCardItem/refDoc/docDate/@dateForm) [Optional]</p>
delEffectiveDate	<p>effective date of delivery of goods (declared in Despatch), according to one of the patterns YYYY-MM-DD, YYYY-MM-DD:HH-MM or YYYY-WW.</p> <p>- base type: string,</p> <p>(XPath RAWSpinOrdChange/terms/transInfo/delEffectiveDate) 0-1 (p)</p>
deliveryDate	<p>date of delivery of goods, requested or promised in the purchase process, according to one of the patterns YYYY-MM-DD, YYYY-MM-DD:HH-MM or YYYY-WW.</p> <p>- base type: string,</p> <p>(XPath RAWSpinOrdChange/RSCXbody/RSCXitem/deliveryDate) 0-1</p>
deliveryPlace	<p>place of delivery of goods, ultimate or related to a given leg</p> <p>- base type: string, max length: 250,</p> <p>(XPath RAWSpinOrdChange/terms/transInfo/deliveryPlace) 0-1 (U)</p>
dept	<p>name or code of a contact department within a Party</p> <p>- base type: string, max length: 40,</p> <p>(XPath RAWSpinOrdChange/RSCXheader/thirdParty/dept) 0-1</p> <p>(XPath RAWSpinOrdChange/RSCXheader/subContractor/dept) 0-1</p> <p>(XPath RAWSpinOrdChange/RSCXbody/RSCXitem/thirdParty/dept) 0-1</p> <p>(XPath RAWSpinOrdChange/RSCXheader/buyer/dept) 0-1</p>
description	<p>free text description. The content of the element must be unique, it might be translated and repeated into more languages (thus no more than one instance for each language).</p> <p>- base type: string, max length: 250,</p> <p>(XPath RAWSpinOrdChange/RSCXbody/RSCXitem/yarnProd/yarnCode/description) 0-unbounded (AU)</p> <p>- note: <i>Product description</i></p> <p>(XPath RAWSpinOrdChange/RSCXbody/RSCXitem/yarnProd/colorCardItem/description) 0-unbounded (AU)</p> <p>(XPath RAWSpinOrdChange/RSCXbody/RSCXitem/rawComponent/rawCode/description) 0-unbounded (AU)</p> <p>- note: <i>Raw material description</i></p>
despatchDate	<p>date of despatch of goods, requested or promised in the purchase process, according to one of the patterns YYYY-MM-DD, YYYY-MM-DD:HH-MM or YYYY-WW.</p> <p>- base type: string,</p> <p>(XPath RAWSpinOrdChange/terms/transInfo/despatchDate) 0-1 (N)</p>
despatchPlace	<p>place of despatch of goods, origin or related to a given leg</p> <p>- base type: string, max length: 250,</p> <p>(XPath RAWSpinOrdChange/terms/transInfo/despatchPlace) 0-1 (N)</p>
docDate	<p>date of issue of the referenced document, according to one of the patterns YYYY-MM-DD, YYYY-MM-DD:HH-MM or YYYY-WW.</p> <p>- base type: string,</p> <p>(XPath RAWSpinOrdChange/RSCXbody/RSCXitem/refDoc/docDate) 0-1</p> <p>(XPath RAWSpinOrdChange/RSCXheader/refDoc/docDate) 0-1</p> <p>(XPath RAWSpinOrdChange/RSCXbody/RSCXitem/rawComponent/refDoc/docDate) 0-1</p> <p>(XPath RAWSpinOrdChange/RSCXbody/RSCXitem/yarnProd/colorCardItem/refDoc/docDate) 0-1</p>

	<p>(XPath RAWSpinOrdChange/RSCXbody/RSCXitem/yarnMnfrOperation/refDoc/docDate) 0-1</p> <p>(XPath RAWSpinOrdChange/RSCXbody/RSCXitem/rawMnfrOperation/refDoc/docDate) 0-1</p>
docID	<p>identification number of the referenced document SINCE 2008-1 ITS USE IN THE HEADER IS DISCOURAGED (REPLACED BY msgID)</p> <p>- base type: string, max length: 80,</p> <p>(XPath RAWSpinOrdChange/RSCXbody/RSCXitem/yarnMnfrOperation/refDoc/docID) 1-2 (p)</p> <hr/> <p>AAAA-WARNING! - text not AVAILABLE n. 245 - In=en (XPath RAWSpinOrdChange/RSCXbody/RSCXitem/rawComponent/refDoc/docID) 1-2</p> <hr/> <p>AAAA-WARNING! - text not AVAILABLE n. 245 - In=en (XPath RAWSpinOrdChange/RSCXbody/RSCXitem/rawMnfrOperation/refDoc/docID) 1-2 (p)</p> <hr/> <p>AAAA-WARNING! - text not AVAILABLE n. 245 - In=en (XPath RAWSpinOrdChange/RSCXheader/docID) 0-1 (XPath RAWSpinOrdChange/RSCXbody/RSCXitem/refDoc/docID) 1-2 (p)</p> <hr/> <p>AAAA-WARNING! - text not AVAILABLE n. 245 - In=en (XPath RAWSpinOrdChange/RSCXbody/RSCXitem/yarnProd/colorCardItem/refDoc/docID) 1-2 (p)</p> <hr/> <p>AAAA-WARNING! - text not AVAILABLE n. 245 - In=en (XPath RAWSpinOrdChange/RSCXheader/refDoc/docID) 1-2 (p)</p> <hr/> <p>AAAA-WARNING! - text not AVAILABLE n. 245 - In=en</p>
@docType	<p>type or class to which the referenced document belongs</p> <p>- base type: string, cod. table: T21 http://www.ebiz.enea.it/moda-ml/repository/codelist/v2018-1/gc_T21.xml</p> <p>(XPath RAWSpinOrdChange/RSCXbody/RSCXitem/rawMnfrOperation/refDoc/@docType) [Required]</p> <p>(XPath RAWSpinOrdChange/RSCXbody/RSCXitem/yarnMnfrOperation/refDoc/@docType) [Required]</p> <p>(XPath RAWSpinOrdChange/RSCXbody/RSCXitem/refDoc/@docType) [Required]</p> <p>(XPath RAWSpinOrdChange/RSCXheader/refDoc/@docType) [Required]</p> <p>(XPath RAWSpinOrdChange/RSCXbody/RSCXitem/yarnProd/colorCardItem/refDoc/@docType) [Required]</p> <p>(XPath RAWSpinOrdChange/RSCXbody/RSCXitem/rawComponent/refDoc/@docType) [Required]</p>
dyeN	<p>number of the dyeing batch of a textile product</p> <p>- base type: string, max length: 15,</p> <p>(XPath RAWSpinOrdChange/RSCXbody/RSCXitem/rawComponent/dyeN) 0-1</p> <p>(XPath RAWSpinOrdChange/RSCXbody/RSCXitem/yarnProd/dyeN) 0-1</p> <p>- note: <i>identifier that the Subcontractor is requested to assign to the present dyeing bath - to be used only in the Dyeing Order</i></p>
@email	<p>electronic mail address of the contact person within a Party</p> <p>- base type: string, max length: 250,</p> <p>(XPath RAWSpinOrdChange/RSCXheader/buyer/person/@email) [Optional]</p> <p>(XPath RAWSpinOrdChange/RSCXheader/thirdParty/person/@email) [Optional]</p> <p>(XPath RAWSpinOrdChange/RSCXbody/RSCXitem/thirdParty/person/@email) [Optional]</p> <p>(XPath RAWSpinOrdChange/RSCXheader/subContractor/person/@email) [Optional]</p>
@encoding	<p>specifies the decoding algorithm of the binary object</p> <p>- base type: normalizedString,</p>

	<p>(XPath RAWSpinOrdChange/RSCXbody/RSCXitem/refDoc/attachment/binaryObject/@encoding) [Optional] (Na)</p> <p>(XPath RAWSpinOrdChange/RSCXbody/RSCXitem/rawMnfrOperation/refDoc/attachment/binaryObject/@encoding) [Optional] (Na)</p> <p>(XPath RAWSpinOrdChange/RSCXbody/RSCXitem/yarnProd/colorCardItem/refDoc/attachment/binaryObject/@encoding) [Optional] (Na)</p> <p>(XPath RAWSpinOrdChange/RSCXbody/RSCXitem/rawComponent/refDoc/attachment/binaryObject/@encoding) [Optional] (Na)</p> <p>(XPath RAWSpinOrdChange/RSCXheader/refDoc/attachment/binaryObject/@encoding) [Optional] (N)</p> <p>(XPath RAWSpinOrdChange/RSCXbody/RSCXitem/yarnMnfrOperation/refDoc/attachment/binaryObject/@encoding) [Optional] (Na)</p>
encodingCode	<p>the encoding/decoding algorithm used with the external object (example is 'base64Binary')</p> <p>- base type: normalizedString,</p> <p>(XPath RAWSpinOrdChange/RSCXbody/RSCXitem/rawMnfrOperation/refDoc/attachment/externalReference/encodingCode) 0-1 (N)</p> <p>(XPath RAWSpinOrdChange/RSCXbody/RSCXitem/refDoc/attachment/externalReference/encodingCode) 0-1 (N)</p> <p>(XPath RAWSpinOrdChange/RSCXheader/refDoc/attachment/externalReference/encodingCode) 0-1 (N)</p> <p>(XPath RAWSpinOrdChange/RSCXbody/RSCXitem/yarnProd/colorCardItem/refDoc/attachment/externalReference/encodingCode) 0-1 (N)</p> <p>(XPath RAWSpinOrdChange/RSCXbody/RSCXitem/rawComponent/refDoc/attachment/externalReference/encodingCode) 0-1 (N)</p> <p>(XPath RAWSpinOrdChange/RSCXbody/RSCXitem/yarnMnfrOperation/refDoc/attachment/externalReference/encodingCode) 0-1 (N)</p>
experimValue	<p>experimental value of the measurement</p> <p>- base type: decimal,</p> <p>(XPath RAWSpinOrdChange/RSCXbody/RSCXitem/yarnProd/yarnSpecs/experimValue) 0-1</p>
@fax	<p>fax number of the contact person within a Party</p> <p>- base type: string, max length: 35,</p> <p>(XPath RAWSpinOrdChange/RSCXheader/subContractor/person/@fax) [Optional]</p> <p>(XPath RAWSpinOrdChange/RSCXheader/buyer/person/@fax) [Optional]</p> <p>(XPath RAWSpinOrdChange/RSCXheader/thirdParty/person/@fax) [Optional]</p> <p>(XPath RAWSpinOrdChange/RSCXbody/RSCXitem/thirdParty/person/@fax) [Optional]</p>
@fibre	<p>type of fibre used in a textile product</p> <p>- base type: string, cod. table: T19</p> <p>http://www.ebiz.enea.it/moda-ml/repository/codelist/v2018-1/gc_T19.xml</p> <p>(XPath RAWSpinOrdChange/RSCXbody/RSCXitem/yarnProd/yarnCompos/percCompos/@fibre) [Required]</p>
fileName	<p>unique identifier (name) of the file</p> <p>- base type: string, max length: 255,</p> <p>(XPath RAWSpinOrdChange/RSCXbody/RSCXitem/yarnMnfrOperation/refDoc/attachment/fileName) 0-1 (N)</p> <p>(XPath RAWSpinOrdChange/RSCXheader/refDoc/attachment/fileName) 0-1 (N)</p> <p>(XPath RAWSpinOrdChange/RSCXbody/RSCXitem/rawMnfrOperation/refDoc/attachment/fileName) 0-1 (N)</p> <p>(XPath RAWSpinOrdChange/RSCXbody/RSCXitem/refDoc/attachment/fileName) 0-1 (N)</p> <p>(XPath RAWSpinOrdChange/RSCXbody/RSCXitem/yarnProd/colorCardItem/refDoc/attachment/fileName) 0-1 (N)</p> <p>(XPath RAWSpinOrdChange/RSCXbody/RSCXitem/rawComponent/refDoc/attachment/fileName) 0-1 (N)</p>

<i>@finDiscount</i>	financial discount rate applied for payment by the date specified - base type: decimal, min inclusive: 0, max inclusive: 100, fraction digits: 2, (XPath RAWSpinOrdChange/terms/payment/@finDiscount) [Optional]
<i>@finSurcharge</i>	financial surcharge rate applied for payment after the date specified - base type: decimal, min inclusive: 0, max inclusive: 100, fraction digits: 2, (XPath RAWSpinOrdChange/terms/payment/@finSurcharge) [Optional]
<i>@format</i>	the format of the binary content (examples xml, pdf, doc,...) - base type: string, (XPath RAWSpinOrdChange/RSCXbody/RSCXitem/yarnProd/colorCardItem/refDoc/attachment/binaryObject/@format) [Optional] (Na) (XPath RAWSpinOrdChange/RSCXbody/RSCXitem/rawMnfrOperation/refDoc/attachment/binaryObject/@format) [Optional] (Na) (XPath RAWSpinOrdChange/RSCXbody/RSCXitem/refDoc/attachment/binaryObject/@format) [Optional] (Na) (XPath RAWSpinOrdChange/RSCXbody/RSCXitem/rawComponent/refDoc/attachment/binaryObject/@format) [Optional] (Na) (XPath RAWSpinOrdChange/RSCXheader/refDoc/attachment/binaryObject/@format) [Optional] (N) (XPath RAWSpinOrdChange/RSCXbody/RSCXitem/yarnMnfrOperation/refDoc/attachment/binaryObject/@format) [Optional] (Na)
formatCode	the format of the external object (examples xml, pdf, doc,...) - base type: normalizedString, (XPath RAWSpinOrdChange/RSCXbody/RSCXitem/rawMnfrOperation/refDoc/attachment/externalReference/formatCode) 0-1 (N) (XPath RAWSpinOrdChange/RSCXbody/RSCXitem/yarnProd/colorCardItem/refDoc/attachment/externalReference/formatCode) 0-1 (N) (XPath RAWSpinOrdChange/RSCXbody/RSCXitem/refDoc/attachment/externalReference/formatCode) 0-1 (N) (XPath RAWSpinOrdChange/RSCXbody/RSCXitem/rawComponent/refDoc/attachment/externalReference/formatCode) 0-1 (N) (XPath RAWSpinOrdChange/RSCXbody/RSCXitem/yarnMnfrOperation/refDoc/attachment/externalReference/formatCode) 0-1 (N) (XPath RAWSpinOrdChange/RSCXheader/refDoc/attachment/externalReference/formatCode) 0-1 (N)
grossWeight	the gross weight, declared for transport or customs purpose - base type: decimal, min inclusive: 0, fraction digits: 2, (XPath RAWSpinOrdChange/terms/transInfo/grossWeight) 0-1
id	primary identification code of a Party; it is recommended the format: nation code (ISO 3166) + VAT identification number (11 crt), with the qualifier "numbingOrg"= MF - base type: string, max length: 15, (XPath RAWSpinOrdChange/RSCXheader/thirdParty/id) 1-1 (XPath RAWSpinOrdChange/RSCXheader/buyer/id) 1-1 (p) (XPath RAWSpinOrdChange/RSCXbody/RSCXitem/thirdParty/id) 1-1 (XPath RAWSpinOrdChange/RSCXheader/subContractor/id) 1-1
<i>@idCO</i>	primary identification code of the Party executing the test; it is recommended the format: nation code (ISO 3166) + VAT identification number (11 crt). - base type: string, max length: 15, (XPath RAWSpinOrdChange/RSCXbody/RSCXitem/yarnProd/yarnSpecs/experimValue/@idCO) [Optional]
<i>@idQualifier</i>	Qualification of the identifier. - base type: string, (XPath RAWSpinOrdChange/RSCXheader/buyer/additionalIdentifier/@idQualifier) [Optional] (Na)

	- nota: <i>this attribute should be used when the numberingOrg attribute is not enough to declare the type of identifier</i>
@illuminant	CIE light source - base type: string, cod. table: T59 http://www.ebiz.enea.it/moda-ml/repository/codelist/v2018-1/gc_T59.xml (XPath RAWSpinOrdChange/RSCXbody/RSCXitem/yarnProd/colorCardItem/CIELab/@illuminant) [Optional]
incoTerm	specification of the terms of trade (INCOTERMS) - base type: string, cod. table: T3 http://www.ebiz.enea.it/moda-ml/repository/codelist/v2018-1/gc_T3.xml (XPath RAWSpinOrdChange/terms/trade/incoTerm) 1-1
incoTermText	free text specifying the terms of trade (incoterm, location) - base type: string, max length: 250, (XPath RAWSpinOrdChange/terms/trade/incoTermText) 1-1 (U)
@isCharge	Indicates if the element to which it refers is a charge (true = charge, false = allowance) - base type: boolean, min length: 0, (XPath RAWSpinOrdChange/terms/allowanceCharge/@isCharge) [Optional] (N)
@isURL	it indicates if the referred element is an URL (true) or not (false) - base type: boolean, (XPath RAWSpinOrdChange/RSCXbody/RSCXitem/rawComponent/refDoc/attachment/externalReference/uri/@isURL) [Optional] [Default= true] (Na) - nota: <i>usage of URLs is recommended</i> (XPath RAWSpinOrdChange/RSCXbody/RSCXitem/yarnProd/colorCardItem/refDoc/attachment/externalReference/uri/@isURL) [Optional] [Default= true] (Na) - nota: <i>usage of URLs is recommended</i> (XPath RAWSpinOrdChange/RSCXbody/RSCXitem/yarnMnfrOperation/refDoc/attachment/externalReference/uri/@isURL) [Optional] [Default= true] (Na) - nota: <i>usage of URLs is recommended</i> (XPath RAWSpinOrdChange/RSCXbody/RSCXitem/refDoc/attachment/externalReference/uri/@isURL) [Optional] [Default= true] (Na) - nota: <i>usage of URLs is recommended</i> (XPath RAWSpinOrdChange/RSCXheader/refDoc/attachment/externalReference/uri/@isURL) [Optional] [Default= true] (Na) - nota: <i>usage of URLs is recommended</i> (XPath RAWSpinOrdChange/RSCXbody/RSCXitem/rawMnfrOperation/refDoc/attachment/externalReference/uri/@isURL) [Optional] [Default= true] (Na) - nota: <i>usage of URLs is recommended</i>
itemID	number of the line/item of the referenced document - base type: string, max length: 40, (XPath RAWSpinOrdChange/RSCXbody/RSCXitem/yarnMnfrOperation/refDoc/itemID) 0-1 (U) (XPath RAWSpinOrdChange/RSCXbody/RSCXitem/rawMnfrOperation/refDoc/itemID) 0-1 (U) (XPath RAWSpinOrdChange/RSCXheader/refDoc/itemID) 0-1 (U) (XPath RAWSpinOrdChange/RSCXbody/RSCXitem/refDoc/itemID) 0-1 (U) (XPath RAWSpinOrdChange/RSCXbody/RSCXitem/yarnProd/colorCardItem/refDoc/itemID) 0-1 (U) (XPath RAWSpinOrdChange/RSCXbody/RSCXitem/rawComponent/refDoc/itemID) 0-1 (U)
jobName	description of the elementary job - base type: string, max length: 40,

	<p>(XPath RAWSpinOrdChange/RSCXbody/RSCXitem/rawMnfrOperation/jobName) 1-1</p> <p>(XPath RAWSpinOrdChange/RSCXbody/RSCXitem/yarnMnfrOperation/jobName) 1-1</p>
L	<p>"L" value of the CIELab color system</p> <p>- base type: decimal, min inclusive: 0,</p> <p>(XPath RAWSpinOrdChange/RSCXbody/RSCXitem/yarnProd/colorCardItem/CIELab/L) 1-1</p>
label	<p>indicates if the physical object specified has to be labelled</p> <p>- base type: boolean,</p> <p>(XPath RAWSpinOrdChange/RSCXbody/RSCXitem/yarnProd/yarnPack/yarnReel/label) 0-1</p> <p>(XPath RAWSpinOrdChange/RSCXbody/RSCXitem/yarnProd/yarnPack/yarnInWrap/label) 0-1</p>
labelWrit	<p>text that must be written on the lable of a specified physical object when its customization is required</p> <p>- base type: string, max length: 350,</p> <p>(XPath RAWSpinOrdChange/RSCXbody/RSCXitem/yarnProd/yarnPack/yarnReel/labelWrit) 0-1</p> <p>(XPath RAWSpinOrdChange/RSCXbody/RSCXitem/yarnProd/yarnPack/yarnInWrap/labelWrit) 0-1</p>
legalName	<p>legal name of a Party</p> <p>- base type: string, max length: 250,</p> <p>(XPath RAWSpinOrdChange/RSCXbody/RSCXitem/thirdParty/legalName) 0-1 (U)</p> <p>(XPath RAWSpinOrdChange/RSCXheader/thirdParty/legalName) 0-1 (U)</p> <p>(XPath RAWSpinOrdChange/RSCXheader/buyer/legalName) 0-1 (U)</p> <p>(XPath RAWSpinOrdChange/RSCXheader/subContractor/legalName) 0-1 (U)</p>
legalRef	<p>legal reference of the duty or tax or fee category</p> <p>- base type: string,</p> <p>(XPath RAWSpinOrdChange/RSCXbody/RSCXitem/dtScheme/legalRef) 0-1 (A)</p> <p>(XPath RAWSpinOrdChange/terms/allowanceCharge/dtScheme/legalRef) 0-1 (A)</p>
lineN	<p>number of the line item of the present message (xml document); it is set by the role that produces the document. Usually it is a progressive number, but not always.</p> <p>- base type: positiveInteger, min inclusive: 1, max inclusive: 9999,</p> <p>(XPath RAWSpinOrdChange/RSCXbody/RSCXitem/lineN) 1-1</p>
@listName	<p>the name of the list of codes used to make an instance of the element (it might be thought as descriptive element, i.e. 'fabric printing technologies', or not, i.e. "T264")</p> <p>- base type: string, max length: 40,</p> <p>(XPath RAWSpinOrdChange/RSCXbody/RSCXitem/yarnProd/colorCardItem/refDoc/season/@listName) [Optional] (a)</p> <p>- nota: <i>this attribute should always be used coupled with "numberingOrg"</i></p> <p>(XPath RAWSpinOrdChange/RSCXheader/season/@listName) [Optional] (a)</p> <p>- nota: <i>this attribute should always be used coupled with "numberingOrg"</i></p> <p>(XPath RAWSpinOrdChange/terms/allowanceCharge/dtScheme/legalRef/@listName) [Optional]</p> <p>- nota: <i>this attribute should always be used coupled with "numberingOrg"</i></p> <p>(XPath RAWSpinOrdChange/RSCXbody/RSCXitem/yarnProd/yarnCode/art/@listName) [Optional]</p> <p>- nota: <i>this attribute should always be used coupled with "numberingOrg"</i></p> <p>(XPath RAWSpinOrdChange/RSCXbody/RSCXitem/rawComponent/rawCode/art/@listName) [Optional]</p> <p>- nota: <i>this attribute should always be used coupled with "numberingOrg"</i></p> <p>(XPath RAWSpinOrdChange/RSCXbody/RSCXitem/refDoc/season/@listName) [Optional] (a)</p> <p>- nota: <i>this attribute should always be used coupled with "numberingOrg"</i></p>

	<p>(XPath RAWSpinOrdChange/RSCXbody/RSCXitem/rawComponent/rawCode/color/@listName) [Optional]</p> <p>- nota: <i>this attribute should always be used coupled with “numberingOrg”</i> (XPath RAWSpinOrdChange/RSCXbody/RSCXitem/rawMnfrOperation/refDoc/season/@listName) [Optional] (a)</p> <p>- nota: <i>this attribute should always be used coupled with “numberingOrg”</i> (XPath RAWSpinOrdChange/RSCXbody/RSCXitem/dtScheme/legalRef/@listName) [Optional]</p> <p>- nota: <i>this attribute should always be used coupled with “numberingOrg”</i> (XPath RAWSpinOrdChange/RSCXbody/RSCXitem/yarnProd/colorCardItem/color/@listName) [Optional]</p> <p>- nota: <i>this attribute should always be used coupled with “numberingOrg”</i> (XPath RAWSpinOrdChange/RSCXheader/refDoc/season/@listName) [Optional] (a)</p> <p>- nota: <i>this attribute should always be used coupled with “numberingOrg”</i> (XPath RAWSpinOrdChange/RSCXbody/RSCXitem/yarnProd/yarnCode/color/@listName) [Optional]</p> <p>- nota: <i>this attribute should always be used coupled with “numberingOrg”</i> (XPath RAWSpinOrdChange/RSCXbody/RSCXitem/yarnMnfrOperation/refDoc/season/@listName) [Optional] (a)</p> <p>- nota: <i>this attribute should always be used coupled with “numberingOrg”</i> (XPath RAWSpinOrdChange/RSCXbody/RSCXitem/rawComponent/refDoc/season/@listName) [Optional] (a)</p> <p>- nota: <i>this attribute should always be used coupled with “numberingOrg”</i></p>
<p>@listVersion</p>	<p>it specifie the version of the list of codes used to make an instance of the element</p> <p>- base type: string, max length: 6, (XPath RAWSpinOrdChange/RSCXbody/RSCXitem/rawComponent/refDoc/season/@listVersion) [Optional] (a)</p> <p>- nota: <i>this attribute should always be used coupled with “numberingOrg” and “listName”</i> (XPath RAWSpinOrdChange/RSCXbody/RSCXitem/rawComponent/rawCode/color/@listVersion) [Optional]</p> <p>- nota: <i>this attribute should always be used coupled with “numberingOrg” and “listName”</i> (XPath RAWSpinOrdChange/RSCXbody/RSCXitem/yarnMnfrOperation/refDoc/season/@listVersion) [Optional] (a)</p> <p>- nota: <i>this attribute should always be used coupled with “numberingOrg” and “listName”</i> (XPath RAWSpinOrdChange/RSCXbody/RSCXitem/dtScheme/legalRef/@listVersion) [Optional]</p> <p>- nota: <i>this attribute should always be used coupled with “numberingOrg” and “listName”</i> (XPath RAWSpinOrdChange/RSCXheader/season/@listVersion) [Optional] (a)</p> <p>- nota: <i>this attribute should always be used coupled with “numberingOrg” and “listName”</i> (XPath RAWSpinOrdChange/RSCXbody/RSCXitem/rawComponent/rawCode/art/@listVersion) [Optional]</p> <p>- nota: <i>this attribute should always be used coupled with “numberingOrg” and “listName”</i> (XPath RAWSpinOrdChange/RSCXbody/RSCXitem/rawMnfrOperation/refDoc/season/@listVersion) [Optional] (a)</p> <p>- nota: <i>this attribute should always be used coupled with “numberingOrg” and “listName”</i> (XPath RAWSpinOrdChange/RSCXbody/RSCXitem/yarnProd/yarnCode/color/@listVersion) [Optional]</p> <p>- nota: <i>this attribute should always be used coupled with “numberingOrg” and “listName”</i> (XPath RAWSpinOrdChange/RSCXbody/RSCXitem/yarnProd/colorCardItem/refDoc/season/@listVersion) [Optional] (a)</p>

	<p>- nota: <i>this attribute should always be used coupled with “numberingOrg” and “listName”</i> (XPath RAWSpinOrdChange/RSCXheader/refDoc/season/@listVersion) [Optional] (a)</p> <p>- nota: <i>this attribute should always be used coupled with “numberingOrg” and “listName”</i> (XPath RAWSpinOrdChange/terms/allowanceCharge/dtScheme/legalRef/@listVersion) [Optional]</p> <p>- nota: <i>this attribute should always be used coupled with “numberingOrg” and “listName”</i> (XPath RAWSpinOrdChange/RSCXbody/RSCXitem/yarnProd/colorCardItem/color/@listVersion) [Optional]</p> <p>- nota: <i>this attribute should always be used coupled with “numberingOrg” and “listName”</i> (XPath RAWSpinOrdChange/RSCXbody/RSCXitem/refDoc/season/@listVersion) [Optional] (a)</p> <p>- nota: <i>this attribute should always be used coupled with “numberingOrg” and “listName”</i> (XPath RAWSpinOrdChange/RSCXbody/RSCXitem/yarnProd/yarnCode/art/@listVersion) [Optional]</p> <p>- nota: <i>this attribute should always be used coupled with “numberingOrg” and “listName”</i></p>
@ln	<p>Language code. - base type: string, cod. table: NT60 http://www.ebiz.enea.it/moda-ml/repository/codelist/v2018-1/gc_NT60.xml (XPath RAWSpinOrdChange/RSCXbody/RSCXitem/yarnProd/colorCardItem/description/@ln) [Optional] (N) (XPath RAWSpinOrdChange/RSCXbody/RSCXitem/yarnProd/yarnCode/description/@ln) [Optional] (N) (XPath RAWSpinOrdChange/RSCXbody/RSCXitem/rawComponent/rawCode/description/@ln) [Optional] (N)</p>
location	<p>specification of a location - base type: string, max length: 40, (XPath RAWSpinOrdChange/terms/trade/location) 0-1 - note: <i>place to which the INCOTERM applies</i> (XPath RAWSpinOrdChange/RSCXbody/RSCXitem/rawComponent/location) 0-1</p>
@logo	<p>company logo (URL of the image jpeg or gif). It is recommended that the width of the image does not exceed 640 pixel. - base type: string, max length: 255, (XPath RAWSpinOrdChange/RSCXheader/buyer/@logo) [Optional]</p>
lotN	<p>lot number of a product or batch number of the raw material - base type: string, max length: 15, (XPath RAWSpinOrdChange/RSCXbody/RSCXitem/yarnProd/lotN) 0-1 - note: <i>identifier that the Subcontractor is requested to assign to the present production lot</i> (XPath RAWSpinOrdChange/RSCXbody/RSCXitem/rawComponent/lotN) 0-1</p>
@LRI	<p>attribute usable to format a string according to a customized User rule (local rule) - base type: string, cod. table: NT3 http://www.ebiz.enea.it/moda-ml/repository/codelist/v2018-1/gc_NT3.xml (XPath RAWSpinOrdChange/terms/trade/location/@LRI) [Optional] (XPath RAWSpinOrdChange/RSCXbody/RSCXitem/rawComponent/location/@LRI) [Optional]</p>
@maxQty	<p>maximum product quantity - base type: decimal, min inclusive: 0, fraction digits: 2, (XPath RAWSpinOrdChange/terms/allowanceCharge/@maxQty) [Optional] (N) - nota: <i>maximum quantity of product for the application of this allowance or charge</i></p>

@method	<p>standard protocol or method employed in a test to evaluate a characteristic or a parameter</p> <ul style="list-style-type: none"> - base type: string, max length: 80, <p>(XPath RAWSpinOrdChange/RSCXbody/RSCXitem/yarnProd/yarnSpecs/specValue/@method) [Optional]</p> <p>(XPath RAWSpinOrdChange/RSCXbody/RSCXitem/yarnMnfrOperation/yarnMachineSpecs/specValue/@method) [Optional]</p> <p>(XPath RAWSpinOrdChange/RSCXbody/RSCXitem/yarnProd/yarnSpecs/experimValue/@method) [Optional]</p> <ul style="list-style-type: none"> - nota: <i>we recommend the specification of the method of measure only when different from the one of the MODA-ML coding system</i>
@mime	<p>the mime type of the binary object</p> <ul style="list-style-type: none"> - base type: normalizedString, <p>(XPath RAWSpinOrdChange/RSCXbody/RSCXitem/yarnProd/colorCardItem/refDoc/attachment/binaryObject/@mime) [Optional] (Na)</p> <p>(XPath RAWSpinOrdChange/RSCXbody/RSCXitem/yarnMnfrOperation/refDoc/attachment/binaryObject/@mime) [Optional] (Na)</p> <p>(XPath RAWSpinOrdChange/RSCXbody/RSCXitem/rawComponent/refDoc/attachment/binaryObject/@mime) [Optional] (Na)</p> <p>(XPath RAWSpinOrdChange/RSCXbody/RSCXitem/refDoc/attachment/binaryObject/@mime) [Optional] (Na)</p> <p>(XPath RAWSpinOrdChange/RSCXbody/RSCXitem/rawMnfrOperation/refDoc/attachment/binaryObject/@mime) [Optional] (Na)</p> <p>(XPath RAWSpinOrdChange/RSCXheader/refDoc/attachment/binaryObject/@mime) [Optional] (N)</p>
mimeCode	<p>mime type of the external object</p> <ul style="list-style-type: none"> - base type: normalizedString, <p>(XPath RAWSpinOrdChange/RSCXheader/refDoc/attachment/externalReference/mimeCode) 0-1 (N)</p> <hr/> <p>AAAA-WARNING! - text not AVAILABLE n. 245 - In=en (XPath RAWSpinOrdChange/RSCXbody/RSCXitem/rawComponent/refDoc/attachment/externalReference/mimeCode) 0-1 (N)</p> <hr/> <p>AAAA-WARNING! - text not AVAILABLE n. 245 - In=en (XPath RAWSpinOrdChange/RSCXbody/RSCXitem/refDoc/attachment/externalReference/mimeCode) 0-1 (N)</p> <hr/> <p>AAAA-WARNING! - text not AVAILABLE n. 245 - In=en (XPath RAWSpinOrdChange/RSCXbody/RSCXitem/rawMnfrOperation/refDoc/attachment/externalReference/mimeCode) 0-1 (N)</p> <hr/> <p>AAAA-WARNING! - text not AVAILABLE n. 245 - In=en (XPath RAWSpinOrdChange/RSCXbody/RSCXitem/yarnProd/colorCardItem/refDoc/attachment/externalReference/mimeCode) 0-1 (N)</p> <hr/> <p>AAAA-WARNING! - text not AVAILABLE n. 245 - In=en (XPath RAWSpinOrdChange/RSCXbody/RSCXitem/yarnMnfrOperation/refDoc/attachment/externalReference/mimeCode) 0-1 (N)</p> <hr/> <p>AAAA-WARNING! - text not AVAILABLE n. 245 - In=en</p>
@minQty	<p>minimum product quantity</p> <ul style="list-style-type: none"> - base type: decimal, min inclusive: 0, fraction digits: 2, <p>(XPath RAWSpinOrdChange/terms/allowanceCharge/@minQty) [Optional] (a)</p> <ul style="list-style-type: none"> - nota: <i>minimum quantity of product for the application of this allowance or charge</i>
msgCurrency	<p>currency used to express the monetary amounts of the message</p> <ul style="list-style-type: none"> - base type: string, cod. table: T9 <p>http://www.ebiz.enea.it/moda-ml/repository/codelist/v2018-1/gc_T9.xml</p> <p>(XPath RAWSpinOrdChange/RSCXheader/msgCurrency) 0-1</p>

msgDate	<p>date of issue of the present message (xml document), according to one of the patterns YYYY-MM-DD, YYYY-MM-DD:HH-MM or YYYY-WW.</p> <p>- base type: string, (XPath RAWSpinOrdChange/RSCXheader/msgDate) 1-1</p>
@msgfunction	<p>function performed by the present message with regards to the transmission</p> <p>- base type: string, cod. table: NT18 http://www.ebiz.enea.it/moda-ml/repository/codelist/v2018-1/gc_NT18.xml (XPath RAWSpinOrdChange/@msgfunction) [Optional] [Default= OR]</p>
msgID	<p>key identifier of the business document in the information system of the issuing Party. In case of more despatches of the same business document, it is unchanged.</p> <p>- base type: string, max length: 35, (XPath RAWSpinOrdChange/RSCXheader/msgID) 0-1</p>
msgN	<p>identification number given to the message (xml document) by its issuer. In case of more despatches of the same business document, it changes.</p> <p>- base type: string, max length: 35, (XPath RAWSpinOrdChange/RSCXheader/msgN) 1-1</p>
netWeight	<p>the net weight declared for transport or customs purpose</p> <p>- base type: decimal, min inclusive: 0, fraction digits: 2, (XPath RAWSpinOrdChange/terms/transInfo/netWeight) 0-1</p>
note	<p>free text or structured (computer processing) note. For note structuring use the attributes "noteLabel" and "codelist"</p> <p>- base type: string, max length: 350, (XPath RAWSpinOrdChange/RSCXbody/RSCXitem/note) 0-99 (XPath RAWSpinOrdChange/RSCXheader/note) 0-99 (XPath RAWSpinOrdChange/RSCXbody/RSCXitem/rawMnfrOperation/note) 0-99 (XPath RAWSpinOrdChange/RSCXbody/RSCXitem/yarnProd/note) 0-99 (XPath RAWSpinOrdChange/terms/allowanceCharge/dtScheme/note) 0-99 (XPath RAWSpinOrdChange/RSCXbody/RSCXitem/rawComponent/note) 0-99 (XPath RAWSpinOrdChange/RSCXbody/RSCXitem/yarnMnfrOperation/note) 0-99 (XPath RAWSpinOrdChange/RSCXbody/RSCXitem/dtScheme/note) 0-99</p>
@noteLabel	<p>subject qualifier of a note</p> <p>- base type: string, max length: 35, (XPath RAWSpinOrdChange/terms/allowanceCharge/dtScheme/note/@noteLabel) [Optional]</p> <p>- nota: <i>must be used to qualify the subject of the note</i> (XPath RAWSpinOrdChange/RSCXheader/note/@noteLabel) [Optional]</p> <p>- nota: <i>must be used to qualify the subject of the note</i> (XPath RAWSpinOrdChange/RSCXbody/RSCXitem/dtScheme/note/@noteLabel) [Optional]</p> <p>- nota: <i>must be used to qualify the subject of the note</i> (XPath RAWSpinOrdChange/RSCXbody/RSCXitem/rawMnfrOperation/note/@noteLabel) [Optional]</p> <p>- nota: <i>must be used to qualify the subject of the note</i> (XPath RAWSpinOrdChange/RSCXbody/RSCXitem/rawComponent/note/@noteLabel) [Optional]</p> <p>- nota: <i>must be used to qualify the subject of the note</i> (XPath RAWSpinOrdChange/RSCXbody/RSCXitem/yarnMnfrOperation/note/@noteLabel) [Optional]</p> <p>- nota: <i>must be used to qualify the subject of the note</i> (XPath RAWSpinOrdChange/RSCXbody/RSCXitem/yarnProd/note/@noteLabel) [Optional]</p> <p>- nota: <i>must be used to qualify the subject of the note</i> (XPath RAWSpinOrdChange/RSCXbody/RSCXitem/note/@noteLabel) [Optional]</p> <p>- nota: <i>must be used to qualify the subject of the note</i></p>

<p>@numberingOrg</p>	<p>code specifying the organisation who has created or owns the coding or numbering system</p> <ul style="list-style-type: none"> - base type: string, cod. table: NT6 http://www.ebiz.enea.it/moda-ml/repository/codelist/v2018-1/gc_NT6.xml (XPath RAWSpinOrdChange/RSCXbody/RSCXitem/rawMnfrOperation/refDoc/attachment/fileName/@numberingOrg) [Optional] (a) (XPath RAWSpinOrdChange/RSCXbody/RSCXitem/yarnMnfrOperation/refDoc/attachment/fileName/@numberingOrg) [Optional] (a) (XPath RAWSpinOrdChange/RSCXbody/RSCXitem/rawComponent/dyeN/@numberingOrg) [Optional] (XPath RAWSpinOrdChange/RSCXbody/RSCXitem/yarnMnfrOperation/note/@numberingOrg) [Optional] - nota: <i>must be used to specify the organization that created the list of codes used in "noteLabel"</i> (XPath RAWSpinOrdChange/RSCXheader/note/@numberingOrg) [Optional] - nota: <i>must be used to specify the organization that created the list of codes used in "noteLabel"</i> (XPath RAWSpinOrdChange/RSCXbody/RSCXitem/refDoc/docID/@numberingOrg) [Optional] - nota: <i>here can be specified whose document numbering is used (e.g.: Client, Supplier, ..)</i> (XPath RAWSpinOrdChange/RSCXbody/RSCXitem/rawComponent/rawCode/added/@numberingOrg) [Optional] - nota: <i>this attribute should be used either single or coupled with "listName" and "listVersion"</i> (XPath RAWSpinOrdChange/RSCXbody/RSCXitem/rawComponent/lotN/@numberingOrg) [Optional] (XPath RAWSpinOrdChange/RSCXbody/RSCXitem/rawComponent/refDoc/attachment/fileName/@numberingOrg) [Optional] (a) (XPath RAWSpinOrdChange/RSCXbody/RSCXitem/rawMnfrOperation/note/@numberingOrg) [Optional] - nota: <i>must be used to specify the organization that created the list of codes used in "noteLabel"</i> (XPath RAWSpinOrdChange/RSCXbody/RSCXitem/rawMnfrOperation/refDoc/docID/@numberingOrg) [Optional] - nota: <i>here can be specified whose document numbering is used (e.g.: Client, Supplier, ..)</i> (XPath RAWSpinOrdChange/RSCXbody/RSCXitem/yarnMnfrOperation/refDoc/season/@numberingOrg) [Optional] (a) - nota: <i>this attribute should be used either single or coupled with "listName" and "listVersion"</i> (XPath RAWSpinOrdChange/RSCXbody/RSCXitem/yarnMnfrOperation/refDoc/docID/@numberingOrg) [Optional] - nota: <i>here can be specified whose document numbering is used (e.g.: Client, Supplier, ..)</i> (XPath RAWSpinOrdChange/RSCXbody/RSCXitem/rawComponent/note/@numberingOrg) [Optional] - nota: <i>must be used to specify the organization that created the list of codes used in "noteLabel"</i> (XPath RAWSpinOrdChange/RSCXheader/season/@numberingOrg) [Optional] (a) - nota: <i>this attribute should be used either single or coupled with "listName" and "listVersion"</i> (XPath RAWSpinOrdChange/RSCXbody/RSCXitem/rawMnfrOperation/refDoc/season/@numberingOrg) [Optional] (a) - nota: <i>this attribute should be used either single or coupled with "listName" and "listVersion"</i>
----------------------	--

(XPath RAWSpinOrdChange/RSCXbody/RSCXitem/rawComponent/refDoc/docID/@numberingOrg) [Optional]
- nota: here can be specified whose document numbering is used (e.g.: Client, Supplier, ..)

(XPath RAWSpinOrdChange/RSCXheader/thirdParty/id/@numberingOrg) [Optional]
(XPath RAWSpinOrdChange/terms/allowanceCharge/dtScheme/note/@numberingOrg) [Optional]
- nota: must be used to specify the organization that created the list of codes used in "noteLabel"

(XPath RAWSpinOrdChange/RSCXheader/docID/@numberingOrg) [Optional]
- nota: here can be specified whose document numbering is used (e.g.: Client, Supplier, ..)

(XPath RAWSpinOrdChange/RSCXbody/RSCXitem/note/@numberingOrg) [Optional]
- nota: must be used to specify the organization that created the list of codes used in "noteLabel"

(XPath RAWSpinOrdChange/RSCXbody/RSCXitem/rawComponent/refDoc/season/@numberingOrg) [Optional] (a)
- nota: this attribute should be used either single or coupled with "listName" and "listVersion"

(XPath RAWSpinOrdChange/terms/allowanceCharge/dtScheme/legalRef/@numberingOrg) [Optional]
- nota: this attribute should be used either single or coupled with "listName" and "listVersion"

(XPath RAWSpinOrdChange/RSCXbody/RSCXitem/refDoc/season/@numberingOrg) [Optional] (a)
- nota: this attribute should be used either single or coupled with "listName" and "listVersion"

(XPath RAWSpinOrdChange/RSCXheader/refDoc/season/@numberingOrg) [Optional] (a)
- nota: this attribute should be used either single or coupled with "listName" and "listVersion"

(XPath RAWSpinOrdChange/RSCXbody/RSCXitem/yarnProd/yarnCode/added/@numberingOrg) [Optional]
- nota: this attribute should be used either single or coupled with "listName" and "listVersion"

(XPath RAWSpinOrdChange/RSCXbody/RSCXitem/yarnProd/dyeN/@numberingOrg) [Optional]
(XPath RAWSpinOrdChange/RSCXbody/RSCXitem/yarnProd/colorCardItem/refDoc/docID/@numberingOrg) [Optional]
- nota: here can be specified whose document numbering is used (e.g.: Client, Supplier, ..)

(XPath RAWSpinOrdChange/RSCXbody/RSCXitem/yarnProd/yarnCode/color/@numberingOrg) [Optional]
- nota: this attribute should be used either single or coupled with "listName" and "listVersion"

(XPath RAWSpinOrdChange/RSCXbody/RSCXitem/yarnProd/lotN/@numberingOrg) [Optional]
(XPath RAWSpinOrdChange/RSCXbody/RSCXitem/yarnProd/colorCardItem/color/@numberingOrg) [Optional]
- nota: this attribute should be used either single or coupled with "listName" and "listVersion"

(XPath RAWSpinOrdChange/RSCXbody/RSCXitem/dtScheme/legalRef/@numberingOrg) [Optional]
- nota: this attribute should be used either single or coupled with "listName" and "listVersion"

(XPath RAWSpinOrdChange/RSCXbody/RSCXitem/dtScheme/note/@numberingOrg) [Optional]
- nota: must be used to specify the organization that created the list of codes used in "noteLabel"

(XPath RAWSpinOrdChange/RSCXheader/refDoc/docID/@numberingOrg) [Optional]
- nota: here can be specified whose document numbering is used (e.g.: Client, Supplier, ..)

	<p>(XPath RAWSpinOrdChange/RSCXbody/RSCXitem/thirdParty/id/@numberingOrg) [Optional]</p> <p>(XPath RAWSpinOrdChange/RSCXheader/buyer/additionalIdentifier/@numberingOrg) [Optional] (a)</p> <p>- nota: <i>here the issuer of the identifier must be specified</i></p> <p>(XPath RAWSpinOrdChange/RSCXbody/RSCXitem/yarnProd/note/@numberingOrg) [Optional]</p> <p>- nota: <i>must be used to specify the organization that created the list of codes used in "noteLabel"</i></p> <p>(XPath RAWSpinOrdChange/RSCXbody/RSCXitem/refDoc/attachment/fileName/@numberingOrg) [Optional] (a)</p> <p>(XPath RAWSpinOrdChange/RSCXbody/RSCXitem/rawComponent/rawCode/art/@numberingOrg) [Optional]</p> <p>- nota: <i>this attribute should be used either single or coupled with "listName" and "listVersion"</i></p> <p>(XPath RAWSpinOrdChange/RSCXheader/refDoc/attachment/fileName/@numberingOrg) [Optional]</p> <p>(XPath RAWSpinOrdChange/RSCXbody/RSCXitem/yarnProd/colorCardItem/refDoc/attachment/fileName/@numberingOrg) [Optional] (a)</p> <p>(XPath RAWSpinOrdChange/RSCXheader/subContractor/id/@numberingOrg) [Optional]</p> <p>(XPath RAWSpinOrdChange/RSCXbody/RSCXitem/rawComponent/rawCode/color/@numberingOrg) [Optional]</p> <p>- nota: <i>this attribute should be used either single or coupled with "listName" and "listVersion"</i></p> <p>(XPath RAWSpinOrdChange/RSCXbody/RSCXitem/rawComponent/rawCode/@numberingOrg) [Optional]</p> <p>(XPath RAWSpinOrdChange/RSCXheader/buyer/id/@numberingOrg) [Optional]</p> <p>(XPath RAWSpinOrdChange/RSCXbody/RSCXitem/yarnProd/colorCardItem/refDoc/season/@numberingOrg) [Optional] (a)</p> <p>- nota: <i>this attribute should be used either single or coupled with "listName" and "listVersion"</i></p> <p>(XPath RAWSpinOrdChange/RSCXbody/RSCXitem/yarnProd/yarnCode/art/@numberingOrg) [Optional]</p> <p>- nota: <i>this attribute should be used either single or coupled with "listName" and "listVersion"</i></p> <p>(XPath RAWSpinOrdChange/RSCXbody/RSCXitem/yarnProd/yarnCode/@numberingOrg) [Optional] [Default= CL]</p>
@part	<p>percent fraction of a total payment</p> <p>- base type: decimal, min inclusive: 1, max inclusive: 99, fraction digits: 2,</p> <p>(XPath RAWSpinOrdChange/terms/insPayment/@part) [Required]</p> <p>- nota: <i>here the % value of each installment must be indicated</i></p>
payMode	<p>way or means of payment</p> <p>- base type: string, cod. table: T2</p> <p>http://www.ebiz.enea.it/moda-ml/repository/codelist/v2018-1/gc_T2.xml</p> <p>(XPath RAWSpinOrdChange/terms/payment/payMode) 0-1</p> <p>(XPath RAWSpinOrdChange/terms/insPayment/payMode) 0-1</p>
payTerm	<p>code specifying the terms or time by which the payment must be done</p> <p>- base type: string, cod. table: T1</p> <p>http://www.ebiz.enea.it/moda-ml/repository/codelist/v2018-1/gc_T1.xml</p> <p>(XPath RAWSpinOrdChange/terms/insPayment/payTerm) 1-1</p> <p>(XPath RAWSpinOrdChange/terms/payment/payTerm) 1-1</p>
payTermText	<p>free text specifying the terms by which the payment must be done (time/mode or means)</p> <p>- base type: string, max length: 250,</p> <p>(XPath RAWSpinOrdChange/terms/insPayment/payTermText) 1-1 (U)</p> <p>(XPath RAWSpinOrdChange/terms/payment/payTermText) 1-1 (U)</p>
pcQty	<p>percent quantity of a raw material or of a specified component in a fabric or in a yarn</p> <p>- base type: decimal, min inclusive: 0, max inclusive: 100, fraction digits: 2,</p> <p>(XPath RAWSpinOrdChange/RSCXbody/RSCXitem/rawComponent/pcQty) 0-1</p>

pcTolerance	percent deviation tolerated on the value of a measurement (it must have a plus or minus sign) - base type: decimal, min inclusive: 0, max inclusive: 100, total digits: 2, (XPath RAWSpinOrdChange/RSCXbody/RSCXitem/yarnProd/yarnSpecs/pcTolerance) 0-2 (XPath RAWSpinOrdChange/RSCXbody/RSCXitem/yarnMnfrOperation/yarnMachineSpecs/pcTolerance) 0-2
percCompos	fiber rate in the product composition - base type: decimal, min inclusive: 0, max inclusive: 100, fraction digits: 2, (XPath RAWSpinOrdChange/RSCXbody/RSCXitem/yarnProd/yarnCompos/percCompos) 1-9
person	name of the contact person within a Party - base type: string, max length: 40, (XPath RAWSpinOrdChange/RSCXheader/buyer/person) 0-1 (XPath RAWSpinOrdChange/RSCXheader/thirdParty/person) 0-1 (XPath RAWSpinOrdChange/RSCXbody/RSCXitem/thirdParty/person) 0-1 (XPath RAWSpinOrdChange/RSCXheader/subContractor/person) 0-1
@phone	phone number of the contact person within a Party - base type: string, max length: 35, (XPath RAWSpinOrdChange/RSCXheader/buyer/person/@phone) [Optional] (XPath RAWSpinOrdChange/RSCXheader/thirdParty/person/@phone) [Optional] (XPath RAWSpinOrdChange/RSCXbody/RSCXitem/thirdParty/person/@phone) [Optional] (XPath RAWSpinOrdChange/RSCXheader/subContractor/person/@phone) [Optional]
postCode	code defining the postal zone - base type: string, max length: 10, (XPath RAWSpinOrdChange/RSCXheader/subContractor/postCode) 0-1 (XPath RAWSpinOrdChange/RSCXbody/RSCXitem/thirdParty/postCode) 0-1 (XPath RAWSpinOrdChange/RSCXheader/thirdParty/postCode) 0-1 (XPath RAWSpinOrdChange/RSCXheader/buyer/postCode) 0-1
price	unit price of the article, object or service specified - base type: decimal, min inclusive: 0, fraction digits: 4, (XPath RAWSpinOrdChange/RSCXbody/RSCXitem/price) 0-1 (AU)
@priceQualifier	type of price with reference to discount and taxes - base type: string, cod. table: NT20 http://www.ebiz.enea.it/moda-ml/repository/codelist/v2018-1/gc_NT20.xml (XPath RAWSpinOrdChange/RSCXbody/RSCXitem/price/@priceQualifier) [Optional] [Default= NET]
@progr	progressive number in the sequence - base type: positiveInteger, min inclusive: 1, (XPath RAWSpinOrdChange/terms/transInfo/@progr) [Optional] (N) - nota: <i>Indicates the position of the leg in a sequence of transport legs. If it is declared it must be in all the transInfo elements.</i>
qty	net quantity of the article or object correlated, qualified by the function of the document (ordering, delivering, ..) and by the context - base type: decimal, min inclusive: 0, fraction digits: 2, (XPath RAWSpinOrdChange/RSCXbody/RSCXitem/rawComponent/qty) 1-2 <hr/> AAAA-WARNING! - text not AVAILABLE n. 245 - In=en (XPath RAWSpinOrdChange/RSCXbody/RSCXitem/qty) 0-2 <hr/> AAAA-WARNING! - text not AVAILABLE n. 245 - In=en
rawJob	operation of a work cycle for raw material - base type: string, cod. table: T200 http://www.ebiz.enea.it/moda-ml/repository/codelist/v2018-1/gc_T200.xml (XPath RAWSpinOrdChange/RSCXbody/RSCXitem/rawMnfrOperation/rawJob) 1-1

@reelMat	<p>type of material of which a package for yarn is made</p> <p>- base type: string, cod. table: T30 http://www.ebiz.enea.it/moda-ml/repository/codelist/v2018-1/gc_T30.xml (XPath RAWSpinOrdChange/RSCXbody/RSCXitem/yarnProd/yarnPack/yarnReel/@reelMat) [Optional]</p>
@reelType	<p>type of package used for a yarn product</p> <p>- base type: string, cod. table: T29 http://www.ebiz.enea.it/moda-ml/repository/codelist/v2018-1/gc_T29.xml (XPath RAWSpinOrdChange/RSCXbody/RSCXitem/yarnProd/yarnPack/yarnReel/@reelType) [Required]</p>
@role	<p>Third Party role qualifier</p> <p>- base type: string, cod. table: NT2 http://www.ebiz.enea.it/moda-ml/repository/codelist/v2018-1/gc_NT2.xml (XPath RAWSpinOrdChange/RSCXbody/RSCXitem/thirdParty/@role) [Required] (XPath RAWSpinOrdChange/RSCXheader/thirdParty/@role) [Required]</p>
season	<p>sale season; defined as: season (1 crt) + year (4 crt) - season: S/S=1 A/W=2 Spring=3 Summer=4 Autumn=5 Winter=6: for more than four seasons use alphabetic sequence: 1st season=A 2nd season=B etc.etc.</p> <p>- base type: string, max length: 15, (XPath RAWSpinOrdChange/RSCXbody/RSCXitem/rawComponent/refDoc/season) 0-1 (A)</p> <p>- note: here indicates the season to which the referenced document belongs (XPath RAWSpinOrdChange/RSCXbody/RSCXitem/rawMnfrOperation/refDoc/season) 0-1 (A)</p> <p>- note: here indicates the season to which the referenced document belongs (XPath RAWSpinOrdChange/RSCXheader/season) 0-1 (A) (XPath RAWSpinOrdChange/RSCXheader/refDoc/season) 0-1 (A)</p> <p>- note: here indicates the season to which the referenced document belongs (XPath RAWSpinOrdChange/RSCXbody/RSCXitem/yarnProd/colorCardItem/refDoc/season) 0-1 (A)</p> <p>- note: here indicates the season to which the referenced document belongs (XPath RAWSpinOrdChange/RSCXbody/RSCXitem/yarnMnfrOperation/refDoc/season) 0-1 (A)</p> <p>- note: here indicates the season to which the referenced document belongs (XPath RAWSpinOrdChange/RSCXbody/RSCXitem/refDoc/season) 0-1 (A)</p> <p>- note: here indicates the season to which the referenced document belongs</p>
@sender	<p>qualifier that specifies the Party issuing of the document</p> <p>- base type: boolean, (XPath RAWSpinOrdChange/RSCXheader/subContractor/@sender) [Optional] (a*)</p> <p>- nota: This attribute is mandatory when the STYLESHEET must be used (XPath RAWSpinOrdChange/RSCXheader/thirdParty/@sender) [Optional] (a*)</p> <p>- nota: This attribute is mandatory when the STYLESHEET must be used (XPath RAWSpinOrdChange/RSCXheader/buyer/@sender) [Optional] (a*)</p> <p>- nota: This attribute is mandatory when the STYLESHEET must be used (XPath RAWSpinOrdChange/RSCXbody/RSCXitem/thirdParty/@sender) [Optional] (a*)</p> <p>- nota: This attribute is mandatory when the STYLESHEET must be used</p>
@source	<p>party who has provided the data</p> <p>- base type: string, cod. table: NT12 http://www.ebiz.enea.it/moda-ml/repository/codelist/v2018-1/gc_NT12.xml (XPath RAWSpinOrdChange/RSCXbody/RSCXitem/yarnProd/yarnSpecs/specValue/@source) [Optional] (XPath RAWSpinOrdChange/RSCXbody/RSCXitem/yarnMnfrOperation/yarnMachineSpecs/specValue/@source) [Optional]</p>
specValue	<p>value requested for a property or a parameter that is measured</p> <p>- base type: decimal, (XPath RAWSpinOrdChange/RSCXbody/RSCXitem/yarnProd/yarnSpecs/specValue) 0-1</p>

	(XPath RAWSpinOrdChange/RSCXbody/RSCXitem/yarnMnfrOperation/yarnMachineSpecs/specValue) 0-1
@standardObserver	CIE average chromatic response definition - base type: string, cod. table: T60 http://www.ebiz.enea.it/moda-ml/repository/codelist/v2018-1/gc_T60.xml (XPath RAWSpinOrdChange/RSCXbody/RSCXitem/yarnProd/colorCardItem/CIELab/@standardObserver) [Optional]
street	street and building number identifying a location - base type: string, max length: 80, (XPath RAWSpinOrdChange/RSCXbody/RSCXitem/thirdParty/street) 0-1 (XPath RAWSpinOrdChange/RSCXheader/buyer/street) 0-1 (XPath RAWSpinOrdChange/RSCXheader/subContractor/street) 0-1 (XPath RAWSpinOrdChange/RSCXheader/thirdParty/street) 0-1
subCountry	short name or code of the sub-country entity - base type: string, max length: 9, (XPath RAWSpinOrdChange/RSCXheader/subContractor/subCountry) 0-1 (XPath RAWSpinOrdChange/RSCXheader/buyer/subCountry) 0-1 (XPath RAWSpinOrdChange/RSCXbody/RSCXitem/thirdParty/subCountry) 0-1 (XPath RAWSpinOrdChange/RSCXheader/thirdParty/subCountry) 0-1
subDept	name or code of a contact department within a Party - base type: string, max length: 40, (XPath RAWSpinOrdChange/RSCXheader/subContractor/subDept) 0-1 (N) (XPath RAWSpinOrdChange/RSCXbody/RSCXitem/thirdParty/subDept) 0-1 (N) (XPath RAWSpinOrdChange/RSCXheader/thirdParty/subDept) 0-1 (N) (XPath RAWSpinOrdChange/RSCXheader/buyer/subDept) 0-1 (N)
taxCategory	duty or tax or fee category - base type: string, cod. table: T62 http://www.ebiz.enea.it/moda-ml/repository/codelist/v2018-1/gc_T62.xml (XPath RAWSpinOrdChange/terms/allowanceCharge/dtScheme/taxCategory) 0-1 (XPath RAWSpinOrdChange/RSCXbody/RSCXitem/dtScheme/taxCategory) 0-1
taxRate	duty or tax or fee percent rate - base type: string, (XPath RAWSpinOrdChange/terms/allowanceCharge/dtScheme/taxRate) 0-1 (XPath RAWSpinOrdChange/RSCXbody/RSCXitem/dtScheme/taxRate) 0-1
@taxType	duty or tax or fee type - base type: string, cod. table: T61 http://www.ebiz.enea.it/moda-ml/repository/codelist/v2018-1/gc_T61.xml (XPath RAWSpinOrdChange/terms/allowanceCharge/dtScheme/@taxType) [Required] (XPath RAWSpinOrdChange/RSCXbody/RSCXitem/dtScheme/@taxType) [Required]
tolerance	deviation tolerated on the value of a measurement (it must have a plus or minus sign) - base type: decimal, (XPath RAWSpinOrdChange/RSCXbody/RSCXitem/yarnMnfrOperation/yarnMachineSpecs/tolerance) 0-2 (XPath RAWSpinOrdChange/RSCXbody/RSCXitem/yarnProd/yarnSpecs/tolerance) 0-2
transCondition	special condition of transport or special service requested to the Forwarder - base type: string, cod. table: T38 http://www.ebiz.enea.it/moda-ml/repository/codelist/v2018-1/gc_T38.xml (XPath RAWSpinOrdChange/terms/transInfo/transCondition) 0-3
transConditionText	free text description of the special condition of transport or special service requested to the Forwarder - base type: string, max length: 250, (XPath RAWSpinOrdChange/terms/transInfo/transConditionText) 0-1 (U)

transMeans	<p>means of transport, in general or referred to a specific leg</p> <p>- base type: string, cod. table: T40</p> <p>http://www.ebiz.enea.it/moda-ml/repository/codelist/v2018-1/gc_T40.xml (XPath RAWSpinOrdChange/terms/transInfo/transMeans) 0-1</p>
transMode	<p>way of transport, in general or referred to the specified leg</p> <p>- base type: string, cod. table: T8</p> <p>http://www.ebiz.enea.it/moda-ml/repository/codelist/v2018-1/gc_T8.xml (XPath RAWSpinOrdChange/terms/transInfo/transMode) 1-1</p>
@transReason	<p>reason for the transport</p> <p>- base type: string, cod. table: NT11</p> <p>http://www.ebiz.enea.it/moda-ml/repository/codelist/v2018-1/gc_NT11.xml (XPath RAWSpinOrdChange/terms/transInfo/@transReason) [Optional]</p>
@uid	<p>unique element identifier within the xml document</p> <p>- base type: string,</p> <p>(XPath RAWSpinOrdChange/RSCXbody/RSCXitem/yarnProd/ colorCardItem/refDoc/attachment/@uid) [Optional]</p> <p>(XPath RAWSpinOrdChange/RSCXheader/refDoc/attachment/@uid) [Optional]</p> <p>(XPath RAWSpinOrdChange/RSCXbody/RSCXitem/rawComponent/ refDoc/attachment/@uid) [Optional]</p> <p>(XPath RAWSpinOrdChange/RSCXbody/RSCXitem/yarnMnfrOperation/refDoc/attac hment/@uid) [Optional]</p> <p>(XPath RAWSpinOrdChange/RSCXbody/RSCXitem/rawMnfrOperation/refDoc/attac hment/@uid) [Optional]</p> <p>(XPath RAWSpinOrdChange/RSCXbody/RSCXitem/refDoc/ attachment/@uid) [Optional]</p>
@um	<p>specification of the unit of measure</p> <p>- base type: string, cod. table: NT7</p> <p>http://www.ebiz.enea.it/moda-ml/repository/codelist/v2018-1/gc_NT7.xml (XPath RAWSpinOrdChange/RSCXbody/RSCXitem/yarnMnfrOperation/yarnMachin eSpecs/tolerance/@um) [Required]</p> <p>(XPath RAWSpinOrdChange/RSCXbody/RSCXitem/yarnProd/ yarnSpecs/tolerance/@um) [Required]</p> <p>(XPath RAWSpinOrdChange/RSCXbody/RSCXitem/yarnProd/ yarnPack/yarnReel/yarnReelH/@um) [Required]</p> <p>(XPath RAWSpinOrdChange/RSCXbody/RSCXitem/yarnProd/ yarnPack/yarnReel/yarnReelD/@um) [Required]</p> <p>(XPath RAWSpinOrdChange/RSCXbody/RSCXitem/yarnProd/ yarnPack/yarnReel/yarnReelQty/@um) [Required]</p> <p>(XPath RAWSpinOrdChange/RSCXbody/RSCXitem/yarnProd/ yarnSpecs/pcTolerance/@um) [Optional]</p> <p>- nota: <i>to be used when it has to be soecified if the declared percentage is b y weight, volume, etc...</i></p> <p>(XPath RAWSpinOrdChange/RSCXbody/RSCXitem/yarnMnfrOperation/yarnMachin eSpecs/specValue/@um) [Optional]</p> <p>(XPath RAWSpinOrdChange/RSCXbody/RSCXitem/rawComponent/ qty/@um) [Required]</p> <p>(XPath RAWSpinOrdChange/RSCXbody/RSCXitem/rawComponent/ pcQty/@um) [Optional]</p> <p>- nota: <i>to be used when it has to be soecified if the declared percentage is b y weight, volume, etc...</i></p> <p>(XPath RAWSpinOrdChange/terms/transInfo/grossWeight/@um) [Required]</p> <p>(XPath RAWSpinOrdChange/terms/allowanceCharge/@um) [Optional] (a)</p> <p>(XPath RAWSpinOrdChange/terms/transInfo/netWeight/@um) [Required]</p> <p>(XPath RAWSpinOrdChange/RSCXbody/RSCXitem/qty/@um) [Required]</p> <p>(XPath RAWSpinOrdChange/RSCXbody/RSCXitem/yarnProd/ yarnSpecs/specValue/@um) [Optional]</p> <p>(XPath RAWSpinOrdChange/RSCXbody/RSCXitem/yarnMnfrOperation/yarnMachin eSpecs/pcTolerance/@um) [Optional]</p>

	<p>- nota: <i>to be used when it has to be soecified if the declared percentage is b y weight, volume, etc...</i></p> <p>(XPath RAWSpinOrdChange/RSCXbody/RSCXitem/yarnProd/yarnSpecs/experimValue/@um) [Optional]</p> <p>(XPath RAWSpinOrdChange/RSCXbody/RSCXitem/price/@um) [Optional]</p> <p>- nota: <i>Unit of measure of the product to which the price is referred (price pe r meter)</i></p>
uri	<p>Uniform Resource Identifier (URI) that identifies the external object as an Internet resource</p> <p>- base type: normalizedString,</p> <p>(XPath RAWSpinOrdChange/RSCXbody/RSCXitem/yarnMnfrOperation/refDoc/attachment/externalReference/uri) 1-1 (N)</p> <p>(XPath RAWSpinOrdChange/RSCXbody/RSCXitem/yarnProd/colorCardItem/refDoc/attachment/externalReference/uri) 1-1 (N)</p> <p>(XPath RAWSpinOrdChange/RSCXbody/RSCXitem/refDoc/attachment/externalReference/uri) 1-1 (N)</p> <p>(XPath RAWSpinOrdChange/RSCXbody/RSCXitem/rawComponent/refDoc/attachment/externalReference/uri) 1-1 (N)</p> <p>(XPath RAWSpinOrdChange/RSCXheader/refDoc/attachment/externalReference/uri) 1-1 (N)</p> <p>(XPath RAWSpinOrdChange/RSCXbody/RSCXitem/rawMnfrOperation/refDoc/attachment/externalReference/uri) 1-1 (N)</p>
@useProfile	<p>use profile to which the present document if compliant if it was agreed by the parties. It is suggested a URI with reference to the firms or the URL of the profile.</p> <p>- base type: string,</p> <p>(XPath RAWSpinOrdChange/@useProfile) [Optional]</p>
@VAT	<p>VAT rate or code (DEPRECATED, use dtScheme element)</p> <p>- base type: string, cod. table: NT16</p> <p>http://www.ebiz.enea.it/moda-ml/repository/codelist/v2018-1/gc_NT16.xml</p> <p>(XPath RAWSpinOrdChange/RSCXheader/thirdParty/@VAT) [Optional]</p> <p>(XPath RAWSpinOrdChange/terms/allowanceCharge/@VAT) [Optional]</p> <p>(XPath RAWSpinOrdChange/RSCXbody/RSCXitem/lineN/@VAT) [Optional]</p> <p>- nota: <i>Deprecated, prefer dtScheme when available.</i></p> <p>(XPath RAWSpinOrdChange/RSCXbody/RSCXitem/thirdParty/@VAT) [Optional]</p>
@version	<p>Dictionary version from which the instance has been created</p> <p>- base type: string, cod. table: NT100</p> <p>http://www.ebiz.enea.it/moda-ml/repository/codelist/v2018-1/gc_NT100.xml</p> <p>(XPath RAWSpinOrdChange/@version) [Optional] [Default= 2018-1]</p>
yarnChar	<p>physical or mechanical parameter used to define a property of a yarn</p> <p>- base type: string, cod. table: T24</p> <p>http://www.ebiz.enea.it/moda-ml/repository/codelist/v2018-1/gc_T24.xml</p> <p>(XPath RAWSpinOrdChange/RSCXbody/RSCXitem/yarnProd/yarnSpecs/yarnChar) 1-1</p>
yarnCharText	<p>free text describing the physical or mechanical parameter used to define a property of a yarn</p> <p>- base type: string, max length: 250,</p> <p>(XPath RAWSpinOrdChange/RSCXbody/RSCXitem/yarnProd/yarnSpecs/yarnCharText) 1-1 (U)</p>
yarnConeAngle	<p>tapering angle of the cone on which a yarn is reeled</p> <p>- base type: positiveInteger,</p> <p>(XPath RAWSpinOrdChange/RSCXbody/RSCXitem/yarnProd/yarnPack/yarnReel/yarnConeAngle) 0-1</p>
yarnJob	<p>operation of a work cycle for yarn</p> <p>- base type: string, cod. table: T201</p> <p>http://www.ebiz.enea.it/moda-ml/repository/codelist/v2018-1/gc_T201.xml</p>

	(XPath RAWSpinOrdChange/RSCXbody/RSCXitem/yarnMnfrOperation/yarnJob) 1-1
yarnJobTech	operation technology for yarn - base type: string, cod. table: T261 http://www.ebiz.enea.it/moda-ml/repository/codelist/v2018-1/gc_T261.xml (XPath RAWSpinOrdChange/RSCXbody/RSCXitem/yarnMnfrOperation/yarnJobTech) 0-1
yarnMachine	machine used in an operation of a work cycle for yarn - base type: string, cod. table: T271 http://www.ebiz.enea.it/moda-ml/repository/codelist/v2018-1/gc_T271.xml (XPath RAWSpinOrdChange/RSCXbody/RSCXitem/yarnMnfrOperation/yarnMachine) 0-1
yarnMachineParam	setting parameter of a machine used in an operation of a work cycle for yarn - base type: string, cod. table: T281 http://www.ebiz.enea.it/moda-ml/repository/codelist/v2018-1/gc_T281.xml (XPath RAWSpinOrdChange/RSCXbody/RSCXitem/yarnMnfrOperation/yarnMachineSpecs/yarnMachineParam) 1-1
yarnOutWrap	code specifying the type of outer wrapping or packing of a yarn - base type: string, cod. table: T33 http://www.ebiz.enea.it/moda-ml/repository/codelist/v2018-1/gc_T33.xml (XPath RAWSpinOrdChange/RSCXbody/RSCXitem/yarnProd/yarnPack/yarnOutWrap) 0-1
yarnOutWrapText	free text specifying the type of outer wrapping or packing of a yarn - base type: string, max length: 250, (XPath RAWSpinOrdChange/RSCXbody/RSCXitem/yarnProd/yarnPack/yarnOutWrapText) 0-1 (U)
yarnReelD	diameter of the bobbin used for a yarn product - base type: decimal, min inclusive: 0, fraction digits: 2, (XPath RAWSpinOrdChange/RSCXbody/RSCXitem/yarnProd/yarnPack/yarnReel/yarnReelD) 0-1
yarnReelH	height of the bobbin used a yarn product - base type: decimal, min inclusive: 0, fraction digits: 2, (XPath RAWSpinOrdChange/RSCXbody/RSCXitem/yarnProd/yarnPack/yarnReel/yarnReelH) 0-1
yarnReelQty	quantity of yarn (by weight or length) wound upon a bobbin - base type: decimal, min inclusive: 0, fraction digits: 2, (XPath RAWSpinOrdChange/RSCXbody/RSCXitem/yarnProd/yarnPack/yarnReel/yarnReelQty) 0-2
yarnReelWrap	type of wrapping in which a package of yarn is wrapped - base type: string, cod. table: T32 http://www.ebiz.enea.it/moda-ml/repository/codelist/v2018-1/gc_T32.xml (XPath RAWSpinOrdChange/RSCXbody/RSCXitem/yarnProd/yarnPack/yarnInWrap/yarnReelWrap) 1-1

2.3 Suggested best practices

RAWSpinOrdChange/RSCXbody/RSCXitem/yarnMnfrOperation/refDoc/docID (identification number of the referenced document SINCE 2008-1 ITS USE IN THE HEADER IS DISCOURAGED (REPLACED BY msgID))

numberingOrg indicates the role that produced the document identifier (it is allowed to declare two different ones -e.g. customer and supplier - with two docID with different numberingOrg

RAWSpinOrdChange/RSCXbody/RSCXitem/rawComponent/

refDoc/docID (identification number of the referenced document SINCE 2008-1 ITS USE IN THE HEADER IS DISCOURAGED (REPLACED BY msgID))

numberingOrg indicates the role that produced the document identifier (it is allowed to declare two different ones -e.g. customer and supplier - with two docID with different numberingOrg

RAWSpinOrdChange/RSCXbody/RSCXitem/rawMnfrOperation/refDoc/docID (identification number of the referenced document SINCE 2008-1 ITS USE IN THE HEADER IS DISCOURAGED (REPLACED BY msgID))

numberingOrg indicates the role that produced the document identifier (it is allowed to declare two different ones -e.g. customer and supplier - with two docID with different numberingOrg

RAWSpinOrdChange/RSCXbody/RSCXitem/refDoc/docID (identification number of the referenced document SINCE 2008-1 ITS USE IN THE HEADER IS DISCOURAGED (REPLACED BY msgID))

numberingOrg indicates the role that produced the document identifier (it is allowed to declare two different ones -e.g. customer and supplier - with two docID with different numberingOrg

RAWSpinOrdChange/RSCXbody/RSCXitem/yarnProd/

colorCardItem/refDoc/docID (identification number of the referenced document SINCE 2008-1 ITS USE IN THE HEADER IS DISCOURAGED (REPLACED BY msgID))

numberingOrg indicates the role that produced the document identifier (it is allowed to declare two different ones -e.g. customer and supplier - with two docID with different numberingOrg

RAWSpinOrdChange/RSCXheader/refDoc/docID (identification number of the referenced document SINCE 2008-1 ITS USE IN THE HEADER IS DISCOURAGED (REPLACED BY msgID))

numberingOrg indicates the role that produced the document identifier (it is allowed to declare two different ones -e.g. customer and supplier - with two docID with different numberingOrg

RAWSpinOrdChange/RSCXheader/refDoc/attachment/

externalReference/mimeType (mime type of the external object)

Use coding from IANA <http://www.iana.org/assignments/media-types/media-types.xml>

RAWSpinOrdChange/RSCXbody/RSCXitem/rawComponent/

refDoc/attachment/externalReference/mimeType (mime type of the external object)

Use coding from IANA <http://www.iana.org/assignments/media-types/media-types.xml>

RAWSpinOrdChange/RSCXbody/RSCXitem/refDoc/

attachment/externalReference/mimeType (mime type of the external object)

Use coding from IANA <http://www.iana.org/assignments/media-types/media-types.xml>

RAWSpinOrdChange/RSCXbody/RSCXitem/rawMnfrOperation/refDoc/attachment/externalReference/mimeCode
(mime type of the external object)

Use coding from IANA <http://www.iana.org/assignments/media-types/media-types.xml>

RAWSpinOrdChange/RSCXbody/RSCXitem/yarnProd/
colorCardItem/refDoc/attachment/externalReference/mimeCode (mime type of the external object)

Use coding from IANA <http://www.iana.org/assignments/media-types/media-types.xml>

RAWSpinOrdChange/RSCXbody/RSCXitem/yarnMnfrOperation/refDoc/attachment/externalReference/mimeCode
(mime type of the external object)

Use coding from IANA <http://www.iana.org/assignments/media-types/media-types.xml>

RAWSpinOrdChange/RSCXbody/RSCXitem/rawComponent/qty (net quantity of the article or object correlated, qualified by the function of the document (ordering, delivering, ..) and by the context)

this element can have two instances only if the units of measure are different

RAWSpinOrdChange/RSCXbody/RSCXitem/qty (net quantity of the article or object correlated, qualified by the function of the document (ordering, delivering, ..) and by the context)

this element can have two instances only if the units of measure are different

2.4 Enumeration tables

List of enumeration tables used in the XML document. You can find the corresponding codes at:
<http://www.ebiz-tcf.eu/moda-ml/imple/moda-ml-2018-1.asp?lingua=en&pag=6>

Legenda

- N: new table
- U: updated properties

NT100 - eBIZ TCFUpstream version
NT11 - transport causal
NT12 - data source
NT16 - VAT rate or code
NT18 - message function
NT2 - third party qualifier
NT20 - price qualifier
NT29 - format of a date
NT3 - data format
NT37 - committed quantity qualifier
NT38 - colour test
NT5 - action code
NT6 - coding system owner/issuer
NT60 - language, codes from ISO 639-1 (subset) (N)
NT7 - unit of measure (U)
T1 - terms of payment
T10 - ISO3166 - Country
T19 - fibre type
T2 - Modes of payment
T200 - type of job on raw material
T201 - type of job on yarn
T21 - type of document
T24 - yarn characteristics type
T261 - type of job technology for yarn
T271 - machine type for yarn operation
T281 - parameter type for yarn operation
T29 - type of yarn package
T3 - terms of delivery
T30 - support of yarn package - material
T32 - yarn reel wrapping type
T33 - yarn outer packing
T38 - transport conditions
T40 - type of transport means
T41 - type of Allowance or Charge
T44 - additional code type
T59 - CIE illuminant
T60 - CIE standard observer
T61 - duty or tax or fee type
T62 - duty or tax or fee category
T8 - Modes of Transport
T9 - ISO4217 - Currency

Annex A

Representative images of the principal complex elements' structure.

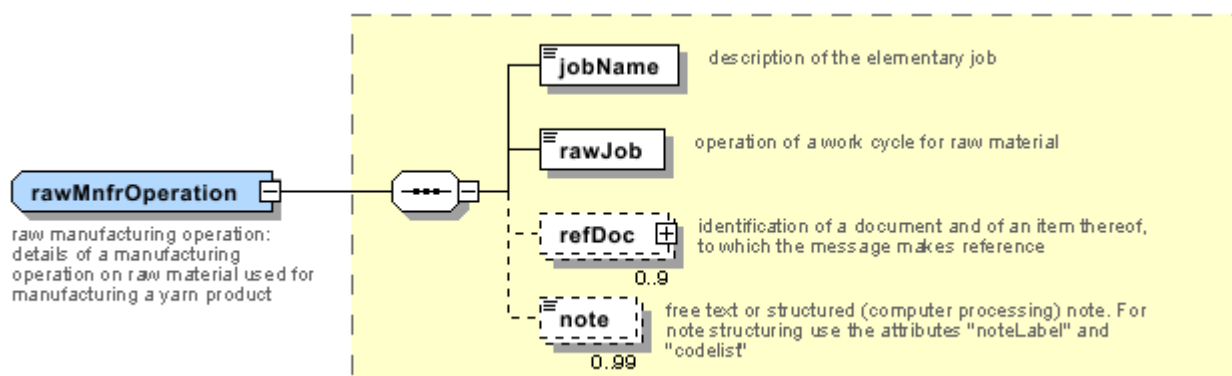
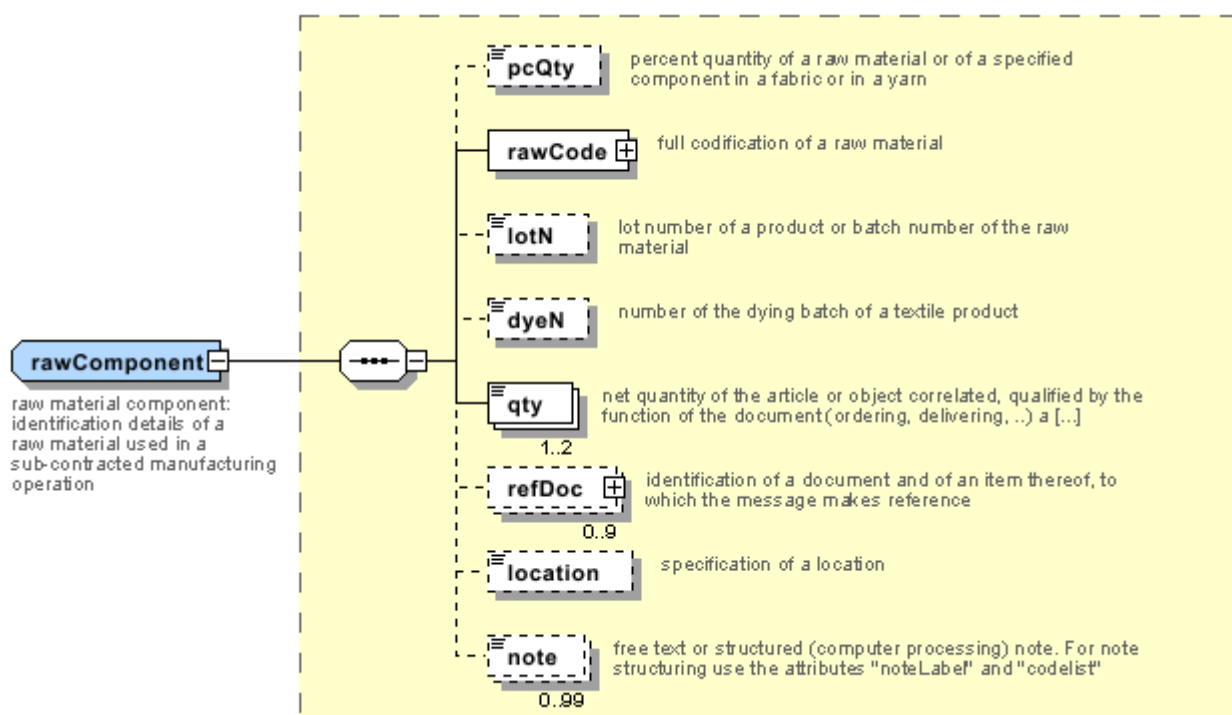
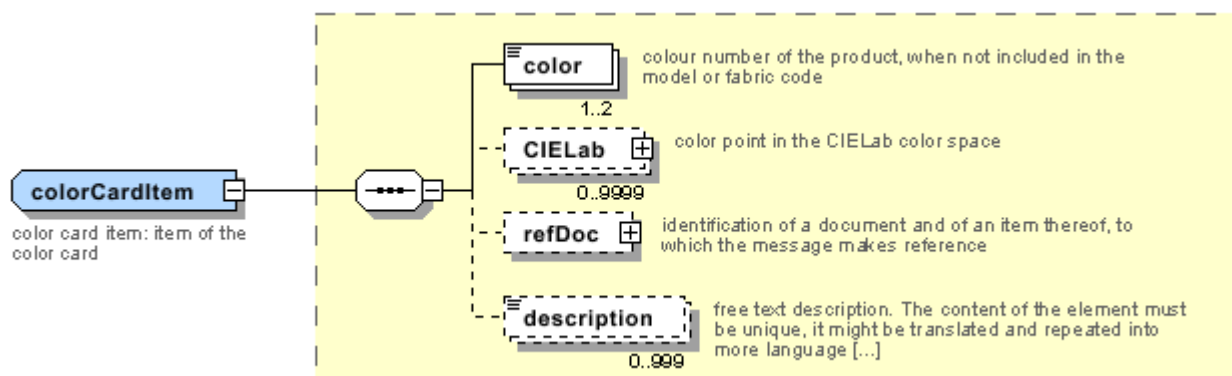

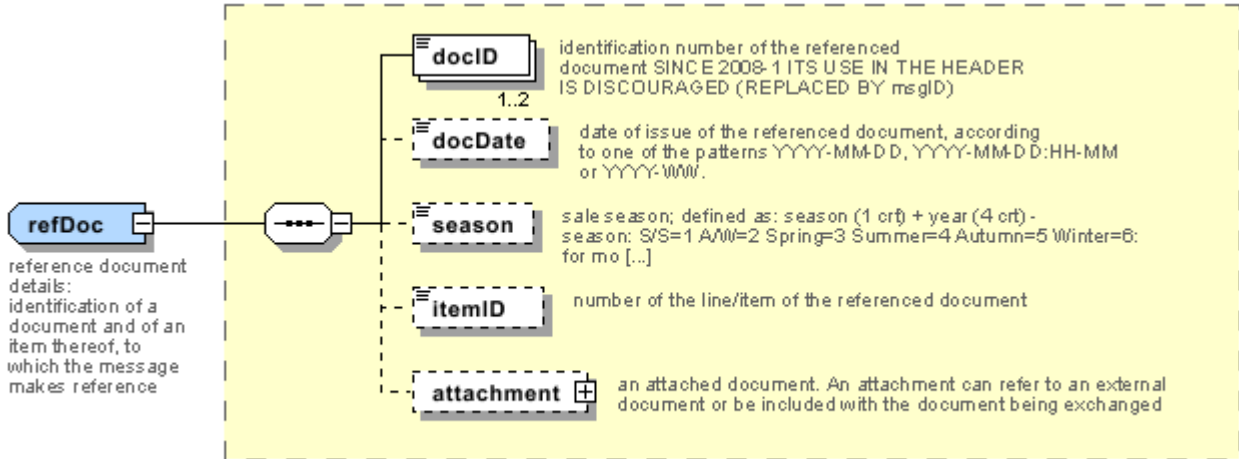
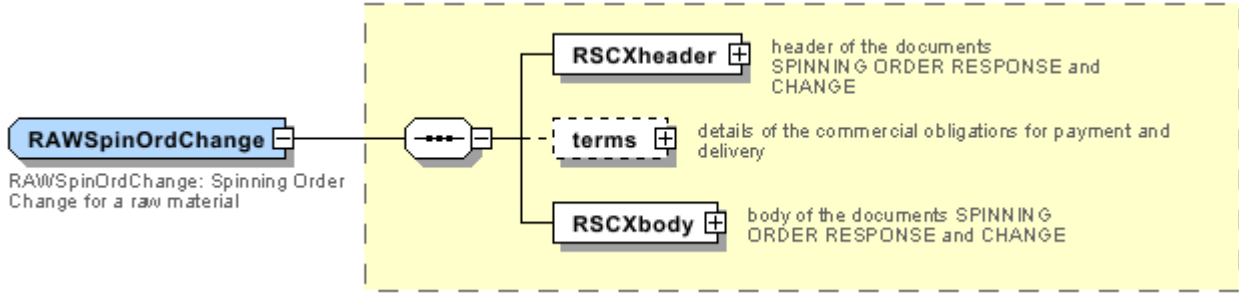

RSCXheader

RSCX header:
header of the
documents
SPINNING ORDER
RESPONSE and
CHANGE

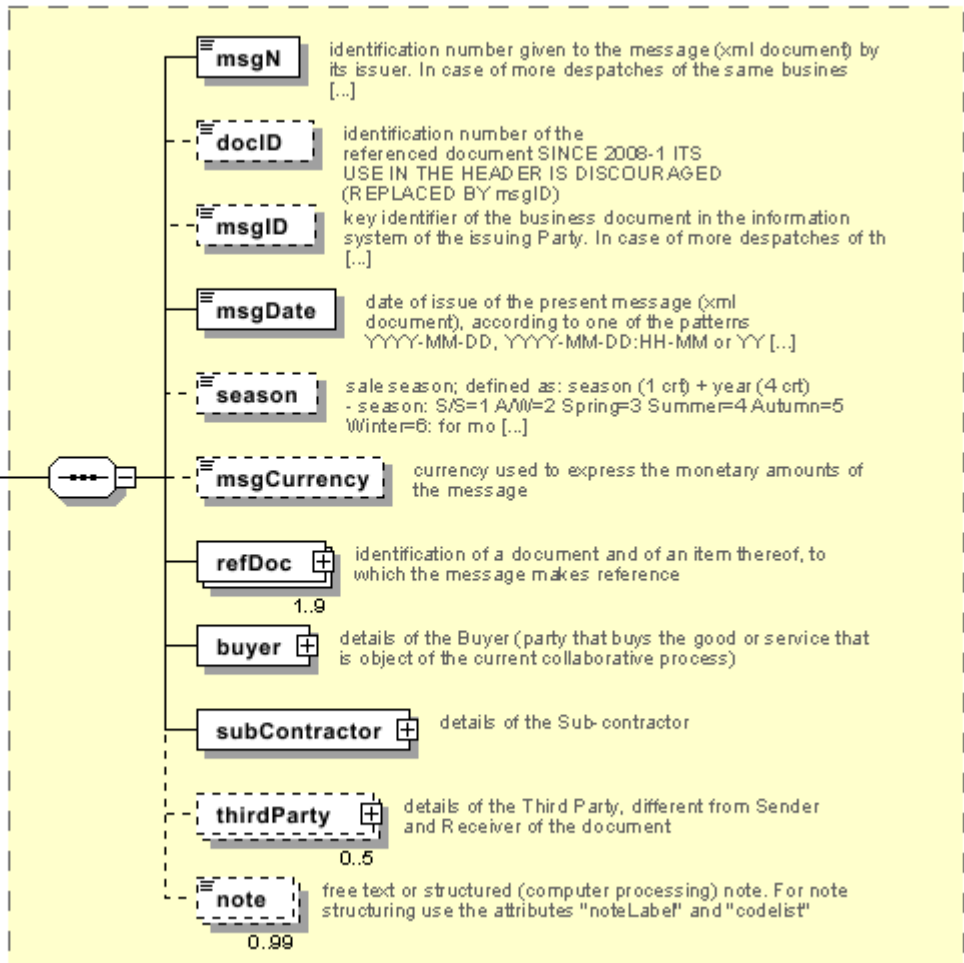

RSCXItem
 RSCX item:
 line of the
 documents
 SPINNING
 ORDER
 RESPONSE and
 CHANGE

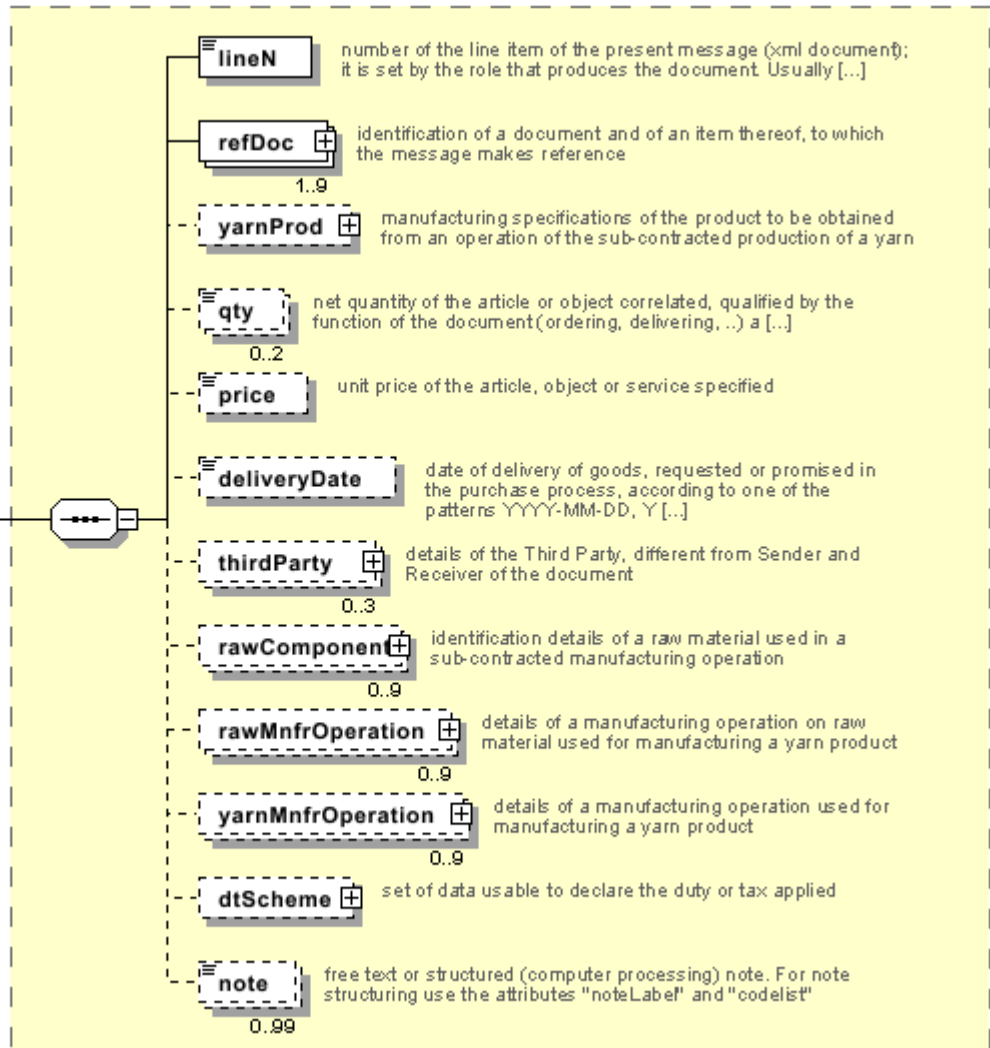

trade
 Trade details:
 general terms of
 trade for the
 specified supply

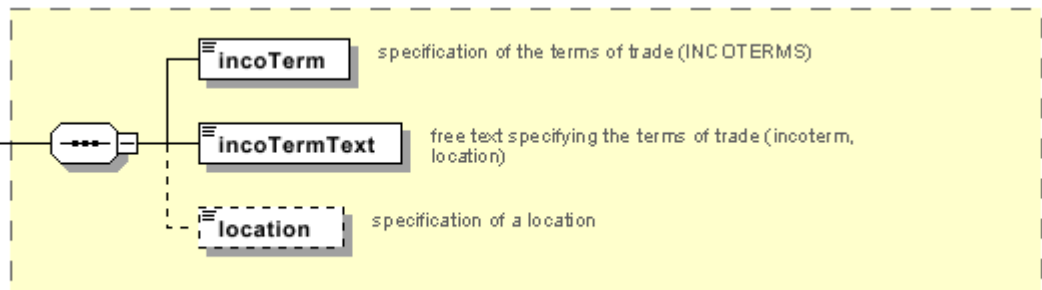

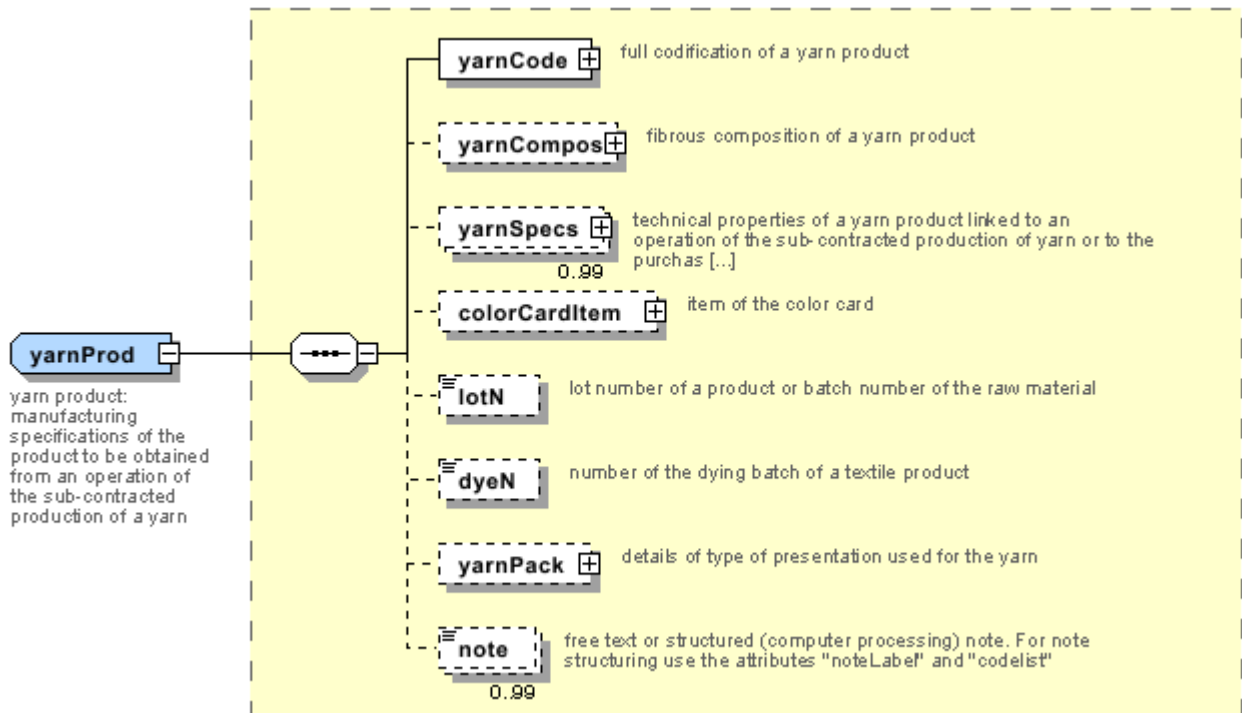

Annex B

NT100 - eBIZ TCFUpstream version

dictionary version

Agency name: eBIZ

tabella cod.: NT100

File codes list (Generic code): http://www.ebiz.enea.it/moda-ml/repository/codelist/v2018-1/gc_NT100.xml

Code	Description	Adoption note	Version status	Date of insertion
2013-1	v2013-1			01/07/2013
2018-1	v2018-1		(N)	04/11/2018
draft	draft		(N)	08/09/2017

NT11 - transport causal

reason for the transport

Agency name: eBIZ

tabella cod.: NT11

File codes list (Generic code): http://www.ebiz.enea.it/moda-ml/repository/codelist/v2018-1/gc_NT11.xml

Code	Description	Adoption note	Version status	Date of insertion
FOC	free of charge			
FRW	return from re-works			
FST	return from storage			
FWW	return from view			
FWK	return from works			
IST	in storage			
NWK	return non-worked			
RJC	return from rejection			
SEL	to sell			
STO	to storage			
VEW	to view			
WRK	to works			

NT12 - data source

party who has provided the data

Agency name: eBIZ

tabella cod.: NT12

File codes list (Generic code): http://www.ebiz.enea.it/moda-ml/repository/codelist/v2018-1/gc_NT12.xml

Code	Description	Adoption note	Version status	Date of insertion
AC	internal test			
CO	external test			
CV	test after steaming			

NT16 - VAT rate or code

VAT rate or code (DEPRECATED, use dtScheme element)

tabella cod.: NT16

File codes list (Generic code): http://www.ebiz.enea.it/moda-ml/repository/codelist/v2018-1/gc_NT16.xml

NT18 - message function

function performed by the present message with regards to the transmission

Agency name: eBIZ

tabella cod.: NT18

File codes list (Generic code): http://www.ebiz.enea.it/moda-ml/repository/codelist/v2018-1/gc_NT18.xml

Code	Description	Adoption note	Version status	Date of insertion
CA	delete this document			01/07/2013
CP	copy			
OR	original			
RC	re-transmission for data correction			
RT	re-transmission			

NT2 - third party qualifier

Third Party role qualifier

Agency name: eBIZ

tabella cod.: NT2

File codes list (Generic code): http://www.ebiz.enea.it/moda-ml/repository/codelist/v2018-1/gc_NT2.xml

Code	Description	Adoption note	Version status	Date of insertion
AG	Sales Agent			
AU	Auditor		(N)	08/04/2019
CE	Certification authority		(N)	08/04/2019
CO	Quality Controller			
DC	Response to			
DF	Invoicee			
DI	Copy to (CC)			28/10/2014
DM	Consignee			
DP	Consignment address (Delivery Party)			
IM	Importer			
OR	Originator			10/09/2014
SC	Sub contractor		(N)	10/04/2019
SM	Service/ePlatform manager		(N)	08/04/2019
SP	Forwarder			
TX	Tax Representative			

NT20 - price qualifier

type of price with reference to discount and taxes

Agency name: eBIZ

tabella cod.: NT20

File codes list (Generic code): http://www.ebiz.enea.it/moda-ml/repository/codelist/v2018-1/gc_NT20.xml

Code	Description	Adoption note	Version status	Date of insertion
GET	gross excluding taxes			
GIT	gross including taxes			
NET	net excluding taxes			
NIT	net including taxes			

NT29 - format of a date

format used for the date

Agency name: eBIZ

tabella cod.: NT29

File codes list (Generic code): http://www.ebiz.enea.it/moda-ml/repository/codelist/v2018-1/gc_NT29.xml

Code	Description	Adoption note	Version status	Date of insertion
D	YYYY-MM-DD			
M	YYYY-MM-DD:HH-MM			
W	YYYY-WW			

NT3 - data format

format of a string according to a customized User rule (local rule)

Agency name: eBIZ

tabella cod.: NT3

File codes list (Generic code): http://www.ebiz.enea.it/moda-ml/repository/codelist/v2018-1/gc_NT3.xml

Code	Description	Adoption note	Version status	Date of insertion
EN4	GS1-GLN			01/07/2013
MD	mutually agreed			

NT37 - committed quantity qualifier

specifies if the committed quantity can or can not include the loss in weight

Agency name: eBIZ

tabella cod.: NT37

File codes list (Generic code): http://www.ebiz.enea.it/moda-ml/repository/codelist/v2018-1/gc_NT37.xml

Code	Description	Adoption note	Version status	Date of insertion
NS	quantity can include losses			
SA	quantity can not include losses			

NT38 - colour test

specification of colour test before the operation

tabella cod.: NT38

File codes list (Generic code): http://www.ebiz.enea.it/moda-ml/repository/codelist/v2018-1/gc_NT38.xml

Code	Description	Adoption note	Version status	Date of insertion
1	only colour test			
2	with colour test			

NT5 - action code

action performed by the present line upon the referenced document line

Agency name: eBIZ

tabella cod.: NT5

File codes list (Generic code): http://www.ebiz.enea.it/moda-ml/repository/codelist/v2018-1/gc_NT5.xml

Code	Description	Adoption note	Version status	Date of insertion
A	CANCELLED			
C	CONFIRMED			
N	NEW ORDER LINE (created by an order change)			
R	PROVISIONAL CONFIRMATION			
S	DEFINITIVE CONFIRMATION			
SA	suspension accepted			
SN	suspension not accepted			
SR	suspension request			
V	AMENDED			

NT6 - coding system owner/issuer

code specifying the organisation who has created or owns the coding or numbering system

Agency name: eBIZ

tabella cod.: NT6

File codes list (Generic code): http://www.ebiz.enea.it/moda-ml/repository/codelist/v2018-1/gc_NT6.xml

Code	Description	Adoption note	Version status	Date of insertion
CL	Customer/buyer			
CO	Quality Controller			
EB	eBIZ	replaces 'ML'	(N)	18/03/2019
EN	GS1 (ex-EAN International)			
ES	e-Stockflow			

FO	Supplier			
GS	GS1			01/07/2013
MF	VAT identifier		(U)	
ML	Moda-ML	DEPRECATED	(U)	
SP	Service Provider			

NT60 - language, codes from ISO 639-1 (subset) (N)

Agency name: eBIZ / ISO

tabella cod.: NT60

File codes list (Generic code): http://www.ebiz.enea.it/moda-ml/repository/codelist/v2018-1/gc_NT60.xml

Code	Description	Adoption note	Version status	Date of insertion
af	Afrikaans		(N)	31/01/2019
ar	Arabic		(N)	31/01/2019
be	Belarusian		(N)	31/01/2019
bg	Bulgarian		(N)	31/01/2019
bn	Bengali		(N)	31/01/2019
bo	Tibetan		(N)	31/01/2019
bs	Bosnian		(N)	31/01/2019
ca	Catalan, Valencian		(N)	31/01/2019
cs	Czech		(N)	31/01/2019
da	Danish		(N)	31/01/2019
de	German		(N)	31/01/2019
el	Greek, Modern (1453-)		(N)	31/01/2019
en	English		(N)	31/01/2019
eo	Esperanto		(N)	31/01/2019
es	Spanish, Castilian		(N)	31/01/2019
et	Estonian		(N)	31/01/2019
eu	Basque		(N)	31/01/2019
F	Female		(N)	15/04/2019
fa	Persian		(N)	31/01/2019
fi	Finnish		(N)	31/01/2019
fr	French		(N)	31/01/2019
ga	Irish		(N)	31/01/2019
gd	Gaelic, Scottish Gaelic		(N)	31/01/2019

gn	Guarani		(N)	31/01/2019
he	Hebrew		(N)	31/01/2019
hr	Croatian		(N)	31/01/2019
ht	Haitian, Haitian Creole		(N)	31/01/2019
hu	Hungarian		(N)	31/01/2019
hy	Armenian		(N)	31/01/2019
ia	Interlingua (International Auxiliary Language Association)		(N)	31/01/2019
id	Indonesian		(N)	31/01/2019
is	Icelandic		(N)	31/01/2019
it	Italian		(N)	31/01/2019
ja	Japanese		(N)	31/01/2019
jv	Javanese		(N)	31/01/2019
ka	Georgian		(N)	31/01/2019
km	Central Khmer		(N)	31/01/2019
ko	Korean		(N)	31/01/2019
ku	Kurdish		(N)	31/01/2019
lb	Luxembourgish, Letzeburgesch		(N)	31/01/2019
lo	Lao		(N)	31/01/2019
lt	Lithuanian		(N)	31/01/2019
lv	Latvian		(N)	31/01/2019
mg	Malagasy		(N)	31/01/2019
mk	Macedonian		(N)	31/01/2019
mn	Mongolian		(N)	31/01/2019
mt	Maltese		(N)	31/01/2019
nl	Dutch, Flemish		(N)	31/01/2019
no	Norwegian		(N)	31/01/2019
pl	Polish		(N)	31/01/2019
pt	Portuguese		(N)	31/01/2019
ro	Romanian, Moldavian, Moldovan		(N)	31/01/2019
ru	Russian		(N)	31/01/2019
se	Northern Sami		(N)	31/01/2019
sk	Slovak		(N)	31/01/2019
sl	Slovenian		(N)	31/01/2019
sm	Samoan		(N)	31/01/2019
so	Somali		(N)	31/01/2019

sq	Albanian		(N)	31/01/2019
sr	Serbian		(N)	31/01/2019
sv	Swedish		(N)	31/01/2019
sw	Swahili		(N)	31/01/2019
ta	Tamil		(N)	31/01/2019
th	Thai		(N)	31/01/2019
tr	Turkish		(N)	31/01/2019
uk	Ukrainian		(N)	31/01/2019
ur	Urdu		(N)	31/01/2019
uz	Uzbek		(N)	31/01/2019
vi	Vietnamese		(N)	31/01/2019
zh	Chinese		(N)	31/01/2019

NT7 - unit of measure (U)

specification of the unit of measure, it is a sub set of table Unit of Measure Code - UN/ECE REC 20 delivered by United Nations Economic Commission for Europe (UN/ECE)

Agency name: eBIZ / UN/ECE

tabella cod.: NT7

File codes list (Generic code): http://www.ebiz.enea.it/moda-ml/repository/codelist/v2018-1/gc_NT7.xml

Other link: <http://docs.oasis-open.org/ubl/os-UBL-2.1/cl/gc/default/UnitOfMeasureCode-2.1.gc#>

Code	Description	Adoption note	Version status	Date of insertion
CMK	square centimetre		(N)	20/12/2017
CMQ	cubic centimetre		(N)	20/12/2017
CMT	centimetre			
CNE	centiNewton			
CO2TON	ton of CO2		(N)	10/09/2014
COUPLES	couples			
DMQ	cubic decimetre			
E37	pixel		(N)	11/04/2018
GRM	gram			
HUR	hour			
INH	inch			
KGM	kilogram			
KMT	kilometer			

KWH	kilowatthours		(N)	10/09/2014
LBR	pound			
MIN	minute			
MMK	square millimetre		(N)	20/12/2017
MTK	square metre		(N)	20/12/2017
MTQ	cubic metre			
MTR	metre			
NMB	numero			
ONZ	ounce			
P1	percent			
PPM	parts per milion			
PZ	piece		(U)	
RPM	rounds per metre			
YRD	yard			

T1 - terms of payment

code specifying the terms or time by which the payment must be done

Agency name: eBIZ

tabella cod.: T1

File codes list (Generic code): http://www.ebiz.enea.it/moda-ml/repository/codelist/v2018-1/gc_T1.xml

Code	Description	Adoption note	Version status	Date of insertion
ANTICIP	PAYMENT IN ADVANCE			
BLCOLLECT/120D	BILL OF LADING 120 DD			
BLCOLLECT/30D	BILL OF LADING 30 DD			
BLCOLLECT/60D	BILL OF LADING 60 DD			
BLCOLLECT/90D	BILL OF LADING 90 DD			
CASH	PAYMENT ON DELIVERY			
CASHINV	PAYMENT ON RECEIPT OF INVOICE			
CREDOC/0D	DOCUMENTARY CREDIT FOR PAYM. AT SIGHT			
CREDOC/120	DOCUMENTARY CREDIT FOR PAYM. AT 120 DD			
CREDOC/150	DOCUMENTARY CREDIT FOR PAYM. AT 150 DD			
CREDOC/180	DOCUMENTARY CREDIT FOR PAYM. AT 180 DD			

CREDOC/30D	DOCUMENTARY CREDIT FOR PAYM. AT 30 DD			
CREDOC/45D	DOCUMENTARY CREDIT FOR PAYM. AT 45 DD			
CREDOC/60	DOCUMENTARY CREDIT FOR PAYM. AT 60 DD			
CREDOC/90	DOCUMENTARY CREDIT FOR PAYM. AT 90 DD			
DEL/10	PAYMENT AT 10 DD AFTER DELIVERY			
DOCOLLECT/120D	DOCUMENTARY COLLECTION AT 120 DD			
DOCOLLECT/30D	DOCUMENTARY COLLECTION AT 30 DD			
DOCOLLECT/60D	DOCUMENTARY COLLECTION AT 60 DD			
DOCOLLECT/90D	DOCUMENTARY COLLECTION AT 90 DD			
INV/120D	PAYMENT AT 120 DD AFTER RECEIPT OF INVOICE			
INV/150D	PAYMENT AT 150 DD AFTER RECEIPT OF INVOICE			
INV/180D	PAYMENT AT 180 DD AFTER RECEIPT OF INVOICE			
INV/30D	PAYMENT AT 30 DD AFTER RECEIPT OF INVOICE			
INV/45D	PAYMENT AT 45 DD AFTER RECEIPT OF INVOICE			
INV/60D	PAYMENT AT 60 DD AFTER RECEIPT OF INVOICE			
INV/90D	PAYMENT AT 90 DD AFTER RECEIPT OF INVOICE			
INVULTIMO	PAYMENT AT END MONTH RECEIPT INVOICE			
INVULTIMO/10D	PAYMENT 10 DD AFTER END MONTH RECEIPT INVOICE			
INVULTIMO/120D	PAYMENT 120 DD AFTER END MONTH RECEIPT INVOICE			
INVULTIMO/150D	PAYMENT 150 DD AFTER END MONTH RECEIPT INVOICE			
INVULTIMO/180D	PAYMENT 180 DD AFTER END MONTH RECEIPT INVOICE			
INVULTIMO/240D	PAYMENT 240 DD AFTER END MONTH RECEIPT INVOICE			
INVULTIMO/30D	PAYMENT 30 DD AFTER END MONTH RECEIPT INVOICE			
INVULTIMO/45D	PAYMENT 45 DD AFTER END MONTH RECEIPT INVOICE			
INVULTIMO/60D	PAYMENT 60 DD AFTER END MONTH RECEIPT INVOICE			
INVULTIMO/90D	PAYMENT 90 DD AFTER END MONTH RECEIPT INVOICE			
NOPAY	WITHOUT PAYMENT			

RECREDOC/0D	IRREVOC. DOCUMENTARY CREDIT FOR PAYM. AT SIGHT			
RECREDOC/120D	IRREVOC. DOCUMENTARY CREDIT FOR PAYM. AT 120 DD			
RECREDOC/150D	IRREVOC. DOCUMENTARY CREDIT FOR PAYM. AT 150 DD			
RECREDOC/180D	IRREVOC. DOCUMENTARY CREDIT FOR PAYM. AT 180 DD			
RECREDOC/30D	IRREVOC. DOCUMENTARY CREDIT FOR PAYM. AT 30 DD			
RECREDOC/45D	IRREVOC. DOCUMENTARY CREDIT FOR PAYM. AT 45 DD			
RECREDOC/60D	IRREVOC. DOCUMENTARY CREDIT FOR PAYM. AT 60 DD			
RECREDOC/90D	IRREVOC. DOCUMENTARY CREDIT FOR PAYM. AT 90 DD			
ULTIMO	PAYMENT BY END MONTH OF DELIVERY			
ULTIMO/10	PAYMENT AT 10 DD AFTER END MONTH OF DELIVERY			

T10 - ISO3166 - Country

code of the nation

Agency name: ISO

tabella cod.: T10

File codes list (Generic code): http://www.ebiz.enea.it/moda-ml/repository/codelist/v2018-1/gc_T10.xml

Table not printed: there are 239 elements, more than the maximum specified for printing: 99.

T19 - fibre type

type of fibre used in a textile product

Agency name: eBIZ

tabella cod.: T19

File codes list (Generic code): http://www.ebiz.enea.it/moda-ml/repository/codelist/v2018-1/gc_T19.xml

Code	Description	Adoption note	Version status	Date of insertion
AB	abaca			20/08/2018
AC	acetate			
AF	other fibres			

AG	alginic fibre			
AL	alfa			20/08/2018
CA	hemp			
CC	coir (coconut)			20/08/2018
CL	chlorofibre			
CO	cotton			
CU	cuprous			
EA	elastan			
EL	Elastodiene			20/08/2018
FL	fluorofibre			
GI	broom			20/08/2018
GL	textile glass			
HA	hair			20/08/2018
HE	henequen			20/08/2018
HL	mixed linen			
HL	cotton linen union			20/08/2018
JU	jute			
KE	kenaf			20/08/2018
KP	kapoc			20/08/2018
LI	linen			
LY	lyocell			20/08/2018
MA	modacrylic			
MD	modal			
ME	metallized			
MG	maguey			20/08/2018
PA	polyamide			
PB	polyureic			
PC	acrylic			
PE	polyethylene			
PI	paper			20/08/2018
PL	polyester			
PM	polyimide			
PP	polypropylene			
PR	proteic			
PU	polyurethane			

RA	mamie			20/08/2018
SE	silk			
SI	sisal			20/08/2018
SN	sun			20/08/2018
TA	triacetate			
TR	textile residues or unspecified composition			20/08/2018
TV	trivinyll			
VI	viscose			
VY	vinylal			
WA	angora			
WB	beaver			20/08/2018
WC	cashgora			
WG	vicuna			
WK	camel			
WL	llama			
WM	mohair			
WN	lapin			20/08/2018
WO	wool			
WP	alpaca			
WS	cashmere			
WT	Oteer			20/08/2018
WU	guanaco			
WV	virgin wool			
WY	yack			

T2 - Modes of payment

way or means of payment

Agency name: eBIZ

tabella cod.: T2

File codes list (Generic code): http://www.ebiz.enea.it/moda-ml/repository/codelist/v2018-1/gc_T2.xml

Code	Description	Adoption note	Version status	Date of insertion
BB	bank transfer			
IA	collection through Agent			
IS	collection through Forwarder			

RB	bank receipt			
RD	remittance			
SW	bank SWIFT			
TR	bank draft			

T200 - type of job on raw material

operation of a work cycle for raw material

Agency name: eBIZ

tabella cod.: T200

File codes list (Generic code): http://www.ebiz.enea.it/moda-ml/repository/codelist/v2018-1/gc_T200.xml

Code	Description	Adoption note	Version status	Date of insertion
01	dejarrare			
02	to wash			
03	to dry			
04	to mix			
05	to comb			
06	to cut			
07	to tear open			
08	to beat			
09	to carbonise			
10	to dye			
11	felting			
12	to smoothen			
13	vigoreux			
14	angra			
15	basolan			
16	unshrinkable			
17	to blend			

T201 - type of job on yarn

operation of a work cycle for yarn

Agency name: eBIZ

tabella cod.: T201

File codes list (Generic code): http://www.ebiz.enea.it/moda-ml/repository/codelist/v2018-1/gc_T201.xml

Code	Description	Adoption note	Version status	Date of insertion
08	to re-comb			
09	to prepare			
10	to card			
11	to spin			
12	to steam			
13	to wind			
14	doubling			
15	to twist			
16	to unwind			
17	to singe			
18	to raise			
19	to reel			
20	to re-wind			
21	to shrink			
22	to coat			
23	to garnett			
24	to print			
25	to dye			
26	to boil			
27	to scour			
28	to dry			
99	other, see note if any			01/07/2013

T21 - type of document

type or class to which the referenced document belongs

Agency name: eBIZ

tabella cod.: T21

File codes list (Generic code): http://www.ebiz.enea.it/moda-ml/repository/codelist/v2018-1/gc_T21.xml

Code	Description	Adoption note	Version status	Date of insertion
BOR	blanket order		(N)	01/02/2018

CAT	Price catalogue - tech sheet			
CEO	Certificate of origin		(N)	13/04/2018
CER	Certificate		(N)	13/04/2018
COC	colour card			
CRN	Credit note			08/09/2017
CTO	Checking order			01/07/2013
CTR	Contract		(U)	
CXF	CxF3 file			01/07/2013
DAD	Darn order			
DDT	ddt			
DEA	Despatch advise			
DER	Despatch request			
DR	Document Request			02/12/2014
FOR	Forecast			02/12/2014
GSO	Garment stock offer			
GSX	Garment stock offer change			
INV	Invoice			
KCC	Knitting-Clothing Commission Order			02/12/2014
KCI	Garment in Work Inventory Report			02/12/2014
M2M	Made to Measure Production Order			02/12/2014
MAS	Master marker			
MCI	Visual merchandising instruction		(N)	13/04/2018
OCH	Order change			
OFF	Offer			
ORD	Purchase order			
ORP	Order response			
OSR	order status request			
OSS	Offer status			02/12/2014
OST	Order status			
OUR	our reference			
QR	Quality Report			02/12/2014
RAI	Raw Material in Work Inventory Report			02/12/2014
RDC	Raw dyeing commission order			
RDH	Raw dyeing order change			
RDR	Raw dyeing order response			

REA	Receiving advise			
REQ	Request for Offer			
RET	Return			02/12/2014
RSC	Spinning commission order			
RSH	Spinning order change			
RSR	Spinning order response			
SCL	process sheet			
TFC	Textile dyeing-finishing commission order			
TFX	Textile Dyeing-Finishing Order Change			02/12/2014
TPC	Textile printing commission order			
TPX	Textile Printing Order Change			02/12/2014
TWI	Textile in work inventory			
VMI	visual merchandising instructions		(N)	01/02/2018
WAC	Warping commission order			
WEC	Weaving commission order			
YDC	Yarn dyeing commission order			
YDH	Yarn dyeing order change			
YDR	Yarn dyeing order response			
YTC	Twisting commission order			
YWI	Yarn in work inventory			

T24 - yarn characteristics type

physical or mechanical parameter used to define a property of a yarn

Agency name: eBIZ

tabella cod.: T24

File codes list (Generic code): http://www.ebiz.enea.it/moda-ml/repository/codelist/v2018-1/gc_T24.xml

Code	Description	Adoption note	Version status	Date of insertion
ALL	elongation			
AMIN	minimum yarn elongation			
CV	CV			
DE	delta E			
NFIN	number of cases diameter less than X%			
NGRO	number of cases diameter greater than X%			
NOD	standard nub			

NOS	Splicer nub			
PLH	H hairiness			
PLL	pilling			
RES	tensile strength			
RMIN	minimum tensile strength			
RTR	shrinkage			
SLA	fastness to light (ISO 105-B02)			
SLB	fastness to water washing (ISO 105-C06)			
SLC	fastness to dry washing (ISO 105-D01)			
SLD	fastness to water drop (ISO 105-E07)			
SLW	fastness to water (ISO 105-E01)			
SLX	fastness to Xeno light (ISO 105-E01)			
STW	S-twist			
TIN	english count			
TMT	metric count			
TTX	tex count			
ZTW	Z-twist			

T261 - type of job technology for yarn

operation technology for yarn

Agency name: eBIZ

tabella cod.: T261

File codes list (Generic code): http://www.ebiz.enea.it/moda-ml/repository/codelist/v2018-1/gc_T261.xml

Code	Description	Adoption note	Version status	Date of insertion
01	standard spinning			
02	spinning frames			
03	compact spinning			
04	pims winding			
05	cones winding			
06	package dyeing			
07	hank dyeing			
08				
09	reactive dyeing			
10	direct dyeing			

11	natural dyeing			
12	heat sensitive dyeing			
13	light sensitive dyeing			
14	pigments dyeing			
15	shaded dyeing			
16	tye and dye			
17				
18				
19				
20	acid dyeing			
21	pre-metallized dyeing			
22				
23	basic dyeing			
99	other, see note if any			01/07/2013

T271 - machine type for yarn operation

machine used in an operation of a work cycle for yarn

Agency name: eBIZ

tabella cod.: T271

File codes list (Generic code): http://www.ebiz.enea.it/moda-ml/repository/codelist/v2018-1/gc_T271.xml

Code	Description	Adoption note	Version status	Date of insertion
01	RIETER			
02	ZINZER			
03	MURATA			
04	SAVIO			
05	TEXILMONTAGGIO			
06	BIGAGLI			
07	GALAN			
08	GAUDINO			
99	other, see note if any			01/07/2013

T281 - parameter type for yarn operation

setting parameter of a machine used in an operation of a work cycle for yarn

Agency name: eBIZ

tabella cod.: T281

File codes list (Generic code): http://www.ebiz.enea.it/moda-ml/repository/codelist/v2018-1/gc_T281.xml

Code	Description	Adoption note	Version status	Date of insertion
01	ring diameter			
02	package weight			
03	yarn clearance			

T29 - type of yarn package

type of package (roll-up) used for a yarn product

Agency name: eBIZ

tabella cod.: T29

File codes list (Generic code): http://www.ebiz.enea.it/moda-ml/repository/codelist/v2018-1/gc_T29.xml

Code	Description	Adoption note	Version status	Date of insertion
CIL	bobbin			
CON	cone			
HNK	hank, skein			01/07/2013
MUF	muff, cake			01/07/2013
SPL	spool			
TUB	tube			
XCO	supercone			

T3 - terms of delivery

specification of the terms of trade (INCOTERMS)

Agency name: Incoterms

tabella cod.: T3

File codes list (Generic code): http://www.ebiz.enea.it/moda-ml/repository/codelist/v2018-1/gc_T3.xml

Code	Description	Adoption note	Version status	Date of insertion
CFR	COST AND FREIGHT (named port of destination)			

CIF	COST, INSURANCE AND FREIGHT (named port of destination)			
CIP	CARRIAGE AND INSURANCE PAID (named place of destination)			
CP T	CARRIAGE PAID (named place of destination)			
DA F	DELIVERED AT FRONTIER (named place)	according to Incoterms® 2010 it is obsolete		08/12/2017
DA P	Delivered at Place of destination (named place of destination)	according to Incoterms® 2010		08/12/2017
DA T	Delivered at Terminal (named place of destination)	according to Incoterms® 2010		08/12/2017
DD P	DELIVERED DUTY PAID (named place of destination)			
DD U	DELIVERED DUTY UNPAID (named place of destination)	according to Incoterms® 2010 it is obsolete, use DAP		08/12/2017
DE Q	DELIVERED EX-QUAY (named port of destination)	according to Incoterms® 2010 it is obsolete		08/12/2017
DE S	DELIVERED EX-SHIP (named port of destination)	according to Incoterms® 2010 it is obsolete		08/12/2017
EX W	EX WORKS (named place)			
FA S	FREE ALONGSIDE SHIP (named port of shipment)			
FC A	FREE CARRIER (named place)			
FO B	FREE ON BOARD (named port of shipment)			

T30 - support of yarn package - material

type of material of which a package for yarn is made

Agency name: eBIZ

tabella cod.: T30

File codes list (Generic code): http://www.ebiz.enea.it/moda-ml/repository/codelist/v2018-1/gc_T30.xml

Code	Description	Adoption note	Version status	Date of insertion
CA	cartoon			
DY	for soft package dyeing			
MT	metallic			01/07/2013
PL	plastic			

T32 - yarn reel wrapping type

type of wrapping in which a package of yarn is wrapped

Agency name: eBIZ

tabella cod.: T32

File codes list (Generic code): http://www.ebiz.enea.it/moda-ml/repository/codelist/v2018-1/gc_T32.xml

Code	Description	Adoption note	Version status	Date of insertion
XA	without bag			
XB	paper bag			01/07/2013
XD	plastic film bag			

T33 - yarn outer packing

code specifying the type of outer wrapping or packing of a yarn

Agency name: eBIZ

tabella cod.: T33

File codes list (Generic code): http://www.ebiz.enea.it/moda-ml/repository/codelist/v2018-1/gc_T33.xml

Code	Description	Adoption note	Version status	Date of insertion
00				
CB	cartoon box			
CC	cartoon box 18 reels			
CD	cartoon box 36 reels			
XD	plastic film			

T38 - transport conditions

special condition of transport or special service requested to the Forwarder

tabella cod.: T38

File codes list (Generic code): http://www.ebiz.enea.it/moda-ml/repository/codelist/v2018-1/gc_T38.xml

Code	Description	Adoption note	Version status	Date of insertion
ACC	arrange customs clearance			
CAL	Carrier loads			

CAU	Carrier unloads			
CMR	CMR carnet			
FFN	freight forwarders national conditions			
FLD	special agreement for full loading			
NCC	do not arrange customs clearance			
PPB	packaging paid by Buyer			
PPS	packaging paid by Supplier			
PRO	proof of delivery			
RFR	return container free			
RPC	return container paid by Customer			
RPS	return container paid by Supplier			
SHL	Shipper loads			
SHU	Consignee unloads			

T40 - type of transport means

means of transport, in general or referred to a specific leg

Agency name: eBIZ

tabella cod.: T40

File codes list (Generic code): http://www.ebiz.enea.it/moda-ml/repository/codelist/v2018-1/gc_T40.xml

Code	Description	Adoption note	Version status	Date of insertion
AIR	aircraft			
SHP	ship			
TRU	truck			
VAN	van			

T41 - type of Allowance or Charge

coded specification of an Allowance or Charge (elaborated from UNECE 4465)

Agency name: eBIZ

tabella cod.: T41

File codes list (Generic code): http://www.ebiz.enea.it/moda-ml/repository/codelist/v2018-1/gc_T41.xml

Code	Description	Adoption note	Version status	Date of insertion

1	Agreed settlement		(N)	19/08/2018
10	Costs for draft		(N)	19/08/2018
11	Bank charges	DEPRECATED, use CBK	(N)	19/08/2018
12	Agent commission		(N)	19/08/2018
14	Wrong delivery		(N)	19/08/2018
15	Goods returned to agent		(N)	19/08/2018
16	Goods partly returned		(N)	19/08/2018
17	Transport damage		(N)	19/08/2018
19	Trade discount		(N)	19/08/2018
2	Below specification goods		(N)	19/08/2018
20	Deduction for late delivery	DEPRECATED, use CWB	(N)	19/08/2018
21	Advertising costs		(N)	19/08/2018
22	Customs duties		(N)	19/08/2018
23	Telephone and postal costs		(N)	19/08/2018
24	Repair costs		(N)	19/08/2018
25	Attorney fees		(N)	19/08/2018
26	Taxes		(N)	19/08/2018
3	Damaged goods		(N)	19/08/2018
30	Direct payment to seller		(N)	19/08/2018
32	Goods not delivered		(N)	19/08/2018
33	Late delivery		(N)	19/08/2018
35	Goods returned		(N)	19/08/2018

36	Invoice not received		(N)	19/08/2018
37	Credit note to debtor/not to us		(N)	19/08/2018
38	Deducted bonus		(N)	19/08/2018
39	Deducted discount		(N)	19/08/2018
4	Short delivery		(N)	19/08/2018
40	Deducted freight costs		(N)	19/08/2018
41	Deduction against other invoices		(N)	19/08/2018
42	Credit balance(s)		(N)	19/08/2018
45	Debit note to seller		(N)	19/08/2018
46	Discount beyond terms		(N)	19/08/2018
48	Allowance/charge error		(N)	19/08/2018
49	Substitute product		(N)	19/08/2018
50	Terms of sale error		(N)	19/08/2018
52	Wrong invoice		(N)	19/08/2018
53	Duplicate invoice		(N)	19/08/2018
54	Weight error		(N)	19/08/2018
55	Additional charge not authorized		(N)	19/08/2018
56	Incorrect discount		(N)	19/08/2018
57	Price change		(N)	19/08/2018
58	Variation		(N)	19/08/2018
59	Chargeback		(N)	19/08/2018
65	Settlement to agent		(N)	19/08/2018

66	Cash discount		(N)	19/08/2018
7	Payment on account		(N)	19/08/2018
70	Wrong monetary amount resulting from incorrect free goods quantity		(N)	19/08/2018
72	Temporary special promotion		(N)	19/08/2018
73	Difference in tax rate		(N)	19/08/2018
74	Quantity discount		(N)	19/08/2018
75	Promotion discount		(N)	19/08/2018
76	Cancellation deadline passed		(N)	19/08/2018
77	Pricing discount		(N)	19/08/2018
78	Volume discount		(N)	19/08/2018
79	Sundry discount		(N)	19/08/2018
8	Returnable container charge included		(N)	19/08/2018
9	Invoice error		(N)	19/08/2018
AWA	bonus for works ahead of schedule			
CBK	bank charges			
CCR	servizio di corriere			
CIN	insurance			
CLB	labelling			
CPK	packing			
CSP	special packing			
CWB	penalty for works behind schedule			

T44 - additional code type

qualifier of the additional coding of a product

Agency name: eBIZ

tabella cod.: T44

File codes list (Generic code): http://www.ebiz.enea.it/moda-ml/repository/codelist/v2018-1/gc_T44.xml

Code	Description	Adoption note	Version status	Date of insertion
CC	colour card			
CL	sales collection			
CO	company identification code		(N)	08/09/2017
DY	dye number			
LT	lot number			
MDI	Made in			08/09/2017
MS	manufacturing state			
PKG	packaging			09/09/2014
PL	product line			
RGB	RGB value			
SE	selvedge code			

T59 - CIE illuminant

CIE light source

tabella cod.: T59

File codes list (Generic code): http://www.ebiz.enea.it/moda-ml/repository/codelist/v2018-1/gc_T59.xml

Code	Description	Adoption note	Version status	Date of insertion
A	home tungsten CCT 2856K°			01/07/2013
C	daylight CCT 6774K°			01/07/2013
D50	daylight CCT 5003Kà			01/07/2013
D65	solar standard CCT 6504K°			01/07/2013
F11	fluorescent narrow band CCT 4000K° (TL84)			01/07/2013
F2	cold white fluorescent CCT 4230K°			01/07/2013
F7	fluorescent broad band CCT 6500K°			01/07/2013

T60 - CIE standard observer

CIE average chromatic response definition

tabella cod.: T60

File codes list (Generic code): http://www.ebiz.enea.it/moda-ml/repository/codelist/v2018-1/gc_T60.xml

Code	Description	Adoption note	Version status	Date of insertion
31	CIE-1931			01/07/2013
64	CIE-1964			01/07/2013

T61 - duty or tax or fee type

duty or tax or fee type

Agency name: eBIZ

tabella cod.: T61

File codes list (Generic code): http://www.ebiz.enea.it/moda-ml/repository/codelist/v2018-1/gc_T61.xml

Code	Description	Adoption note	Version status	Date of insertion
BOL	stamp duty			01/07/2013
CUD	customs duty			01/07/2013
ENV	environmental tax			01/07/2013
FRE	no tax			01/07/2013
OTH	other tax charges			01/07/2013
VAT	value added tax			01/07/2013

T62 - duty or tax or fee category

duty or tax or fee category

Agency name: eBIZ

tabella cod.: T62

File codes list (Generic code): http://www.ebiz.enea.it/moda-ml/repository/codelist/v2018-1/gc_T62.xml

Code	Description	Adoption note	Version status	Date of insertion
AA	lower than standard rate			01/07/2013
E	tax not applicable			01/07/2013
H	higher than standard rate			01/07/2013
O	outside scope of tax			01/07/2013
S	standard rate			01/07/2013
Z	zero rate goods			01/07/2013

T8 - Modes of Transport

way of transport, in general or referred to the specified leg

Agency name: eBIZ

tabella cod.: T8

File codes list (Generic code): http://www.ebiz.enea.it/moda-ml/repository/codelist/v2018-1/gc_T8.xml

Code	Description	Adoption note	Version status	Date of insertion
1	MARITIME TRANSPORT			
10	Courier			01/07/2013
2	RAIL TRANSPORT			
3	ROAD TRANSPORT			
4	AIR TRANSPORT			
5	MAIL			
6	AIR + SHIP TRANSPORT			
8	INLAND WATER TRANSPORT			
9	MODE UNKNOWN			

T9 - ISO4217 - Currency

currency code

Agency name: ISO

tabella cod.: T9

File codes list (Generic code): http://www.ebiz.enea.it/moda-ml/repository/codelist/v2018-1/gc_T9.xml

Table not printed: there are 205 elements, more than the maximum specified for printing: 99.

Annex C

New or changed elements towards previous version

Changes or added elements (changes in description excluded; changes in aggregation notes and best practice included): 113

Test Type	Tag	Status	Item type	Changes related to
Attribute	AC_amount	NEW	AC amount	Has NEW attribute: data currency
Element(E)	AC_category Text	UPDATED	AC category text	Property: Length_Max Old value: 70 New value: 250
Attribute	additionalIdentifier	NEW	Additional Party Identifier	Has NEW attribute: numbering organisation code
Attribute	additionalIdentifier	NEW	Additional Party Identifier	Has NEW attribute: id Qualifier
Element(I)	additionalIdentifier	NEW	Additional Party Identifier	
Attribute	allowanceCharge	NEW	Allowance and Charge	Has NEW attribute: is Charge
Attribute	allowanceCharge	NEW	Allowance and Charge	Has NEW attribute: maximum quantity
Attribute	allowanceCharge	NEW	Allowance and Charge	Has NEW attribute: minimum quantity
Attribute	allowanceCharge	NEW	Allowance and Charge	Has NEW attribute: data currency
Attribute	allowanceCharge	NEW	Allowance and Charge	Has NEW attribute: unit of measure code
Element(E)	art	UPDATED	article identifier	Property: Length_Max Old value: 25 New value: 80
Attribute	art	UPDATED	article identifier	Its attribute: code list reference Property: Aggregation Note_English Old value: <i>this attribute should be ALTERNATIVE to the others</i> New value: <i>at least one out of this attribute and "numberingOrg" should be set</i>

Element()	attachment	NEW	attachment	
Child	attachment	NEW	attachment	Has NEW child of: file name
Child	attachment	NEW	attachment	Has NEW child of: external reference
Child	attachment	NEW	attachment	Has NEW child of: binary object
Attribute	binary Object	NEW	binary object	Has NEW attribute: encoding
Attribute	binary Object	NEW	binary object	Has NEW attribute: mime
Attribute	binary Object	NEW	binary object	Has NEW attribute: format
Attribute	binary Object	NEW	binary object	Has NEW attribute: character set
Element()	binary Object	NEW	binary object	
Child	buyer	NEW	Buyer (*)	Has NEW child of: Party identifier
Child	buyer	NEW	Buyer (*)	Has NEW child of: Additional Party Identifier
Attribute	buyer	NEW	Buyer (*)	Has NEW attribute: sender Party qualifier
Element()	characterSet Code	NEW	character set code	
Element()	characterSet	NEW	character set	
Child	colorCardItem	UPDATED	color card item	relationship with child: description Property: Cardmax Old value: 1 New value: 999
Child	colorCardItem	UPDATED	color card item	relationship with child: articles colour identifier Property: Aggregation Note_English Old value: New value: <i>multiple color values allowed if they differ for at least one of the numberingOrg and listName attributes</i>
Child	colorCardItem	UPDATED	color card item	relationship with child: articles colour identifier Property: Cardmax

				Old value: 1 New value: 2
Element(E)	deliveryPlace	UPDATED	delivery place	Property: Length_Max Old value: 40 New value: 250
Attribute	description	NEW	description	Has NEW attribute: In
Element(E)	description	UPDATED	description	Property: Length_Max Old value: 70 New value: 250
Attribute	despatchDate	NEW	despatch date	Has NEW attribute: date format
Element(I)	despatchDate	NEW	despatch date	
Element(I)	despatchPlace	NEW	despatch place	
Element(E)	email	UPDATED	e-mail	Property: Length_Max Old value: 80 New value: 250
Element(I)	encodingCode	NEW	encoding code	
Element(I)	encoding	NEW	encoding	
Child	externalReference	NEW	external reference	Has NEW child of: uri
Child	externalReference	NEW	external reference	Has NEW child of: format code
Child	externalReference	NEW	external reference	Has NEW child of: character set code
Child	externalReference	NEW	external reference	Has NEW child of: mime code
Child	externalReference	NEW	external reference	Has NEW child of: encoding code
Element(I)	externalReference	NEW	external reference	
Attribute	fileName	NEW	file name	Has NEW attribute: numbering organisation code

Element()	fileName	NEW	file name	
Element()	formatCode	NEW	format code	
Element()	format	NEW	format	
Attribute	note	UPDATED	general note	<p>Its attribute: numbering organisation code</p> <p>Property: Aggregation Note_English Old value: New value: <i>must be used to specify the organization that created the list of codes used in "noteLabel"</i></p>
Element()	idQualifier	NEW	id Qualifier	
Element()	isCharge	NEW	is Charge	
Element()	isURL	NEW	is URL	
Element(E)	legalName	UPDATED	Legal name	<p>Property: Length_Max Old value: 80 New value: 250</p>
Element(E)	itemID	UPDATED	line item number	<p>Property: Length_Max Old value: 6 New value: 40</p>
Attribute	lineN	UPDATED	line number	<p>Its attribute: VAT rate</p> <p>Property: Aggregation Note_English Old value: New value: <i>Deprecated, prefer dtScheme when available.</i></p>
Element()	ln	NEW	ln	
Element()	maxQty	NEW	maximum quantity	
Element()	mimeCode	NEW	mime code	
Element()	mime	NEW	mime	

Element(l)	program	NEW	progressive number	
Child	rawManufacturingOperation	UPDATED	raw manufacturing operation	relationship with child: reference document details Property: Cardmax Old value: 1 New value: 9
Child	rawManufacturingOperation	UPDATED	raw manufacturing operation	relationship with child: general note Property: Cardmax Old value: 19 New value: 99
Child	rawCode	UPDATED	raw material code	relationship with child: description Property: Cardmax Old value: 1 New value: 999
Child	rawCode	UPDATED	raw material code	relationship with child: description Property: Aggregation Note_English Old value: New value: <i>Raw material description</i>
Child	rawComponent	UPDATED	raw material component	relationship with child: reference document details Property: Cardmax Old value: 1 New value: 9
Child	rawComponent	UPDATED	raw material component	relationship with child: product quantity Property: BestPractice_English Old value: New value: <i>this element can have two instances only if the units of measure are different</i>
Child	rawComponent	UPDATED	raw material component	relationship with child: general note Property: Cardmax Old value: 19 New value: 99
Child	refDoc	NEW	reference document details	Has NEW child of: attachment
Child	refDoc	UPDATED	reference document details	relationship with child: document identifier Property: BestPractice_English Old value: New value: <i>numberingOrg indicates the role that produced the document id</i>

				<i>entifier (it is allowed to declare two different ones -e.g. customer and supplier - with two docID with different numberingOrg</i>
Child	RSCX header	UPDATED	RSCX header	relationship with child: general note Property: Cardmax Old value: 19 New value: 99
Child	RSCX header	UPDATED	RSCX header	relationship with child: reference document details Property: Aggregation Note_English Old value: New value: <i>At least one occurrence should contain a reference to the order it responds to (for example docType=ORD or OCH or BOR)</i>
Child	RSCX header	UPDATED	RSCX header	relationship with child: Third Party Property: Cardmax Old value: 1 New value: 5
Child	RSCX item	NEW	RSCX item	Has NEW child of: tax scheme
Child	RSCX item	UPDATED	RSCX item	relationship with child: reference document details Property: Cardmax Old value: 1 New value: 9
Child	RSCX item	UPDATED	RSCX item	relationship with child: Third Party Property: Cardmax Old value: 1 New value: 3
Child	RSCX item	UPDATED	RSCX item	relationship with child: general note Property: Cardmax Old value: 19 New value: 99
Child	RSCX item	UPDATED	RSCX item	relationship with child: reference document details Property: Aggregation Note_English Old value: <i>Use to link the line of the present document to the line of the order, use refDoc element; numberingOrg indicates the role that produced the document and such reference, customer or supplier (both might be reported through two instances of refDoc)</i> New value: <i>At least one occurrence should contain a reference to the order it responds to (for example docType=ORD or OCH or BOR)</i>
Child	RSCX item	UPDATED	RSCX item	relationship with child: product quantity Property: BestPractice_English

				Old value: New value: <i>this element can have two instances only if the units of measure are different</i>
Attr ib	season	NEW	season identifier	Has NEW attribute: code list reference
Attr ib	season	NEW	season identifier	Has NEW attribute: numbering organisation code
Attr ib	season	NEW	season identifier	Has NEW attribute: code list name
Attr ib	season	NEW	season identifier	Has NEW attribute: code list version
Child	subContractor	NEW	Sub-contractor (*)	Has NEW child of: Party identifier
Attr ib	subContractor	NEW	Sub-contractor (*)	Has NEW attribute: sender Party qualifier
Element(l)	subDept	NEW	department identifier	
Attr ib	legalRef	NEW	tax legal reference	Has NEW attribute: code list name
Attr ib	legalRef	NEW	tax legal reference	Has NEW attribute: numbering organisation code
Attr ib	legalRef	NEW	tax legal reference	Has NEW attribute: code list version
Attr ib	legalRef	UPDATED	tax legal reference	Its attribute: code list reference Property: Use Old value: <i>Required</i> New value: <i>Optional</i>
Child	dtScheme	UPDATED	tax scheme	relationship with child: general note Property: Cardmax Old value: 19 New value: 99
Element(E)	paymentText	UPDATED	terms of payment text	Property: Length_Max Old value: 40 New value: 250
Element(E)	invoiceText	UPDATED	terms of trade text	Property: Length_Max Old value: 70 New value: 250
Element(E)	method	UPDATED	test method identifier	Property: Length_Max Old value: 25 New value: 80
Child	thirdParty	NEW	Third Party (*)	Has NEW child of: Party identifier

Attr ib	thirdP arty	NE W	Third Par ty (*)	Has NEW attribute: sender Party qualifier
Chi ld	terms	UP DAT ED	Trade co nditions	relationship with child: Transport information Property: Cardmax Old value: 1 New value: 5
Ele m(E)	transC onditio nText	UP DAT ED	transport condition - text	Property: Length_Max Old value: 100 New value: 250
Chi ld	transIn fo	NE W	Transport informati on	Has NEW child of: despatch place
Chi ld	transIn fo	NE W	Transport informati on	Has NEW child of: despatch date
Chi ld	transIn fo	NE W	Transport informati on	Has NEW child of: effective delivery date
Attr ib	transIn fo	NE W	Transport informati on	Has NEW attribute: progressive number
Attr ib	price	NE W	unit price amount	Has NEW attribute: data currency
Ele m(E)	price	UP DAT ED	unit price amount	Property: Digits_Dec Old value: 2 New value: 4
Attr ib	uri	NE W	uri	Has NEW attribute: is URL
Ele m(l)	uri	NE W	uri	
Ele m(E)	yarnC harText	UP DAT ED	yarn char acteristic s text	Property: Length_Max Old value: 40 New value: 250
Chi ld	yarnM nfrOpe ration	UP DAT ED	yarn man ufacturin g operati on	relationship with child: general note Property: Cardmax Old value: 19 New value: 99
Chi ld	yarnM nfrOpe ration	UP DAT ED	yarn man ufacturin g operati on	relationship with child: reference document details Property: Cardmax Old value: 1 New value: 9
Ele m(E)	yarnO utWra pText	UP DAT ED	yarn oute r packing text	Property: Length_Max Old value: 40 New value: 250

Child	yarnCode	UPDATED	Yarn product code	relationship with child: description Property: Aggregation Note_English Old value: New value: <i>Product description</i>
Child	yarnCode	UPDATED	Yarn product code	relationship with child: description Property: Cardmax Old value: 1 New value: 999
Child	yarnProd	UPDATED	yarn product	relationship with child: yarn specifications Property: Cardmax Old value: 9 New value: 99
Child	yarnProd	UPDATED	yarn product	relationship with child: general note Property: Cardmax Old value: 19 New value: 99

Annex D

New or changed tables and codes towards previous version

Changes or added items (changes in CodeListAgencyName excluded; changes in adoption notes and code description included): 155

Test Type	Status	Table code	Table description	Code	Change description
Table	UPDATED	NT100	eBIZ TCFUpstream version		Description_English Old value: <i>eBIZ Moda-ML version</i> New value: <i>eBIZ TCFUpstream version</i>
Code	NEW	NT100		2018-1 (v2018-1)	
Code	NEW	NT100		draft (draft)	
Table	UPDATED	NT16	VAT rate or code		Generalities Old value: <i>VAT rate or code (deprecated, use dtScheme element)</i> New value: <i>VAT rate or code (DEPRECATED, use dtScheme element)</i>
Code	NEW	NT2		AU (Auditor)	
Code	NEW	NT2		CE (Certification authority)	
Code	NEW	NT2		SC (Sub contractor)	
Code	NEW	NT2		SM (Service/ePlatform manager)	
Code	NEW	NT6		EB (eBIZ)	
Code	UPDATED	NT6		ML (DEPRECATED)	adoption_note Old value: New value: <i>DEPRECATED</i>
Table	NEW	NT60	language, codes from ISO 639-1 (subset)		
Code	NEW	NT60		F (Female)	
Code	NEW	NT60		af (Afrikaans)	
Code	NEW	NT60		ar (Arabic)	

Co de	NEW	NT 60		<i>be</i> (Belarusian)	
Co de	NEW	NT 60		<i>bg</i> (Bulgarian)	
Co de	NEW	NT 60		<i>bn</i> (Bengali)	
Co de	NEW	NT 60		<i>bo</i> (Tibetan)	
Co de	NEW	NT 60		<i>bs</i> (Bosnian)	
Co de	NEW	NT 60		<i>ca</i> (Catalan, Valencian)	
Co de	NEW	NT 60		<i>cs</i> (Czech)	
Co de	NEW	NT 60		<i>da</i> (Danish)	
Co de	NEW	NT 60		<i>de</i> (German)	
Co de	NEW	NT 60		<i>el</i> (Greek, Modern (1453-))	
Co de	NEW	NT 60		<i>en</i> (English)	
Co de	NEW	NT 60		<i>eo</i> (Esperanto)	
Co de	NEW	NT 60		<i>es</i> (Spanish, Castilian)	
Co de	NEW	NT 60		<i>et</i> (Estonian)	
Co de	NEW	NT 60		<i>eu</i> (Basque)	
Co de	NEW	NT 60		<i>fa</i> (Persian)	
Co de	NEW	NT 60		<i>fi</i> (Finnish)	
Co de	NEW	NT 60		<i>fr</i> (French)	
Co de	NEW	NT 60		<i>ga</i> (Irish)	
Co de	NEW	NT 60		<i>gd</i> (Gaelic, Scottish Gaelic)	
Co de	NEW	NT 60		<i>gn</i> (Guarani)	
Co de	NEW	NT 60		<i>he</i> (Hebrew)	

Co de	NEW	NT 60		<i>hr</i> (Croatian)	
Co de	NEW	NT 60		<i>ht</i> (Haitian, Haitian Creole)	
Co de	NEW	NT 60		<i>hu</i> (Hungarian)	
Co de	NEW	NT 60		<i>hy</i> (Armenian)	
Co de	NEW	NT 60		<i>ia</i> (Interlingua (International Au xiliary Language Association))	
Co de	NEW	NT 60		<i>id</i> (Indonesian)	
Co de	NEW	NT 60		<i>is</i> (Icelandic)	
Co de	NEW	NT 60		<i>it</i> (Italian)	
Co de	NEW	NT 60		<i>ja</i> (Japanese)	
Co de	NEW	NT 60		<i>jv</i> (Javanese)	
Co de	NEW	NT 60		<i>ka</i> (Georgian)	
Co de	NEW	NT 60		<i>km</i> (Central Khmer)	
Co de	NEW	NT 60		<i>ko</i> (Korean)	
Co de	NEW	NT 60		<i>ku</i> (Kurdish)	
Co de	NEW	NT 60		<i>lb</i> (Luxembourgish, Letzeburge sch)	
Co de	NEW	NT 60		<i>lo</i> (Lao)	
Co de	NEW	NT 60		<i>lt</i> (Lithuanian)	
Co de	NEW	NT 60		<i>lv</i> (Latvian)	
Co de	NEW	NT 60		<i>mg</i> (Malagasy)	
Co de	NEW	NT 60		<i>mk</i> (Macedonian)	
Co de	NEW	NT 60		<i>mn</i> (Mongolian)	

Co de	NEW	NT 60		<i>mt</i> (Maltese)	
Co de	NEW	NT 60		<i>nl</i> (Dutch, Flemish)	
Co de	NEW	NT 60		<i>no</i> (Norwegian)	
Co de	NEW	NT 60		<i>pl</i> (Polish)	
Co de	NEW	NT 60		<i>pt</i> (Portuguese)	
Co de	NEW	NT 60		<i>ro</i> (Romanian, Moldavian, Mold ovan)	
Co de	NEW	NT 60		<i>ru</i> (Russian)	
Co de	NEW	NT 60		<i>se</i> (Northern Sami)	
Co de	NEW	NT 60		<i>sk</i> (Slovak)	
Co de	NEW	NT 60		<i>sl</i> (Slovenian)	
Co de	NEW	NT 60		<i>sm</i> (Samoan)	
Co de	NEW	NT 60		<i>so</i> (Somali)	
Co de	NEW	NT 60		<i>sq</i> (Albanian)	
Co de	NEW	NT 60		<i>sr</i> (Serbian)	
Co de	NEW	NT 60		<i>sv</i> (Swedish)	
Co de	NEW	NT 60		<i>sw</i> (Swahili)	
Co de	NEW	NT 60		<i>ta</i> (Tamil)	
Co de	NEW	NT 60		<i>th</i> (Thai)	
Co de	NEW	NT 60		<i>tr</i> (Turkish)	
Co de	NEW	NT 60		<i>uk</i> (Ukrainian)	
Co de	NEW	NT 60		<i>ur</i> (Urdu)	
Co de	NEW	NT 60		<i>uz</i> (Uzbek)	

Code	NEW	NT60		<i>vi</i> (Vietnamese)	
Code	NEW	NT60		<i>zh</i> (Chinese)	
Code	NEW	NT7		<i>CMK</i> (square centimetre)	
Code	NEW	NT7		<i>CMQ</i> (cubic centimetre)	
Code	NEW	NT7		<i>E37</i> (pixel)	
Code	NEW	NT7		<i>KWH</i> (kilowatthours)	
Code	NEW	NT7		<i>MMK</i> (square millimetre)	
Code	NEW	NT7		<i>MTK</i> (square metre)	
Code	NEW	NT7		<i>CO2TON</i> (ton of CO2)	
Table	UPDATE	NT7	unit of measure		OtherExternalReferenceURL Old value: New value: #http://docs.oasis-open.org/ubl/os-UBL-2.1/cl/gc/default/UnitOfMeasureCode-2.1.gc#
Table	UPDATE	NT7	unit of measure		Description_English Old value: <i>unity of measure</i> New value: <i>unit of measure</i>
Code	NEW	T21		<i>BOR</i> (blanket order)	
Code	NEW	T21		<i>CEO</i> (Certificate of origin)	
Code	NEW	T21		<i>CER</i> (Certificate)	
Code	UPDATE	T21		<i>CTR</i> (Contract)	Text_English Old value: <i>contract</i> New value: <i>Contract</i>
Code	NEW	T21		<i>MCI</i> (Visual merchandising instruction)	
Code	NEW	T21		<i>VMI</i> (visual merchandising instructions)	
Code	NEW	T41		1 (Agreed settlement)	
Code	NEW	T41		2 (Below specification goods)	
Code	NEW	T41		3 (Damaged goods)	

Co de	NEW	T4 1		4 (Short delivery)	
Co de	NEW	T4 1		7 (Payment on account)	
Co de	NEW	T4 1		8 (Returnable container charge included)	
Co de	NEW	T4 1		9 (Invoice error)	
Co de	NEW	T4 1		10 (Costs for draft)	
Co de	NEW	T4 1		11 (Bank charges)	
Co de	NEW	T4 1		12 (Agent commission)	
Co de	NEW	T4 1		14 (Wrong delivery)	
Co de	NEW	T4 1		15 (Goods returned to agent)	
Co de	NEW	T4 1		16 (Goods partly returned)	
Co de	NEW	T4 1		17 (Transport damage)	
Co de	NEW	T4 1		19 (Trade discount)	
Co de	NEW	T4 1		20 (Deduction for late delivery)	
Co de	NEW	T4 1		21 (Advertising costs)	
Co de	NEW	T4 1		22 (Customs duties)	
Co de	NEW	T4 1		23 (Telephone and postal costs)	
Co de	NEW	T4 1		24 (Repair costs)	
Co de	NEW	T4 1		25 (Attorney fees)	
Co de	NEW	T4 1		26 (Taxes)	
Co de	NEW	T4 1		30 (Direct payment to seller)	
Co de	NEW	T4 1		32 (Goods not delivered)	
Co de	NEW	T4 1		33 (Late delivery)	

Co de	NEW	T4 1		35 (Goods returned)	
Co de	NEW	T4 1		36 (Invoice not received)	
Co de	NEW	T4 1		37 (Credit note to debtor/not to us)	
Co de	NEW	T4 1		38 (Deducted bonus)	
Co de	NEW	T4 1		39 (Deducted discount)	
Co de	NEW	T4 1		40 (Deducted freight costs)	
Co de	NEW	T4 1		41 (Deduction against other invoices)	
Co de	NEW	T4 1		42 (Credit balance(s))	
Co de	NEW	T4 1		45 (Debit note to seller)	
Co de	NEW	T4 1		46 (Discount beyond terms)	
Co de	NEW	T4 1		48 (Allowance/charge error)	
Co de	NEW	T4 1		49 (Substitute product)	
Co de	NEW	T4 1		50 (Terms of sale error)	
Co de	NEW	T4 1		52 (Wrong invoice)	
Co de	NEW	T4 1		53 (Duplicate invoice)	
Co de	NEW	T4 1		54 (Weight error)	
Co de	NEW	T4 1		55 (Additional charge not authorized)	
Co de	NEW	T4 1		56 (Incorrect discount)	
Co de	NEW	T4 1		57 (Price change)	
Co de	NEW	T4 1		58 (Variation)	
Co de	NEW	T4 1		59 (Chargeback)	

Code	NEW	T4 1		65 (Settlement to agent)	
Code	NEW	T4 1		66 (Cash discount)	
Code	NEW	T4 1		70 (Wrong monetary amount resulting from incorrect free goods quantity)	
Code	NEW	T4 1		72 (Temporary special promotion)	
Code	NEW	T4 1		73 (Difference in tax rate)	
Code	NEW	T4 1		74 (Quantity discount)	
Code	NEW	T4 1		75 (Promotion discount)	
Code	NEW	T4 1		76 (Cancellation deadline passed)	
Code	NEW	T4 1		77 (Pricing discount)	
Code	NEW	T4 1		78 (Volume discount)	
Code	NEW	T4 1		79 (Sundry discount)	
Table	UPDATE	T4 1	type of Allowance or Charge		Generalities Old value: <i>coded specification of an Allowance or Charge</i> New value: <i>coded specification of an Allowance or Charge (elaborated from UNECE 4465)</i>
Code	NEW	T4 4		CO (company identification code)	